



ATARI FLASHBACK[®] 8

INSTRUCTION MANUAL

MODEL NO: AR3220



ATGAMES

AtGames Digital Media, Inc. www.atgames.net

IMPORTANT: READ BEFORE USE

In very rare circumstances, some people may experience epileptic seizures when viewing flashing lights or patterns in our everyday life. Flashing lights and patterns are also common to almost any video game. Please consult your physician before playing ANY video game if you have had an epileptic condition or seizure OR if you experience any of the following while playing - Altered vision, eye or muscle twitching, mental confusion or disorientation, loss of awareness of the surroundings or involuntary movements.

It is advised to take a 20-minute rest after 1 hour of continuous play.

Classic Game Console Appearance and Key List

The image below shows the location of the connectors and buttons. Each function is outlined below (the illustration is for reference only).

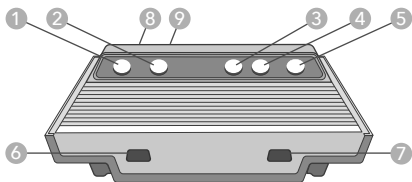

- 1 Power**
Turn the game console's power ON/OFF.
- 2 START (Original RESET Button)**
Press this button to begin most games.
- 3 Difficulty Button - Left Player**
Press this button to switch between one of two difficulty levels in most games.
- 4 Difficulty Button - Right Player**
Press this button to switch between one of two difficulty levels in most games.
- 5 SELECT**
Select game option.
- 6 Left Player Game Controller Jack**
Game controller connected to this jack controls games in 1-player games and controls the first player in 2-player games. Note that some 2-player games alternate use of the left player.
- 7 Right Player Game Controller Jack**
Game controller connected to this jack controls the second player in 2-player games.
- 8 AC Adaptor Jack (DC 5V)**
The power adaptor plugs into this port, then into your AC outlet.
- 9 AV Cable**
Audio and video output.

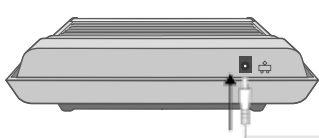

AC Adapter Specification

INPUT: 100V-240V
AC/50HZ-60HZ
OUTPUT: 5V DC/500mA
PLUG:

NOTE

- Must use the AC adapter included as power supply to the console.
- Do not connect the AC adapter to the power input other than the above specifications.
- AC adapter is not a toy.
- The socket-outlet shall be installed near the equipment and shall be easily accessible.

Wired Game Controller Appearance and Key List

The image below shows the appearance and key list of the wired game controllers (the illustration is for reference only).

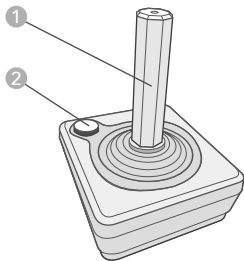

- 1 Joystick**
Push joystick to move.
- 2 BUTTON**
Press button for most in-game actions.

How to connect the console to a TV?

1. Connect the game console to TV using the enclosed AV cable.
2.  Press the power button on the game console after configuring the TV input to AV or Composite input.

NOTE: Display results will vary by TV. Consult your TV's manual to adjust Brightness, Sharpness, Contrast, Aspect Ratio, and other features for best display results.

Input Instruction

If your TV does not have a dedicated composite input, it may support such a connection through a shared component input. For TVs with shared component inputs, the diagram below indicates a typical setup, with the yellow composite video connector plugging into the green component video input. Refer to your TV's manual for additional information on available ports and how to change inputs once connected.

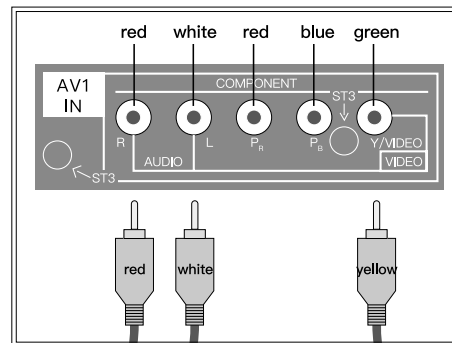

What can I do if my TV can only support HDMI input?

Check out AtGames Flashback Zone for further HDMI supported products <http://atgames.us/>.



What are the two controller ports on the console for?

These ports are for the included wired joysticks and optional paddle controllers. These ports are also compatible with original Atari 2600 wired joysticks and paddle controllers.

How to connect wired controllers?

For 1 player games: Connect a wired controller to the left controller port.
For 2 player games: Connect a second wired controller to the right controller port for player two.

How do I start playing?

1.  Press the button to turn on the game console.
2. Use the player 1 (P1) controller that is connected to the port to browse menu and select game. Move the joystick of P1 controller left and right to navigate the menu pages, and move up and down to highlight games on each page.
3.  Press the button on the controller to enter the selected game.



How do I play the 3- and 4-player games?

The 3- and 4-player games are designed for paddle controllers. Please plug your paddle controllers into each controller port on the game console.

How do I adjust the game level?

 Press the button on the game console.   Press the button to begin the adjusted level.

How do I go back to game menu while playing the game?

 +  Press the START button and SELECT button on the console simultaneously, and the screen will go back to the game menu.

What do I do when the controller is not working?

If you only have a controller plugged into the P2 socket, turn off your console and connect the controller to the P1 (left) controller port. Then, turn on the console and try it again.

What do I do when the power supply is not working?

You might be using the wrong AC adapter. Please use the one included in the package, which is rated for 5V/500mA.

How do I play with wireless controllers?

IR-based controllers from previous AtGames' consoles are not supported.

This device complies with Part 15 of the FCC Rules. Operation is subject to the following two conditions: (1) this device may not cause harmful interference, and (2) this device must accept any interference received, including interference that may cause undesired operation.

PROBLEM	SOLUTION
No picture on the screen	Connect the AC adapter Connect the A/V cable Turn the console unit On Turn the TV On Set the TV to AV input
Screen flickers or no color	Adjust TV color controls
No game sound	Increase or turn on the TV volume Connect the AV cable
Picture on TV screen is unsteady	Adjust the vertical and horizontal hold controls on your TV until the picture becomes steady Connect the AV cable
Picture is blinking or distorted	Power Off the console and then power On the console
Picture background color varies at the beginning or end of the game.	This is normal. Press START to enter or restart the game.

Safety Notice

- Do not submerge the game console in water or expose it to extreme heat or to strong magnetic fields. Doing so may cause permanent damage to your game player.
- Always use dry towel to clean the game console and controllers.
- Transformers suitable for indoor use only. Transformers and power supplies for toys are not intended to be used as toys, and the use of these products by children shall be under the full supervision of parents.

Warning

Changes or modifications not expressly approved by the party responsible for compliance could void the user's authority to operate the equipment.

NOTE

This equipment has been tested and found to comply with the limits for a Class B digital device, pursuant to Part 15 of the FCC Rules. These limits are designed to provide reasonable protection against harmful interference in a residential installation. This equipment generates, uses and can radiate radio frequency energy and, if not installed and used in accordance with the instructions, may cause harmful interference to radio communications. However, there is no guarantee that interference will not occur in a particular installation. If this equipment does cause harmful interference to radio or television reception, which can be determined by turning the equipment off and on, the user is encouraged to try to correct the interference by one or more of the following measures:

- Reorient or relocate the receiving antenna.
- Increase the separation between the equipment and receiver.
- Connect the equipment into an outlet on a circuit different from that to which the receiver is connected.
- Consult the dealer or an experienced radio/TV technician for help

Repair and Exchange Service

If the unit is damaged due to its improper use or simply wear and tear, and if the place where the product was originally purchased can't do an exchange of this product, a standard repair and exchange program may help. Please visit http://www.atgames.us/Repair_c2.htm for more details about the repair and exchange program.

Game Description

Game title: 3-D Tic-Tac-Toe

MENU TITLE: 3-D TIC-TAC-TOE

Place four X's or four O's in one horizontal, vertical, or diagonal row, or through all the panes. Play against an opponent or against the computer. To win, complete a row first.

Game title: Adventure

MENU TITLE: ADVENTURE

Rescue the Enchanted Chalice stolen by an evil magician and return it to the Golden Castle without getting eaten by evil dragons.

Game title: Adventure II

MENU TITLE: ADVENTURE II

In this remixed sequel, once again rescue the Enchanted Chalice stolen by an evil magician and place it inside the Golden Castle.

Game title: Air Raiders™

MENU TITLE: AIR RAIDERS

As the pilot of your bomber, your mission is to blast the enemy out of the sky. But be sure to keep track of your fuel and ammo, you may have to land to refuel.

Game title: Air•Sea Battle

MENU TITLE: AIR•SEA BATTLE

The object of this game is to score points by hitting moving objects. Air-Sea Battle is made of six different shooting games that total 27 game variations.

Game title: Aquaventure

MENU TITLE: AQUAVENTURE

Discover what the ocean depths hide as you dive to retrieve the hidden treasure. Along the way you must avoid fish, sea horses, and other underwater creatures attempting to block your path.

Game title: Armor Ambush™

MENU TITLE: ARMOR AMBUSH

Battlefield action with maneuverable tanks! A new battlefield every round!

Game title: Asteroids®

MENU TITLE: ASTEROIDS

Destroy as many asteroids as you can to keep your ship safe. Watch out for satellites and UFOs as well!

Game title: Astroblast™

MENU TITLE: ASTROBLAST

The excitement of defending your planet! Falling meteors, missiles, and enemy spacecraft all might knock out your position, but you have both automatic and semi-automatic firing sequences to defend against the onslaught.

Game title: Atari Climber

MENU TITLE: ATARI CLIMBER

A home run ball has landed on top of the roof of a building and you'll need to get it back. On your way up, you'll need to avoid moving obstacles. Hurry, as time is of the essence!

Game title: Backgammon

MENU TITLE: BACKGAMMON

Backgammon has four skill levels and follows the full rules of the game. There are also four variations of the game acey-deucey.

Game title: Basketball

MENU TITLE: BASKETBALL

Get ready for a fast-paced game of one-on-one basketball!

Game title: Black Jack

MENU TITLE: BLACK JACK

It's real casino-style blackjack where you and up to two of your buddies can try your luck against the computer dealer. The object of the game is to obtain a hand of cards that adds up to total higher than the dealer does, without going over 21. Up to three players can compete at the same time.

Game title: Bowling

MENU TITLE: BOWLING

It's bowling fun for one or two players. Choose between curve ball, steerable ball, and straight ball variations!

Game title: Breakout®

MENU TITLE: BREAKOUT

A brick wall appears at the top of the screen, and your mission is to smash it off the playfield, one brick at a time! Up to four players can compete at the same time.

Game title: Human Cannonball™

MENU TITLE: CANNONBALL

Carefully judge angle, speed, and distance to launch your human cannonball to the target.

Game title: Canyon Bomber®

MENU TITLE: CANYON BOMBER

Fly over a canyon full of colored bricks. Drop bombs on more bricks than your opponent.

Game title: Centipede®

MENU TITLE: CENTIPEDE

Aim your magic wand and shoot sparks to stop the slithering Centipede, the poisonous scorpion, mischievous spider, and pesky flea in their tracks!

Game title: Super Challenge™ Baseball

MENU TITLE: CHALL BASEBALL

Two players can capture the excitement of real baseball. Nine full innings of baseball - with extra innings if you need them. Pitch curve balls, hit, run, steal bases...even turn over double and triple plays.

Game title: Super Challenge™ Football

MENU TITLE: CHALL FOOTBALL

Realistic gridiron action for two players! Choose your play option on both offense and defense. The scoreboard keeps you posted on quarter, downs, time remaining, and the score.

Game title: Championship Soccer

MENU TITLE: CHAMP SOCCER

Score more goals than your opponent in this fast-paced soccer game.

Game title: Chase It!

MENU TITLE: CHASE IT!

Chase It is a game of chasing the red squares that appear randomly on the screen. It's blue against black! The goal is to reach the squares before your opponent. Whoever collects 99 squares first wins. Chase it is an exciting and challenging game that can be enjoyed by the whole family!

Game title: Circus Atari®

MENU TITLE: CIRCUS ATARI

Bounce clowns on a seesaw to pop all the balloons. Be sure to catch the clown on his way down!

Game title: Combat®

MENU TITLE: COMBAT

Arm yourself against your opponent with tanks, planes, or fighter jets in diverse stages in this two player game. Blast your opponent as many times as you can for the highest score.

Game title: Combat® Two

MENU TITLE: COMBAT TWO

Battle against your opponent's tank for control of an expansive terrain in this two player game.

Game title: Crystal Castles®

MENU TITLE: CRYSTAL CASTLES

Help Bentley Bear collect gems throughout various castle levels to escape Berthilda the Witch's evil clutches. Avoid the enemies, except when you wear the magic hat!

Game title: Dark Cavern™

MENU TITLE: DARK CAVERN

Relentless robots are the attackers in the Dark Cavern. Eliminate one robot and it is replaced by an even smarter one. People-sized spiders, spider webs, and bats also spell trouble. Use your laser gun to destroy the attackers and score points.

Game title: Demons to Diamonds™

MENU TITLE: DEMNS TO DIMNDS

Shoot demons whose color matches that of your gun. If successful, the demon transforms into a diamond, which can then be shot for even more points. Take care, because shooting a demon with the wrong color transforms it into a skull!

Game title: Desert Falcon

MENU TITLE: DESERT FALCON

You are the royal Desert Falcon on a quest for precious gems and Egyptian hieroglyphics hidden in an endless desert. Watch out for the flying beasts, blazing firepots, and Howling Sphinxes as they guard the jewels you seek.

Game title: Dodge 'Em

MENU TITLE: DODGE 'EM

Steer your car at high speed around a maze to collect dots. Be sure to avoid the other car!

Game title: Double Dunk™

MENU TITLE: DOUBLE DUNK

Score the most baskets in this sophisticated two-on-two, half-court basketball game.

Game title: SwordQuest: Earthworld™

MENU TITLE: EARTHWORLD

As you explore EarthWorld, you will traverse 12 rooms, each named after a sign of the zodiac. You will encounter danger such as the horns of a charging Taurus bull, and you will be called upon to demonstrate your skill and ingenuity. A variety of magical objects will assist you in the challenging journey ahead. By leaving the right combination of objects in the right zodiac chamber, you'll discover illuminating clues.

Game title: Escape It!

MENU TITLE: ESCAPE IT!

Escape It is a one or two player game where the object is to escape from the ever changing maze.

Game title: Fatal Run

MENU TITLE: FATAL RUN

Drive through all 32 levels to release the life-saving satellite. Along the way you must distribute the radiation vaccine throughout the major cities and collect the pieces of a launch code. If you complete the code and all levels, the satellite launches, and you win the game!

Game title: SwordQuest: Fireworld™

MENU TITLE: FIREWORLD

In this second game in the SwordQuest series, you enter FireWorld as a mighty warrior. Your skill and courage will be tested with dangerous trials and obstacles. The object of the game is to solve the puzzle.

Game title: Flag Capture

MENU TITLE: FLAG CAPTURE

Find the flag hidden somewhere in a 9x6 grid of squares. Clues under each square can tell you how far you are from the flag or in which direction it lays. Watch out for the bombs!

Game title: Football

MENU TITLE: FOOTBALL

This four-on-four football game focuses on high scoring touchdowns and defensive safeties. Field goals are not included, so go for the big score in this two player game!

Game title: Frog Pond

MENU TITLE: FROG POND

Leap and catch as many insects as you can with your hungry frog's tongue.

Game title: Frogger

MENU TITLE: FROGGER

It's tough to be a frog! Life isn't all lazy days and lily pads- it abounds with dangers. In fact, every leap Frogger takes could be his last! Help Frogger survive some perils, and hop Frogger home to safety.

Game title: Frogs & Flies™

MENU TITLE: FROGS & FLIES

An exciting and fun-filled fantasy for the younger set. Frogs and Flies gives you complete control over jumping frog and scoring action as you try to catch the elusive flies! Great game of the young - challenging for everyone.

Game title: Front Line™

©TAITO CORP.1982

MENU TITLE: FRONT LINE

Single-handedly take on the bad guys and knock out their fortress with your soldier. Start out on foot, but find the tanks and create even more mayhem.

Game title: Fun with Numbers

MENU TITLE: FUN WITH NUMBERS

Complete the equation by selecting the correct number. Pick between addition, subtraction, multiplication, and division.

Game title: Golf

MENU TITLE: GOLF

It's nine holes of golf, where you control the direction and the power of your shot. Watch out for the hazards!

Game title: Gravitar®

MENU TITLE: GRAVITAR

The evil Gravitar has conquered four galaxies, each made up of three solar systems. Fight against gravity and break Gravitar's hold on the 12 solar systems under his power by destroying all bunkers on every planet, or by setting off the reactor in the alien reactor base.

Game title: Hangman

MENU TITLE: HANGMAN

Complete the Hangman word before you make 11 incorrect letter guesses.

Game title: Haunted House®

MENU TITLE: HAUNTED HOUSE

To escape the haunted house, find the pieces of a magic urn. Along the way, you'll encounter terrifying monsters like hairy tarantulas, vampire bats, and a ghost.

Game title: Return to Haunted House

MENU TITLE: HAUNTED HOUSE II

Find the skull of old man Graves and return it to the crypt under the cemetery by utilizing various keys and tools to explore the house and avoid the ghosts.

Game title: H.E.R.O.

MENU TITLE: HERO

Guide R. Hero through caverns filled with flying critters, tentacles, moving walls, and other dangers. He's equipped with a jetpack, laser beam, and a limited supply of dynamite, all of which will be needed to negotiate a path to his ultimate goal, the trapped miners.

Game title: Home Run

MENU TITLE: HOME RUN

Play a scaled-back, fast-paced version of baseball, America's favorite pastime.

Game title: Indy 500™

MENU TITLE: INDY 500

Steer your car around one of the many tracks, racing around hairpin turns to get to the finish line before your opponent.

Game title: International Soccer™

MENU TITLE: INTL SOCCER

A two-player game that adapts the fast-paced movement of soccer to your video system. Realistic scrolling field action - feint, pass...and score! All accompanied by exciting sound effects.

Game title: Jungle Hunt™

©TAITO CORP.1982

MENU TITLE: JUNGLE HUNT

Help Sir Dudley Dashly swing on vines, swim through crocodile-infested waters, jump and duck through a landslide of boulders, and jump over cannibals to save his wife, Lady Penelope Dashly.

Game title: KABOOM!

MENU TITLE: KABOOM!

You're about to face the world's most unpredictable and relentless "Mad Bomber." He hates losing as much as you love winning. So, to keep him frowning, grab your water buckets to catch and extinguish his falling bombs!

Game title: Maze Craze

MENU TITLE: MAZE CRAZE

Control a blue or red cop and patrol a maze of robber-infested city blocks as you try to make it to the exit.

Game title: Millipede®

MENU TITLE: MILLIPEDE

Blast the creepy, crawly bugs - jumping spiders, buzzing bees, bouncing beetles, mosquitoes, dragonflies, inchworms, and earwigs - that have invaded your little garden patch. But watch out, the millipedes - cousins to the famed centipede - are the most insidious insects of all!

Game title: Miniature Golf

MENU TITLE: MINIATURE GOLF

Play a nine hole mini golf course, complete with moving obstacles. To beat the par for each hole, you'll need a good sense of timing, along with an ability to judge distance. Win by getting the lowest score.

Game title: Miss It!

MENU TITLE: MISS IT!

Miss It! is a one player game where the object is to keep the square away from all the other objects that are bouncing around the screen. The longer the game goes on the crazier it gets. The game ends when you are touched by one of the other objects. How long can you last?

Game title: Missile Command®

MENU TITLE: MISSILE COMMAND

Defend your cities and missile base from waves of ballistic and cruise missiles.

Game title: MotoRodeo

MENU TITLE: MOTORODEO

Use your monster truck to power through death-defying jumps, car crushing, wall smashing, mud plowing, and more. To be king of the road, you'll have to outscore your competitor in this most dangerous obstacle course.

Game title: Night Driver™

MENU TITLE: NIGHT DRIVER

You're in the driver's seat and the track is just ahead of you. All you have to do is accelerate and steer your car through one of the four tracks. Each time you veer off the track and hit one of the pylons or hit an oncoming car, you'll crash. How far can you get before time runs out?

Game title: Off the Wall

MENU TITLE: OFF THE WALL

Play as Kung Fu Lu in your quest to crush an ancient, evil wall guarded by a mystical dragon and cunning blackbird. Use your staff to deflect the dragon's spell balls and destroy the wall.

Game title: Outlaw

MENU TITLE: OUTLAW

As a gunslinger, take aim to shoot targets or your opponent's gunslinger.

Game title: Pitfall!

MENU TITLE: PITFALL!

Guide Pitfall Harry through a maze of jungle scenes, jump over or avoid many deadly dangers, and grab the most treasures in the shortest possible time.

Game title: Polaris™

©TAITO CORP.1980

MENU TITLE: POLARIS

You're the commander of a Polaris class nuclear submarine and your mission is to defend your country from enemy attack. In your battle, you will be required to defend against wave-after-wave of enemy planes and dive bombers. To make matters worse, the enemy has sent their own subs and destroyers. In the course of your battles, you will need to maneuver through dangerous channels full of mines!

Game title: Pong® (Video Olimpics)

MENU TITLE: PONG

Compete in classic ball and paddle games like Pong, Soccer, Hockey, Handball, Volleyball, Basketball, and more!

Game title: Pressure Cooker

MENU TITLE: PRESSURE COOKER

Help Short-Order Sam fill each order with the proper combination of tomatoes, onions, lettuce, and cheese. And don't forget the bun! Be sure to rush the completed orders to the Wrapping Room as fast as you can.

Game title: Radar Lock

MENU TITLE: RADAR LOCK

The safety of a nearby aircraft carrier is in your hands. You are the ace of a supersonic F-22, the latest, most powerful airborne weapon yet created. Your allies are nowhere in sight, so it's up to you to clear the skies of enemy interceptors, stealth fighters, and bombers!

Game title: River Raid

MENU TITLE: RIVER RAID

Your mission is to score as many points as possible by destroying enemy tankers, helicopters, fuel depots, jets, and bridges before your jet crashes or runs out of fuel.

Game title: Realsports® Baseball

MENU TITLE: RS BASEBALL

Hit a home run, make a spectacular catch, or force a triple play! Here's your chance to prove your skills on the baseball diamond. You control the ballplayers and the strategy in this sophisticated, action-packed sports simulation.

Game title: Realsports® Basketball

MENU TITLE: RS BASKETBALL

It's fast-breaking, two-on-two basketball excitement! Shoot the ball in the basket and score more points than your opponent.

Game title: Realsports® Soccer

MENU TITLE: RS SOCCER

Fast moving player-control lets you kick, pass, and dribble the ball down the field, around your opponents, and on to victory!

Game title: Realsports® Volleyball

MENU TITLE: RS VOLLEYBALL

Judge the height of the ball from its shadow in this fast-paced game of volleyball. As the sun sets, the shadow disappears, and you're on your own!

Game title: Saboteur®

MENU TITLE: SABOTEUR

Take the role of cybernetic life-form Hotot, who has discovered an alien missile base hidden on his planet. Manned by strange blue aliens, these evil intruders are using the planet as a launching site for their deadly warhead, which is poised to destroy the galaxy's power source. With the help of the bird-like Gorfons, you must destroy the warhead, and prevent the destruction of the galaxy in this multi-level shooter!

Game title: Save Mary

MENU TITLE: SAVE MARY

User your crane to drop blocks for Mary to climb on top of and escape the rising water level!

Game title: Sea Battle™

MENU TITLE: SEA BATTLE

Lots of action on the high seas, including fleets of ships, mines, and battle sounds. A game that requires creative strategy to win.

Game title: Secret Quest

MENU TITLE: SECRET QUEST

Vicious creatures now occupy eight vital space stations in their effort to conquer our peaceful solar system. It is up to you to destroy these locations and their evil inhabitants in order to save the human race. It's furious, non-stop action, and you'll need speed, courage, combat skills, and a sharp sense of directions.

Game title: Shield Shifter

MENU TITLE: SHIELD SHIFTER

Shoot your way through the shifting shields to give yourself a clean shot at the attacking Alien Queen!

Game title: Sky Diver

MENU TITLE: SKY DIVER

You're ready for the big jump! The longer you can wait to open your parachute, the more points you score. Steer your parachute against the wind to guide yourself towards the bull's-eye.

Game title: Slot Machine

MENU TITLE: SLOT MACHINE

Standard slot machine rules apply in this Atari video adaptation. Choose from a traditional jackpot type, in which you win based on which three symbols show up in the center, or a payoff game, in which additional coins allow a payoff if a winning combination shows up in the top, bottom, or diagonal lines.

Game title: Slot Racers

MENU TITLE: SLOT RACERS

The goal of this game is to drive a slot car around a maze and shoot your opponent more times than they shoot you.

Game title: Solaris

MENU TITLE: SOLARIS

Save the brave Solaris Pioneers from the vicious Zylon fleet! Speed your StarCruiser through the galaxy, firing photon torpedoes to show them you mean business. Blast Cobra Ships, Star Pirates, and Mechnoids before they blast you!

Game title: Space Attack™

MENU TITLE: SPACE ATTACK

It's you and your squadron against the attacking aliens. Control the strategy and the action for defending your Mother ship. Pinpoint alien attackers, then go to a close-up pilot's view for battle!

Game title: Space Invaders™

©TAITO CORP. 1978

MENU TITLE: SPACE INVADERS

You are at war with invaders from space who are threatening the earth! Your objective is to destroy these invaders by firing your laser cannon. You must wipe out the invaders either before they reach the bottom of the screen or before they hit you three times with their laser bombs.

Game title: Space War

MENU TITLE: SPACE WAR

Blast off into space with 17 game variations for one or two players. Take control of your starship and penetrate the boundaries of strange galaxies. Drift invisibly through hyperspace, but beware of the gravity of a strange sun.

Game title: Sprintmaster

MENU TITLE: SPRINTMASTER

Choose your track, from practice-caliber squares to the curvaceous championship courses. Rev up at the starting line, and take off! You'll need a delicate touch and a cool head to avoid sliding into the wall on those sharp turns.

Game title: Star Ship

MENU TITLE: STAR SHIP

Destroy as many spacecraft and robots as possible within the time limit, all while avoiding asteroids and other objects as you try to cover the greatest distance possible in one of three included game variations.

Game title: Star Strike™

MENU TITLE: STAR STRIKE

Hair-trigger action as you hurtle your spaceship through a trench to destroy the alien force that is threatening the planet earth! Enemy starships try to blast you into bits as you bomb their alien missile silos. Three-dimensional action.

Game title: Steeplechase

MENU TITLE: STEEPLCHASE

Ride your horse against up to three other friends in racing and hurdle games.

Game title: Stellar Track™

MENU TITLE: STELLAR TRACK

Destroy the alien menace before time or energy runs out in this classic game of strategy.

Game title: Street Racer

MENU TITLE: STREET RACER

Street Racer features car racing, slalom skiing, jet shooting, number crunching, and scoop ball games for up to four players!

Game title: Submarine Commander® (Sub Commander)

MENU TITLE: SUB COMMANDER

You are at the helm of a submarine equipped with radar, sonar depth charge indicators, torpedoes, and fuel and temperature gauges. As commander of the submarine, you must sink the enemy ships before running out of fuel!

Game title: Super Baseball

MENU TITLE: SUPER BASEBALL

Take to the field and outscore the other team in this sophisticated baseball game.

Game title: Super Breakout®

MENU TITLE: SUPER BREAKOUT

It's super-powered brick-breaking fun! Try your hand at Breakout, Cavity, Double, Progressive, or Children's Versions.

Game title: Super Football

MENU TITLE: SUPER FOOTBALL

It's five-on-five action in this sophisticated football game.

Game title: Surround

MENU TITLE: SURROUND

Control a moving wall to trap your opponent before they trap you. Watch out, because you can crash into your own wall! And if drawing is more your speed, try out the video graffiti mode.

Game title: Sword Fight™

MENU TITLE: SWORD FIGHT

Two swordfighters face off. Attack, feint, block, strike!

Game title: Tempest®

MENU TITLE: TEMPEST

Clear the screen of enemies on closed tubes or open playfields. Move freely along the edges of the playfield to target and shoot each enemy. If you're in a tight spot, use your Superzapper to clear the screen!

Game title: Video Checkers

MENU TITLE: VIDEO CHECKERS

Compete against another player or the computer in regular, or give away, checkers.

Game title: Video Chess

MENU TITLE: VIDEO CHESS

Compete against the computer in this classic game of chess.

Game title: Video Pinball

MENU TITLE: VIDEO PINBALL

Hit bumpers, spinners, targets, and rollovers to rack up points!

Game title: Warlords®

MENU TITLE: WARLORDS

Destroy the other three warlords before your warlord is destroyed by moving your catapult around your castle and catching or blocking the boulder to return fire.

Game title: SwordQuest: Waterworld™

MENU TITLE: WATERWORLD

In this third game in the SwordQuest series, there are seven puzzle-based rooms. Scattered throughout these rooms are 16 magical objects that are related to each other and the seven rooms. Isolating the rooms from each other are three skill-and-action tests that you'll need to master in order to successfully enter a room and correctly manipulate all of its objects.

Game title: Wizard

MENU TITLE: WIZARD

Control a wizard as you attempt to destroy an enemy imp.

Game title: Yars' Return

MENU TITLE: YARS' RETURN

Once again take to your Yar fly simulator to break a path through the shield and destroy the Qotile with a blast from the Zorlon Cannon!

Game title: Yars' Revenge®

MENU TITLE: YARS' REVENGE

Use your Yar fly simulator to break a path through the shield and destroy the Qotile with a blast from the Zorlon Cannon!

Find More Classics at www.atgames.net

ATGAMES

© 2017 AtGames Digital Media, Inc.

www.atgames.net

All rights reserved.

Made in China.

© 2017 Atari Interactive, Inc.

Atari and Atari logo are trademarks owned by Atari Interactive, Inc. All individual Atari game names and logos are trademarks or registered trademarks of Atari Interactive, Inc. or its affiliates. All other trademarks are the property of their respective owners.

Distributed by AtGames under license from Atari, Inc.

© 2017 Activision Publishing, Inc. ACTIVISION is a registered trademark of Activision Publishing, Inc. All other trademarks and trade names are the property of their respective owners, including in some cases Activision Publishing, Inc.

SPACE INVADERS™© TAITO CORPORATION 1978 ALL RIGHTS RESERVED.

JUNGLE HUNT™© TAITO CORPORATION 1982 ALL RIGHTS RESERVED.

FRONT LINE™© TAITO CORPORATION 1982 ALL RIGHTS RESERVED.

POLARIS™© TAITO CORPORATION 1980 ALL RIGHTS RESERVED.

The versions of SPACE INVADERS™, JUNGLE HUNT™, FRONT LINE™, and POLARIS™ included in the Atari Flashback® 7 are based on those created for the ATARI 2600® and therefore may differ in appearance and performance from the original arcade and console editions developed by TAITO Corporation.

©Konami Digital Entertainment



Copyright Good Deal Games, Inc.

M Network™ Games® 2017 Intellivision Productions, Inc. All rights reserved. All trademarks are the property of their respective owners.

The content of this document is subject to change without notice.