

HUAWEI FIT UG_V1.0

HUAWEI FIT UG_V1.0

Issue **01**
Date **2016-11-03**

Copyright © Huawei Technologies Co., Ltd. 2016. All rights reserved.

No part of this document may be reproduced or transmitted in any form or by any means without prior written consent of Huawei Technologies Co., Ltd.

Trademarks and Permissions



and other Huawei trademarks are trademarks of Huawei Technologies Co., Ltd.

All other trademarks and trade names mentioned in this document are the property of their respective holders.

Notice

The purchased products, services and features are stipulated by the contract made between Huawei and the customer. All or part of the products, services and features described in this document may not be within the purchase scope or the usage scope. Unless otherwise specified in the contract, all statements, information, and recommendations in this document are provided "AS IS" without warranties, guarantees or representations of any kind, either express or implied.

The information in this document is subject to change without notice. Every effort has been made in the preparation of this document to ensure accuracy of the contents, but all statements, information, and recommendations in this document do not constitute a warranty of any kind, express or implied.

Huawei Technologies Co., Ltd.

Address: Huawei Industrial Base
Bantian, Longgang
Shenzhen 518129
People's Republic of China

Website: <http://www.huawei.com>

Email: support@huawei.com

Contents

1 Quick start	1
1.1 Overview	1
1.2 Using the watch	2
1.3 Wearing the watch	2
1.4 Charging the watch	2
1.5 Pairing your watch with your phone	5
1.6 Power on/off and restart	6
1.7 Gestures	7
1.8 Screen operations	7
1.9 Icons	8
2 Fitness and health	11
2.1 Recording and sharing your fitness data	11
2.2 Monitoring your heart rate	12
2.2.1 Testing your heart rate	12
2.2.2 Broadcasting your heart rate	14
2.2.3 Using the heart rate limit interval	15
2.3 Starting a single exercise session	16
2.3.1 Starting an exercise on the watch	16
2.3.2 Viewing exercise results on the watch	18
2.3.3 Starting an exercise in the Huawei Wear app	20
2.3.4 Viewing exercise results in the Huawei Wear app	21
2.4 Starting your running training	22
2.4.1 Creating a training plan	22
2.4.2 Starting training	24
2.4.3 Viewing training results	25
2.5 Monitoring your sleep	26
3 Messaging assistant	27
3.1 Message alerts	27
3.2 Rejecting or muting incoming calls	29
3.3 Alarms	30
4 Settings	32
4.1 Changing personal information	32

4.2 Changing the watch face	33
4.3 Setting the backlight	33
4.4 Restoring factory settings	34
4.5 Updating your watch and app	34
4.6 Obtaining the watch information	35
5 Product maintenance	36
5.1 Saving battery life	36
5.2 Changing the watch strap	36
5.3 Water and dust resistance	37
5.4 Cleaning your watch	38
5.5 Caring for your watch	38

1 Quick start

- 1.1 Overview
- 1.2 Using the watch
- 1.3 Wearing the watch
- 1.4 Charging the watch
- 1.5 Pairing your watch with your phone
- 1.6 Power on/off and restart
- 1.7 Gestures
- 1.8 Screen operations
- 1.9 Icons

1.1 Overview

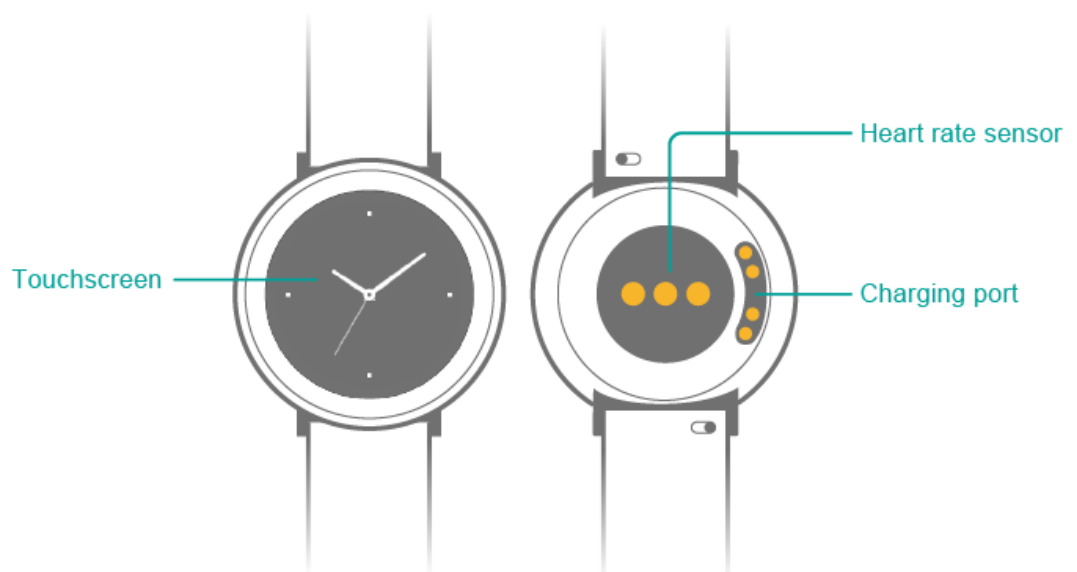

1.2 Using the watch

Wear your watch on your wrist and pair it with your phone for exercise, heart rate monitoring, sleep monitoring, and instant notifications.

- **Exercise**

Make exercise plans and provide scientific suggestions.

- **Heart rate monitoring**

Automatically monitor your heart rate at all times.

- **Sleep monitoring**

Automatically identify your sleep status and record your sleep data.

- **Instant notifications**

Raise your wrist to view incoming calls, emails, SMS messages, and WeChat messages.

1.3 Wearing the watch

Wear your watch and make sure it fits comfortably around your wrist. Your heart rate data may be affected if you wear your watch too tight or loose.

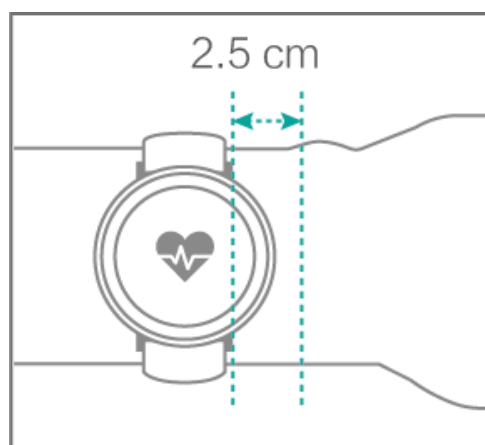

 **NOTE**

- If you wear your watch too tight, your blood circulation and the heart rate data may be affected.
- Do not damage the heart rate sensor on the back of your watch.
- Your watch is made of professional materials and has passed rigorous skin allergy tests. If your skin feels uncomfortable when wearing your watch, take it off and consult a doctor.

1.4 Charging the watch

Charging

Your watch comes with a magnetic charging cradle and USB cable, which can be used with a standard charger (within 5 V/2 A) to charge your watch.

 **NOTE**

- On your first use, remove the transparent protective film from the back of your watch.
- Do not use a mobile power supply to charge your watch.

1. Connect the charging cradle and power adapter using the USB cable. Plug in the power adapter.

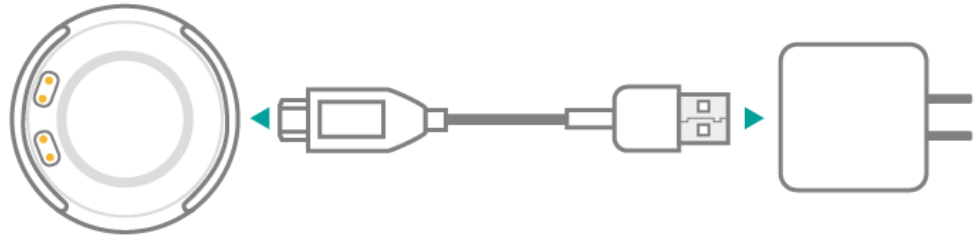

2. Rest your watch on top of the charging cradle, ensuring that the contacts on your watch and cradle are aligned. Wait until the charging icon appears on your watch screen.

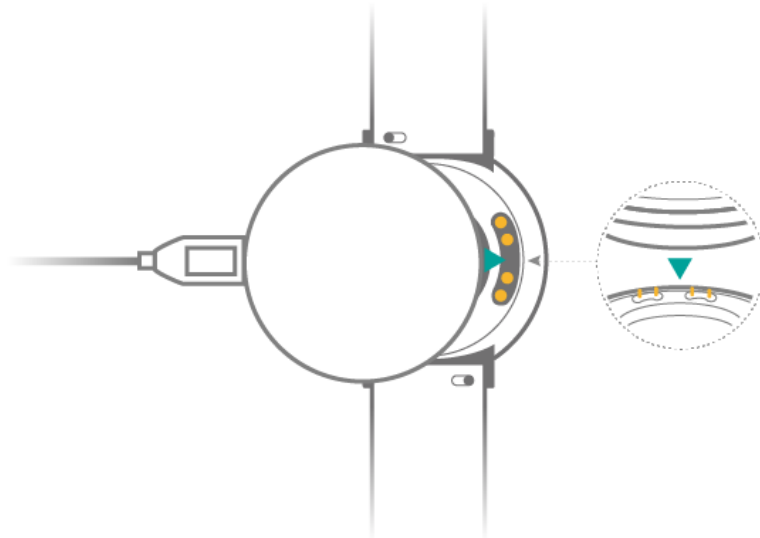

3. It takes approximately 2 hours to fully charge your watch. When your watch is fully charged, **100%** will be displayed on the watch screen. Disconnect your watch from the power adapter once it is fully charged.



 **NOTE**

- Charge your watch in a dry and well-ventilated environment.
- Wipe the charging port dry before charging to prevent stains or water on the metal contacts from causing short circuits or other risks.
- To protect the battery, the charging current will be reduced if the temperature is low, prolonging the charging time without affecting the battery lifespan.

Viewing the battery level

Use one of the following four methods to view the battery level.

Method 1: When your watch is connected to the power adapter for charging, the battery percentage will be displayed on the charging screen. Touch or swipe the screen to return to the home screen.

Method 2: Touch the watch face to view the battery level.

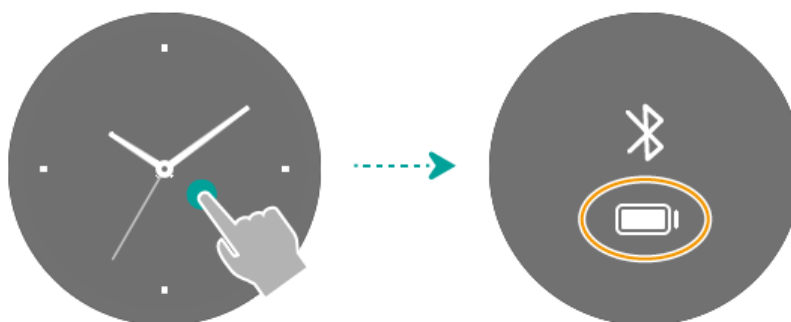

Method 3: The battery level is displayed on some pre-installed watch faces.

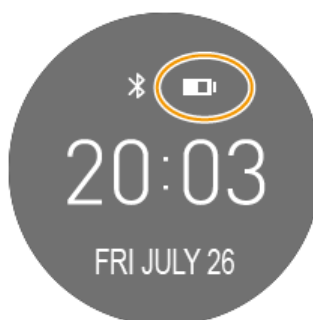

Method 4: When your watch is paired with your phone, open the app and touch **Devices**



to view the battery level.

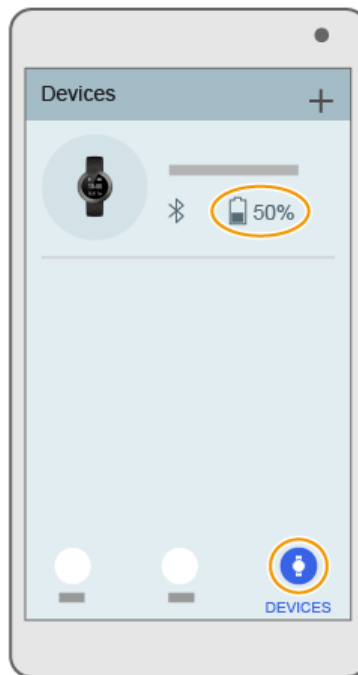

1.5 Pairing your watch with your phone

You can use your watch after pairing it with your phone. Perform the following steps to set it up.

1. Download the Huawei Wear app using either of the following methods:

Method 1: When you pair your watch and phone for the first time, swipe left on the watch's home screen to display the QR code. Use your phone to scan this QR code to download and install the Huawei Wear app.



Method 2: Search for Huawei Wear in the Google Play Store or Apple App Store to download and install the Huawei Wear app.

2. Turn on Bluetooth on your phone.
3. Open the app, touch **Agree**. Follow the onscreen instructions to log in with your Huawei ID and set your personal information (such as height and weight), and then touch **NEXT** to enter the home screen of the app.



NOTE

Fill out your personal information to let your watch provide more accurate exercise suggestions.

4. Touch **Devices**  >  to select your phone and then touch the Bluetooth name of your phone.



NOTE

If your phone runs Android™ 6.0 or later, turn on GPS on your phone when pairing.

5. When a pairing request appears on your watch screen, touch  to pair your watch and phone.

 **NOTE**

- Make sure your phone runs Android™ 4.4 or later or iOS 8.0 or later.
- Do not directly search for and connect to your watch on your phone's Bluetooth screen.
- To ensure that your watch and phone are paired properly, set the Huawei Wear app to keep running in the background when the screen is locked.

1.6 Power on/off and restart

Power on

Your watch automatically powers on when it is connected to the charger.

Power off

You cannot manually power off your watch. Your watch automatically powers off when it runs out of battery.

Restart

Use either of the following methods to restart your watch.

Method 1: Swipe up and down on your watch screen, touch **More**  , and select

Restart > .

Method 2: When your watch is connected to the power adapter, use your phone's eject pin to press and hold the restart button at the bottom of the charging cradle for 10s.

 **NOTE**

Do not use steel pins or objects that are too sharp to prevent damage to the restart button.

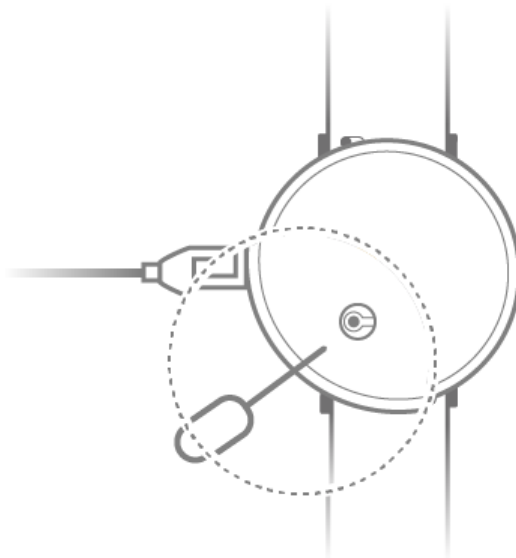

1.7 Gestures

You can operate your watch by touching and swiping the screen.

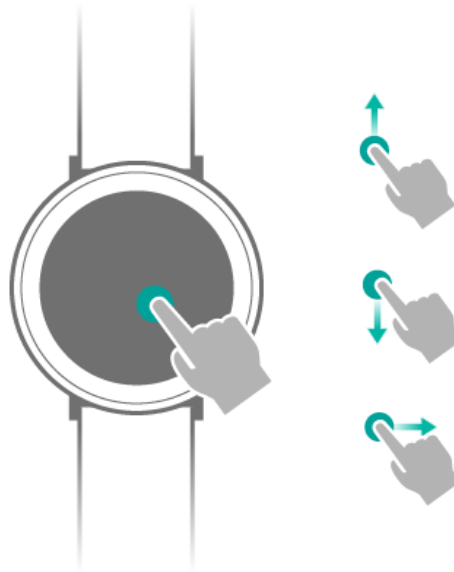

Gesture	Description
Touch	Select and confirm.
Swipe up	Access the shortcuts menu.
Swipe down	Access the shortcuts menu.
Swipe right	Go back to the previous menu or home screen.



NOTE

Swipe from the edge across the central part of the screen.

1.8 Screen operations

Turning on the screen (backlight on)

When the screen backlight is set to automatic or on, use either of the following methods to turn on the screen:

- Touch the screen to turn it on.
- Open the Huawei Wear app, touch **Devices** , select your device, and turn on **Rotate to Wake Screen**. Then, you can raise or rotate your wrist inward to turn on the screen.



NOTE

When the screen backlight is set to automatic, whether your watch screen turns on depends on your operation and gesture, as well as the ambient light. If the ambient light is very bright, your watch screen will not turn on.

Turning off the screen (backlight off)

When the screen backlight is set to automatic or on, you can lower or rotate your wrist outward to turn off the screen. The screen automatically turns off if there is no operation for a specified period.



Switching between screens

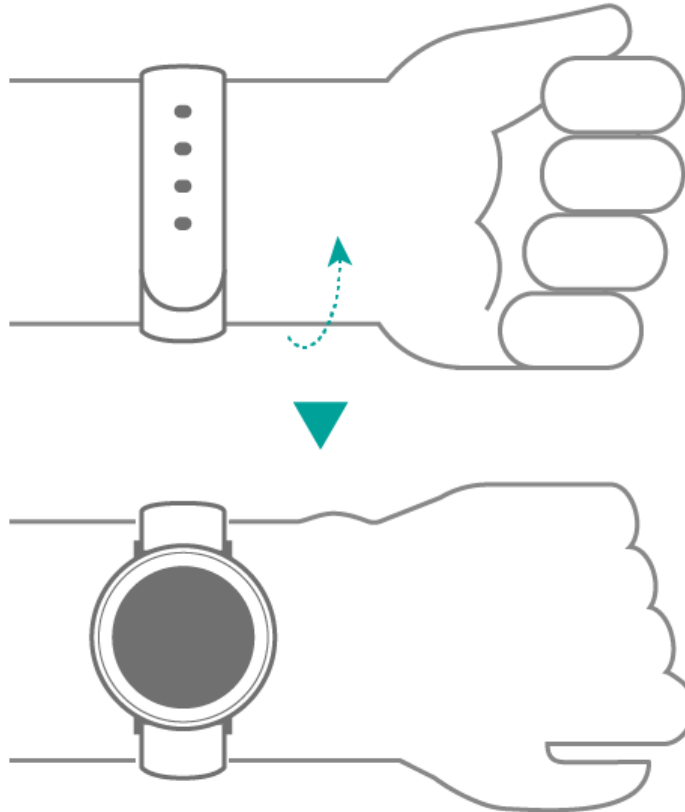













Rotate your wrist or swipe up or down the screen to switch between screens.





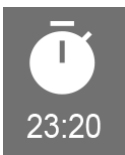
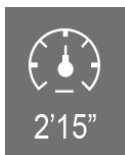







1.9 Icons

Your watch has the following icons.

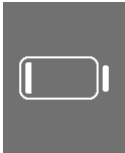
Walk 	Run 
Cycle	Treadmill

	
Swim 	Workout 
Training plan 	Sleep time 
Steps 	Calories 
Distance 	Heart rate range 
Exercise duration  23:20	Pace  2'15"
Incoming call  Cathy	Missed call  Cathy
Call ended 	Message  5
Bluetooth disconnected	Mute

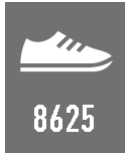
	
Alarm  10:30 pm	Snooze  10min
Turn off alarm 	Activity reminder 
Low battery alert 	Goal achieved  10000
Accelerate 	Retain 
Decelerate 	Data of the day  8625

2 Fitness and health

- 2.1 Recording and sharing your fitness data
- 2.2 Monitoring your heart rate
- 2.3 Starting a single exercise session
- 2.4 Starting your running training
- 2.5 Monitoring your sleep

2.1 Recording and sharing your fitness data

Recording your fitness data



Wear your watch and it will automatically record your fitness data all day.

Your watch can automatically record your steps, calories burned, and exercise distance, as well as track your progress of achieving your goals. When a goal is achieved, your watch will vibrate and display an achievement screen.

Use either of the following methods to view your fitness data:

Method 1: Swipe up or down your watch screen and find the  icon to view your steps and progress of the day. Touch the screen to view your steps, exercise distance, calories burned, and amount of sleep of the day.



Method 2: When your watch is paired with your phone, your watch data will be synced to the Huawei Wear app. Open Huawei Wear on your phone, and touch **Home**  to view your overall fitness, heart rate, and sleep data. You can also touch **Discover**  > **Fitness data**  to view your data in more detail.

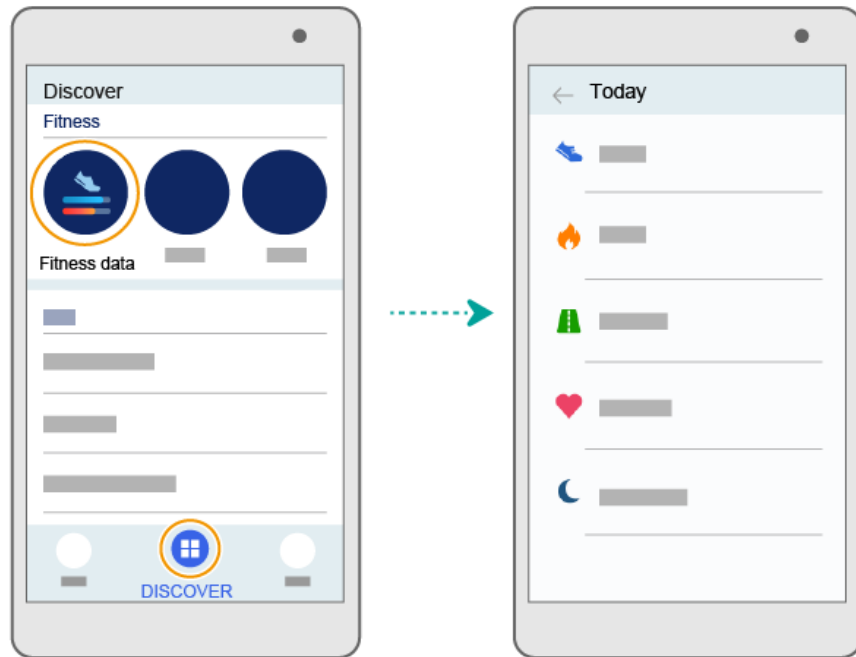

 **NOTE**

The preceding screenshots are applicable to Android™ phones and for your reference only. The actual screens may differ between phones.

Sharing your fitness data

Open the app, touch **Discover**  > **Third party services**, you can share your fitness data to the third party application.

 **NOTE**

Download and install the third party application. Your data will be shared to the app after logging in and authorizing.

2.2 Monitoring your heart rate

2.2.1 Testing your heart rate

Testing your heart rate

Wear your watch to monitor your heart rate using one of the following methods.

Method 1: Swipe up or down on the screen to enter the **Heart rate**  screen. Your watch will automatically measure your heart rate.

 **NOTE**

- After you enter the **Heart rate** screen, wait for about 2 seconds, and the screen will display **Measuring...** Wait for another 10 seconds, and the screen will display your heart rate. Your watch will keep testing and updating your heart rate within 45 seconds.
- To ensure higher heart rate accuracy, wear your watch properly and do not move.

Method 2: Swipe up or down on your watch screen and select **More**  > **Auto Measure**. Touch the screen to set the status to **ON**, and your watch will test your heart rate regularly.

Method 3: When you are on an exercise or training plan, your watch will automatically test your heart rate continuously.

 **NOTE**

- The heart rate accuracy is affected by physical factors, wearing positions, and movements. To increase data accuracy, wear your watch correctly.
- The heart rate result cannot be used for medical purposes.

Hear rate warning

Open the Huawei Wear app, touch **Devices** , select your device, touch **Heart rate limit interval and warning**, and turn on **Heart rate limit warning**. If your heart rate exceeds the set limit when you are working out, your watch will notify you.

 **NOTE**

- Touch **Heart rate limit** on the **Heart rate limit interval and warning** screen to set a heart rate limit.

Viewing previous heart rates

Use one of the following methods to view your previous heart rates:

Method 1: Swipe up or down on your watch screen to enter the **Heart rate**  screen. Touch the screen to view the curve of your heart rate changes in the past 4 hours.

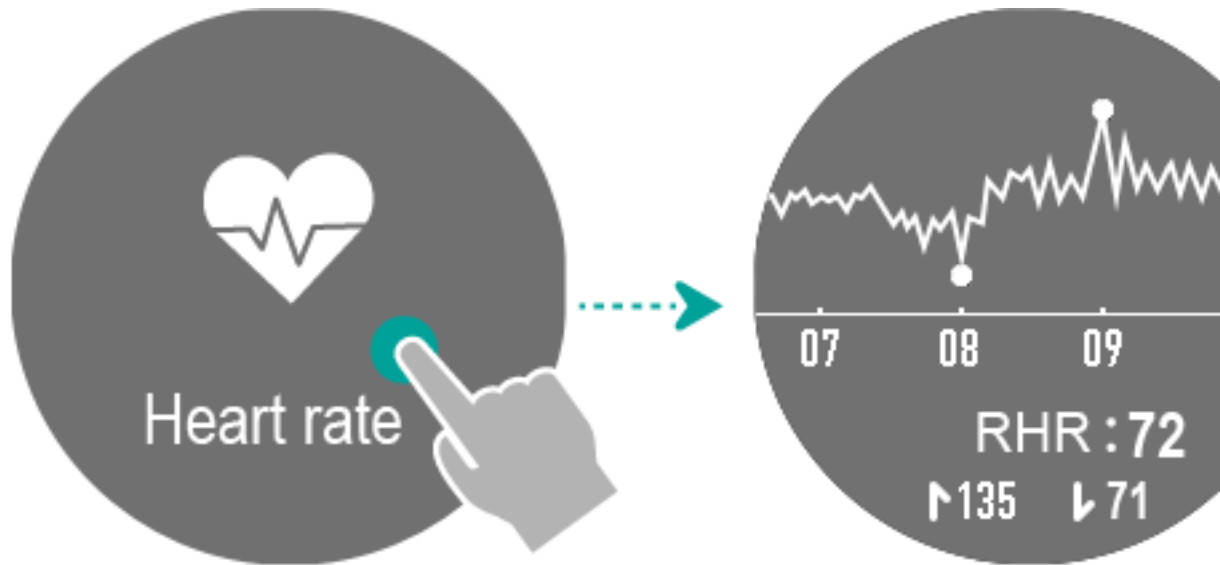

Method 2: Open the Huawei Wear app on your phone, touch **Home** , and swipe up to the heart rate section to view your resting heart rate of the day. Touch the heart rate section to view your heart rate data in detail.

Method 3: Open the app, and touch **Discover**  > **Fitness data**  > **Heart rate** to view your heart rate data in detail.

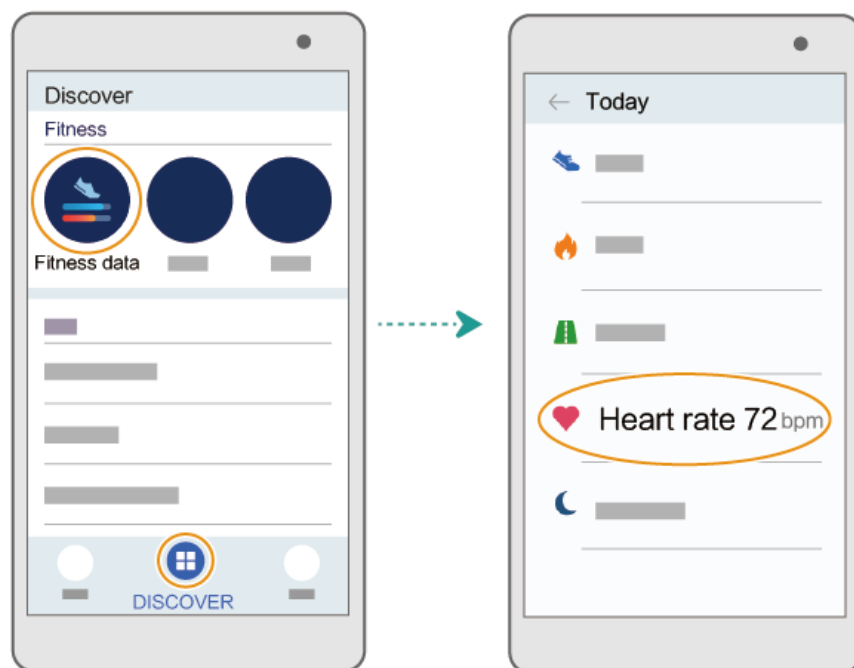



2.2.2 Broadcasting your heart rate

Pair your watch with a third-party app that supports connections to heart rate monitoring devices and enable heart rate broadcast on your watch to obtain your heart rate data from your watch.

 **NOTE**

- Before using the heart rate broadcast function, close the Huawei Wear app or disconnect it from your watch. This allows a third-party fitness app to search for your watch.
- Broadcasting your heart rate data from your watch is power-intensive.

1. Swipe up or down on your watch screen and touch **More**  > **Heart rate broadcast**.

2. Touch the screen to read the onscreen instructions, and then touch  or swipe right on the screen to turn on heart rate broadcast.

 **NOTE**

The onscreen instructions are only displayed the first five times you use heart rate broadcast. After you have used heart rate broadcast more than five times, it will be turned on directly once you touch **Heart rate broadcast**.

3. Touch  >  to turn off heart rate broadcast.

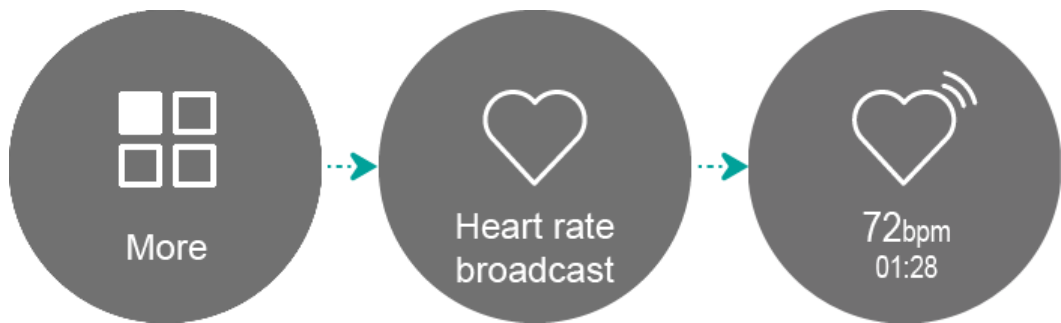

2.2.3 Using the heart rate limit interval

Heart rate limit intervals are an effective way to measure exercise intensity. Keeping your heart rate within the appropriate limit interval while exercising can increase your cardiopulmonary capabilities and improve your exercise results. Understanding your heart rate limit interval can prevent you from over-exercising and injury.

A heart rate limit interval refers to the heart rate range per minute, which is calculated based on the percentage of the maximum heart rate.

- If you know your maximum heart rate, open the Huawei Wear app, touch **Devices** , select your device, and then touch **Heart rate limit interval and warning** > **Maximum** to set your maximum heart rate.
- If you don't know your maximum heart rate, search for calculation methods online to calculate it. You can have your maximum heart rate calculated in some gyms or health centers. The preset maximum heart rate on your watch is 220 minus your age.

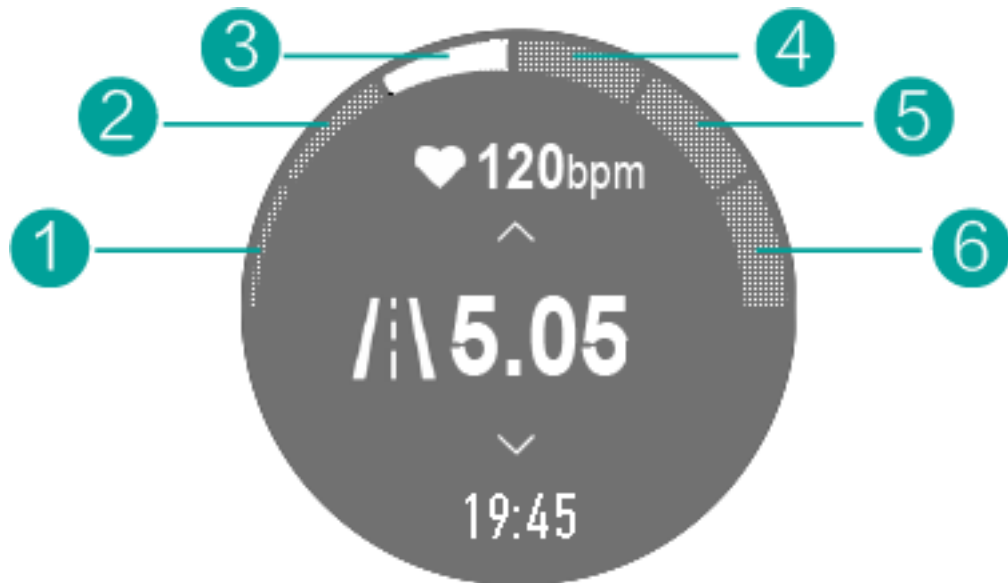

Table 2-1 Heart rate limit intervals

No.	Heart rate limit interval
1	-
2	Warm-up: This builds up your strength or warms up your body before exercise. Exercise type: walking fast
3	Fat burning: This improves your body strength, increases the fat burning speed of your body, and improves your cardiovascular adjustment. Exercise type: walking slowly
4	Aerobic endurance: This is for endurance training and improves your aerobic fitness, vital capacity, and breath control. Exercise type: easy running
5	Anaerobic endurance: This is for speed improvement training and improves your fitness. You need to control your exercise time at this interval. Exercise types: tempo running and running at intervals
6	Limit: This is for explosive power training, during which time lactic acid is accumulated fast with a high possibility of injury. You should strictly control your exercise time at this interval. Exercise type: running as long and fast as you can



2.3 Starting a single exercise session

2.3.1 Starting an exercise on the watch

Your watch provides you with multiple exercise types. Wear your watch and start exercising.

 **NOTE**

Start exercise from either your watch or the Huawei Wear app. Do not start simultaneously on both your watch and app.

1. Swipe up or down to enter the **Workout**  screen. Touch the screen to enter the exercise type screen.
 - Select **Run** and set your goal.
 - If you select **No goals**, you don't need to set a goal.
 - Select **Fat loss** or **Cardio**, read the onscreen instructions, and touch .
 - Select **Distance**, **Time**, or **Calories** and set your goal.

Then, after a countdown from 3 to 1, you can start your exercise.



NOTE



Walk, **Cycle**, and **Treadmill** do not support setting goals.

- If you select **Swimming**, double-touch the screen when you are stable to start or stop swimming.



NOTE

- When you enter the exercise screen again after you have started your exercise on your watch, **Quick start** mode will appear. You can touch it to quickly start your previous exercise again.
- If you select running, walking, or cycling, it is recommended that you keep your watch connected to your phone and turn on GPS to obtain accurate fitness data.

2. During an exercise, swipe right on your watch screen and touch  to pause your exercise,  to continue your exercise, and  to end your exercise.



NOTE

If your exercise lasts less than 1 minute, your watch will not record it.

During your exercise, you can swipe up or down on your watch screen to view your fitness data in real time. Your watch will monitor your fitness and health in real time and provide reminders, for example, reminding you to accelerate or decelerate (only applicable to scenarios where the running goal is set to cardiopulmonary training or fat loss), or notifying you that your heart rate is too high. Check for such reminders and make adjustments accordingly.

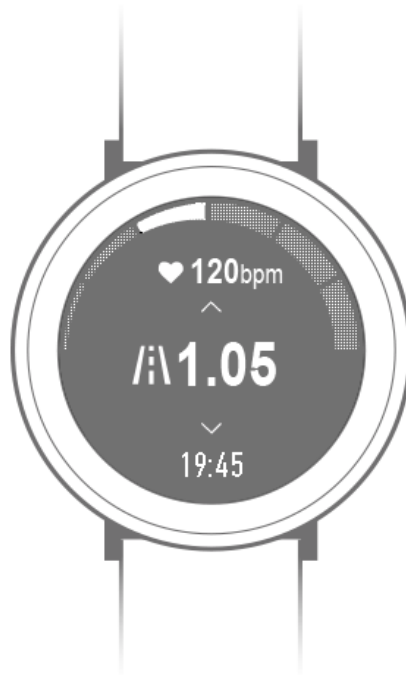

2.3.2 Viewing exercise results on the watch

When you have finished exercising, swipe on your watch screen to view your exercise result.

 **NOTE**

- The result items vary by exercise type.



The training effect is calculated based on your personal settings, heart rate, exercise duration, and exercise intensity. You can use the score to check your exercise intensity and fitness improvement.

Score	Exercise Effect
1.0–1.9	Lack of exercise
2.0–2.9	Fitness maintained
3.0–3.9	Fitness improved
4.0–4.9	Fitness significantly improved
5.0	Over-exercise

The new record is the best achievement of your exercise history, and will only appear if your current training effect is better than the previous best result.

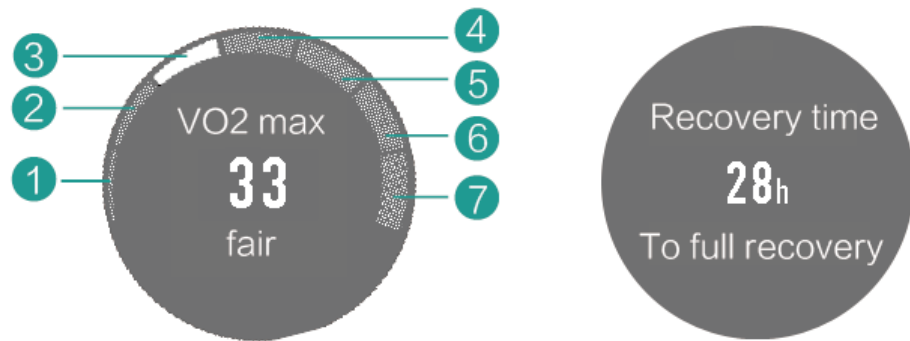

VO2max refers to the amount of oxygen that you breathe in when you cannot continue during an exercise of the maximum intensity. VO2max is an important indicator to measure a person's aerobic endurance and fitness potential. Your VO2max increases as your fitness improves.

The unit of VO2max is ml/kg/min, consisting of seven sections.

Section	Description
1	Very low
2	Low
3	Acceptable
4	Average
5	Good
6	Very good
7	Excellent

The recovery time refers to the duration estimated by your watch from your current exercise to the next when your body has completely recovered.



NOTE

The VO2max and recovery time are only displayed in your running results.

2.3.3 Starting an exercise in the Huawei Wear app

When your watch is paired with your phone, you can use the app to calculate your fitness data of a single exercise session. Wear your watch and start exercising.





NOTE

Start exercise from either your watch or the Huawei Wear app. Do not start simultaneously on both your watch and app.

Use either of the following methods to start an exercise session in the app.

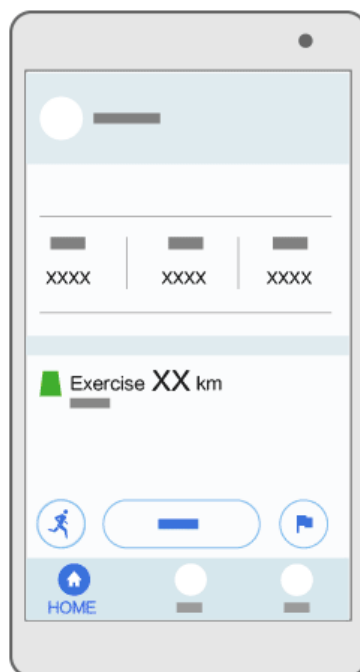

Method 1: (using running as an example)

1. Turn on GPS on your phone.
2. Open the app, touch **Home** . Touch  in the exercise section, and select **Running**.
3. Touch  to set a goal.
4. Touch **Start running**. After a countdown from 3 to 1, you can start your exercise.







Method 2:

1. Turn on GPS on your phone.

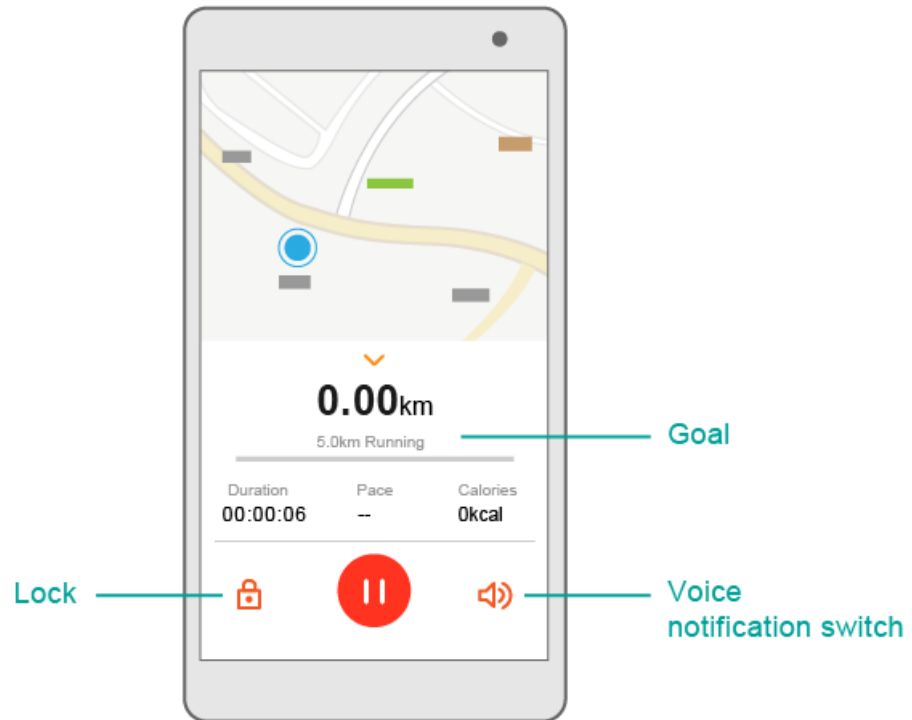
2. Open the app, touch **Discover**  > **Workout** .
3. Select an exercise type and set a goal.
4. Touch **Start**. After a countdown from 3 to 1, you can start your exercise.

During your exercise, you can view your fitness data and movement track in the app in real time.



- Touch  to pause your exercise.
- Touch  to continue your exercise.
- Touch  to end your exercise.

2.3.4 Viewing exercise results in the Huawei Wear app

After you have finished your exercise, you can view your exercise result in the app.

1. Open the app, touch **Home** , and then touch the exercise section to view your exercise history.

2. Touch an exercise record to view its result.

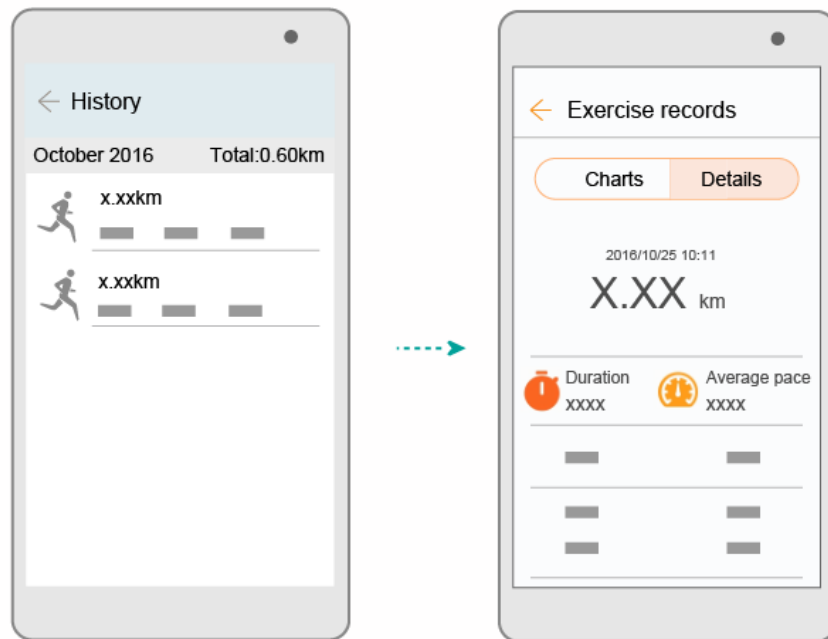



2.4 Starting your running training

2.4.1 Creating a training plan

Your watch works as your fitness instructor, and can arrange your running plans based on your personal conditions and the training goals you have set. Your watch can also analyze your fitness data and provide you with scientific running suggestions to improve your running capability and achieve your training goal.

Before you start running, perform the following steps to create a training plan in the app.

1. Open the app, touch **Discover**  > **Training plan**  or **Home** , swipe up on the screen to enter the training section, and then touch **ADD PLAN**.
2. Set your running distance goal and touch **NEXT**.

 **NOTE**

If you are preparing for a running event, touch **Training for an event?**, turn on **Training for an event**, and set the event date.

3. Set the best result within the target distance and the expected result after the training, and touch **NEXT**.

 **NOTE**

You can also touch **SKIP** to skip the best result within the target distance and the expected result after the training, and directly proceed to step 4.

4. Set the number of running times per week.

 **NOTE**

Touch **Do you want to schedule a rest day?** to set your rest days when you don't feel like running.

5. Touch **CREATE** to create your own running plan.



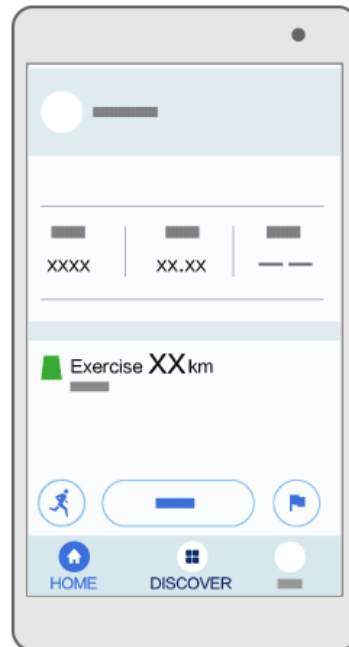

NOTE

You can create a training plan from 4 to 24 weeks in the app.



After creating your training plan, touch **Discover**  > **Training plan**  > **VIEW** in the app to view and manage your training tasks.

- Touch  > **Exercise reminders**, turn on **Exercise reminders**, and set your exercise reminder time.
- Touch  > **Edit plan name** to edit your plan name.
- Touch  > **End plan** > **END** to end your plan.

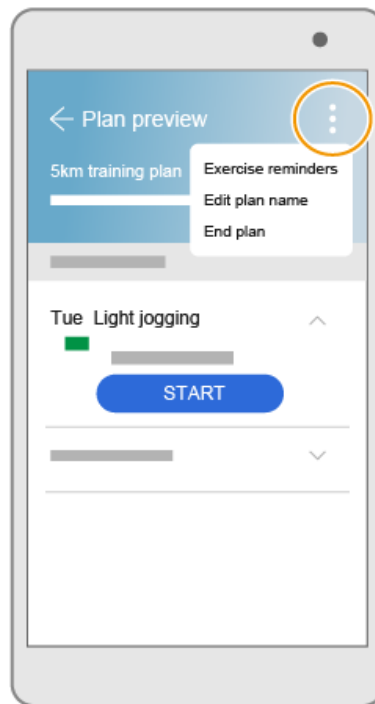





2.4.2 Starting training

After you have created your training plan, it will be automatically synced to your watch. When you start a training session you can start your exercise in the Huawei Wear app or on your watch.

NOTE

- Start running from either your watch or the app. Do not start simultaneously on both your watch and app.
- To obtain a better exercise experience, it is recommended that you run outdoors.

Starting a workout on the watch

1. Swipe up or down on your watch screen to enter the **Training plan** . Touch the screen to view your training sessions Touch . After a countdown from 3 to 1, you can start running.
2. During your exercise, swipe right on your watch screen, and then touch  to pause running. Touch  to continue running. Touch  to finish running.

When you are running, you can swipe up or down on your watch screen to view your fitness data in real time. Your watch monitors your fitness and health in real time, and will remind you to accelerate or decelerate, or notify you that your heart rate is too high. Pay attention to your watch's reminders and make adjustments accordingly.

Starting a workout in the app

Turn on GPS on your phone. Use either of the following methods to start a workout in the app.

Method 1: Open the app, touch **Home** , swipe up to enter the training section, and touch **Start running** to start training.

Method 2: Open the app, and touch **Discover**  > **Training plan**  > **VIEW** > **START**.

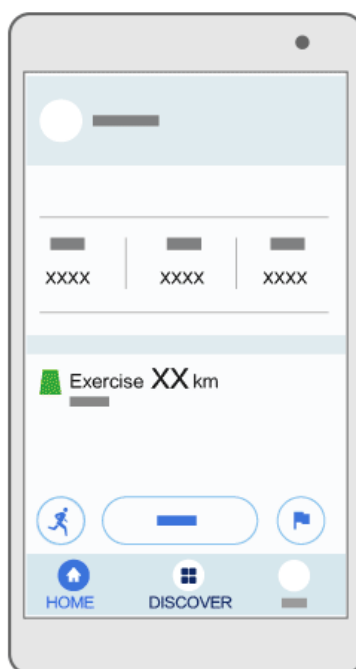

2.4.3 Viewing training results



Viewing training results on your watch

After you have finished your running training, you can view your training result on your watch.

Viewing training results in the app

After you have finished your running training, use either of the following methods to view your training progress in the Huawei Wear app.

Method 1:

1. Open the app, touch **Home** , and then touch the training section. Alternatively, touch **Discover**  > **Training plan** .
2. Touch **Training history** to view your training history.

3. Touch a training record to view its result. Touch  to view your training report.

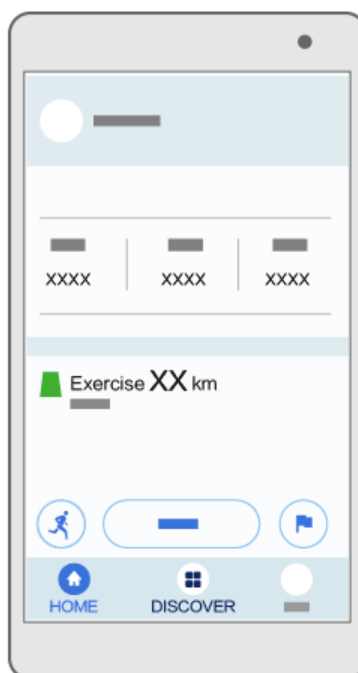

Method 2:

1. Open the app, touch **Home** , and then touch the exercise section to view your exercise history.
2. Touch an exercise record to view its result.

2.5 Monitoring your sleep

Your watch can automatically record your amount of sleep, identify whether you are awake, in light sleep, or in deep sleep, and smartly evaluate your sleep quality.

To increase your sleep quality, open the Huawei Wear app, touch **Device** , select your device, and touch **Do Not Disturb** to set do not disturb mode.

- Turn on **Do not disturb** to set your watch to do not disturb mode.
- Turn on **Scheduled** to set the start and end times of a do not disturb period. Your watch is in do not disturb mode during the do not disturb period.

NOTE

When your watch is in do not disturb mode, it will not notify you of any incoming calls or messages. Your watch screen will not turn on when you rotate your wrist.

3 Messaging assistant

- 3.1 Message alerts
- 3.2 Rejecting or muting incoming calls
- 3.3 Alarms

3.1 Message alerts

Enabling message alerts

1. Open the Huawei Wear app, touch **Devices** , select your device, and touch **Message alerts**.
2. Turn on the **Message alerts** switch and allow the app to read notifications.
3. Turn on the switches for the applications that will send you notifications.



NOTE

If you are using an iPhone, you only need to turn on the **Message alerts** switch.

Viewing new messages

When you are wearing your watch, it will vibrate if it receives new messages. You can view new messages on your watch, and swipe up on the screen or rotate your wrist to view more message details.



 **NOTE**

- If your watch detects that you are sleeping or you have set do not disturb mode in the app, your watch will not vibrate when receiving new messages.
- When you are not wearing your watch and your phone receives new messages, your watch will not vibrate nor display new messages. Those new messages will be directly stored in the message center.

Viewing unread messages

Swipe up or down to enter the  screen, and then touch it to enter the message list to view unread messages.

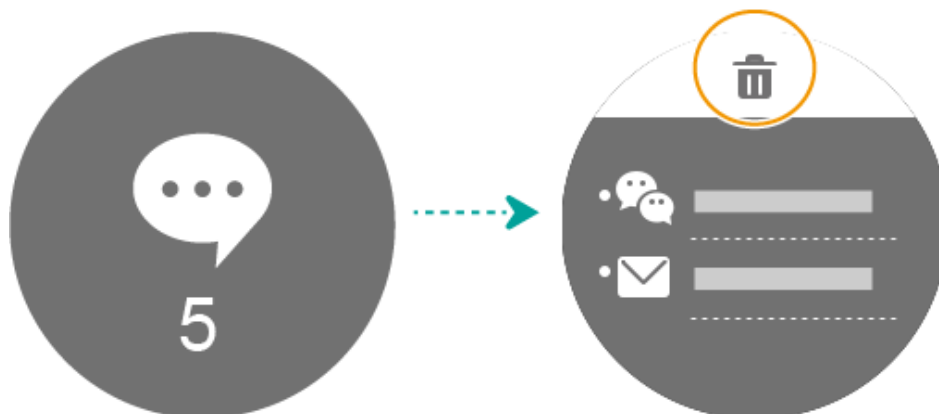



 **NOTE**

- The number displayed in the message center indicates the number of unread messages.
- Your watch can store up to 12 messages.
- If your watch detects that you are sleeping or you have set do not disturb mode in the app, your watch will not vibrate when receiving new messages.

Deleting messages

Swipe up or down to enter the  screen, and then touch it to enter the message list to view unread messages.

- Touch  to delete all messages.

- Touch a message, and then touch  to delete it.

 **NOTE**

- Viewing or deleting messages on your watch does not affect the messages on your phone. You can still view them on your phone.
- If your phone runs iOS 8.0 or later, messages on your watch will also be deleted if you have read or deleted them on your phone.

3.2 Rejecting or muting incoming calls

When you are wearing your watch and a call comes in, your watch will vibrate. You can reject or mute the call.

 **NOTE**

- If you have set do not disturb mode in the Huawei Wear app, your watch will not vibrate for incoming calls.
- When you are not wearing your watch, your watch will not vibrate for incoming calls.

Rejecting incoming calls

Swipe up on your watch screen to reject an incoming call.



Muting incoming calls

Touch your watch screen to mute an incoming call.



 **NOTE**

- Muting incoming calls is only supported by Apple phones running iOS 8.0 or later.
- If your phone runs Android™ 4.4 or later, you can touch your watch screen to stop your watch from vibrating.

3.3 Alarms



Set an alarm in the Huawei Wear app and wear your watch. Your watch will vibrate when the alarm goes off.

 **NOTE**

If you are not wearing your watch when the alarm goes off, your watch will not vibrate.

Alarms

Open the Huawei Wear app, touch **Devices** , select your device, and then touch **Alarm settings** to select and set an alarm.

- **Smart alarm:** Turn on the smart alarm switch, set the alarm time, smart wakeup time, and repeat cycle, and then touch .
- **Event alarm:** Touch **Add alarm**, set the alarm time, label, and repeat cycle, and then touch .

 **NOTE**

You can set up to one smart alarm and five event alarms.

Turning off an alarm

When an alarm goes off, swipe up on your watch screen to turn it off.



Snoozing an alarm

When an alarm goes off, touch the screen or do nothing, and your watch will snooze for 10 minutes before vibrating again.



4 Settings

- 4.1 Changing personal information
- 4.2 Changing the watch face
- 4.3 Setting the backlight
- 4.4 Restoring factory settings
- 4.5 Updating your watch and app
- 4.6 Obtaining the watch information

4.1 Changing personal information

Open the Huawei Wear app, touch **Home** , touch your profile picture, and change your personal information in **User information**.

 **NOTE**

To make sure your watch provides you with accurate fitness suggestions, it is recommended that you update your personal information.

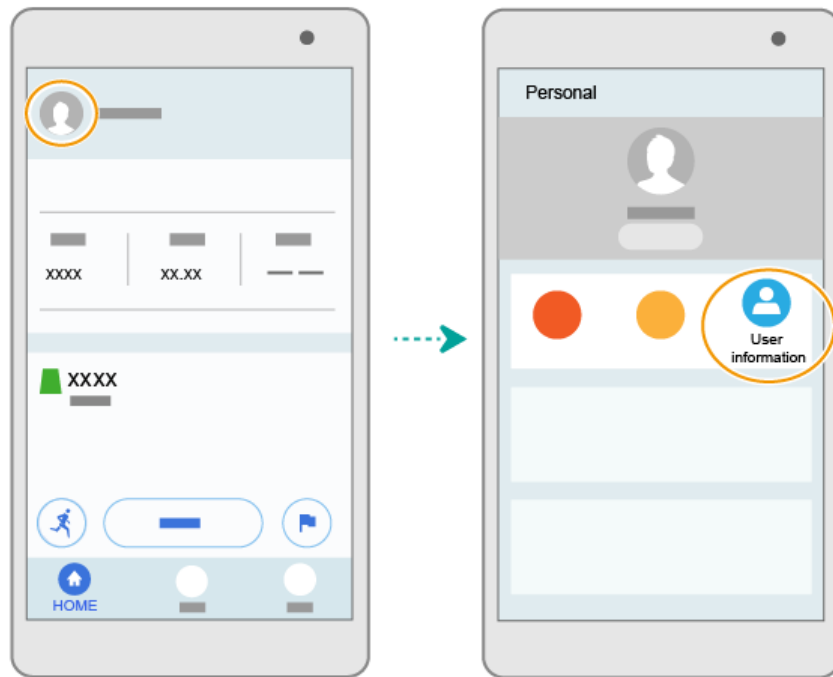

4.2 Changing the watch face

Your watch has many watch faces for you to choose from.

1. Swipe up or down on your watch screen and select **More**  > **Watch face**.
2. Swipe up or down on your watch screen to switch between watch faces, and touch a watch face to select it.

4.3 Setting the backlight

Set the backlight to adjust your screen brightness.

Swipe up or down on your watch screen. Select **More**  > **Backlight** and touch the screen to set backlight mode.

Table 4-1 Backlight mode

Backlight mode	Description
Auto	Your watch automatically turns the screen on or off based on the ambient light, as well as your gestures and operations.
On	Your watch automatically turns the screen on or off based on your gestures and operations.

Backlight mode	Description
Off	Your watch screen is turned off all the time.



NOTE

Your watch is in automatic backlight mode by default.

4.4 Restoring factory settings



NOTE

After factory settings are restored on your watch, all the data on your watch, including the pairing information, will be deleted, and you will need to pair your watch with your phone again.

Use either of the following methods to restore factory settings on your watch.

Method 1: Swipe up or down on your watch screen, and select **More**  > **Reset** > .

Method 2: Open the Huawei Wear app, touch **Devices** , select your device, touch **Restore factory settings**, and then touch **OK**.

4.5 Updating your watch and app

To improve your user experience, please update your watch and app when possible.

Updating your watch

Updating on your watch: If a new version is available, your watch will send a notification to you. Follow the onscreen instructions to update your watch.



NOTE

You can perform an update on your watch only when it has more than 20% battery power.

Updating in the app: Open the app, touch **Devices** , select your device, and touch **Firmware update** > **Check for updates**. Your watch will automatically check for updates and perform one if available.

Updating the app

iOS users: Update the app from the App Store.

Android users:

1. Open the app, touch **Home** , and touch your profile picture.
2. Touch **About** > **App update**. If your phone displays **Updating...**, the app is being updated.

4.6 Obtaining the watch information

Learn about your watch.

Swipe up or down on your watch screen, touch **More**  > **About** to view your watch information, such as the watch name, software version, and regulatory information.

5 Product maintenance

- 5.1 Saving battery life
- 5.2 Changing the watch strap
- 5.3 Water and dust resistance
- 5.4 Cleaning your watch
- 5.5 Caring for your watch

5.1 Saving battery life

Your watch battery life depends on the battery capacity and usage. If you use watch features intensively, this will reduce the standby time.

You can use the following methods to extend the standby time.

Method 1: Open the Huawei Wear app, touch **Devices** , select your device, touch **Message alerts**, and turn off applications that do not require notifications.

Method 2: Power consumption is high when your watch and phone frequently disconnect and re-connect. When you do not need your phone, disconnect it from your watch.

Method 3: Power consumption is high when your watch backlight feature is on. Set your watch to automatic backlight mode.

Method 4: Power consumption is high when your watch is set to automatically test your heart rate. Turn this feature off when you do not need it.

5.2 Changing the watch strap

To change your watch strap, push the button on your strap, lift the strap and remove it, and then release the button.

Perform the preceding operation in the reverse sequence to install a new strap.

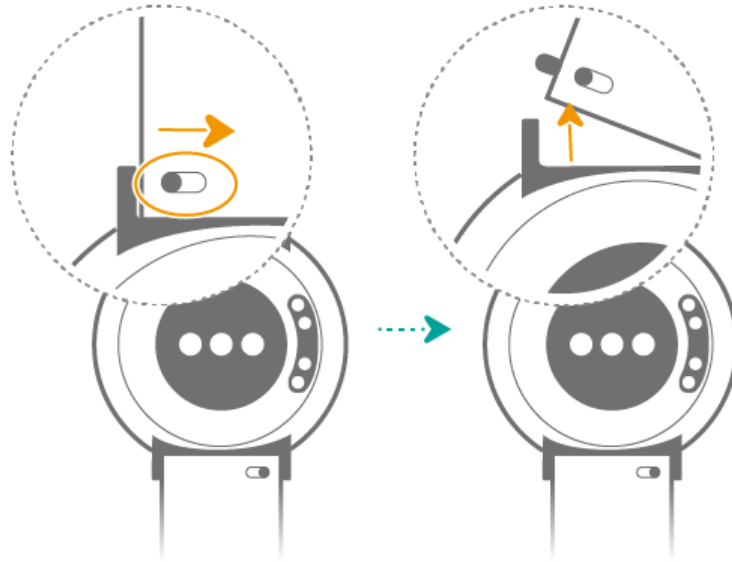

5.3 Water and dust resistance

Your watch has an IP68 water and dust resistance rating and supports 5ATM water resistance. You can wear and use your watch when swimming in a pool, washing your hands, showering with cold water, washing your car, or when it is raining.



However, do not use your watch when swimming in the sea, showering with hot water, scuba diving, underwater diving, or when you are in a hot spring or a sauna.





NOTE

Your watch's water and dust resistance may be affected if it has been dropped to the ground or subjected to other serious impact.

5.4 Cleaning your watch

Keep your watch and strap clean and dry to extend your watch's lifespan. You can use a tissue or soft cloth dipped in alcohol to wipe the surface of your watch. Note the following when cleaning your watch:

- Disconnect your watch from the power adapter before cleaning.
- Wipe off your sweat from your watch and strap after you exercise.
- Do not put your watch into liquid other than fresh water at room temperature.
- To prevent corrosion and damage to your watch, do not use chemical product or cleanser to clean your watch or its accessories.
- After cleaning your watch, use a dry cloth or tissue to wipe your watch dry, preventing remaining water from condensing inside your watch, and thus damaging your watch.

It is recommended that you use a cotton swab, cotton cloth or brush dipped in alcohol to wipe the charging port of your watch on a regular basis, to remove dirt from the charging port.

5.5 Caring for your watch

Caring for your strap

- Do not use strong chemical products or cleansers to clean your watch or its accessories. Use a clean and dry soft cloth to wipe your watch and its accessories.
- If your watch has a light color strap, keep it away from clothes with dark colors.

Caring for your watch

- Keep your watch and its accessories dry. Do not dry them using a microwave oven or hair drier.
- Do not keep your watch and its accessories in areas with extreme temperatures. Otherwise, your watch may malfunction, burn, or even explode.
- Keep your watch and its accessories from strong impact or shaking, to prevent damage and malfunction.