

**LINKSYS®**

User Guide

**MAX-STREAM™  
AC2200 MU-MIMO  
TRI-BAND ROUTER**

Model EA8300

# Contents

<b>Product Overview</b> .....	<b>3</b>
Top view .....	3
System status indicator.....	4
Back view.....	5
Side view.....	6
<b>Setting Up: Basics</b> .....	<b>7</b>
Where to find more help .....	7
How to install your router .....	8
<b>How to Use Linksys Smart Wi-Fi</b> .....	<b>11</b>
How to connect to Linksys Smart Wi-Fi.....	11
Network Map.....	12
Guest Access .....	12
Parental Controls.....	13
Media Prioritization.....	13
Speed Test.....	14
External Storage.....	14
Connectivity .....	15
Troubleshooting.....	15
Wireless.....	16
Security.....	16
<b>Troubleshooting</b> .....	<b>17</b>
Your router was not successfully set up.....	17
<i>Your Internet cable is not plugged in</i> message.....	18
<i>Cannot access your router</i> message.....	19
After setup.....	21
The internet appears to be unavailable .....	21
Linksys Smart Wi-Fi does not open in your web browser.....	22
<b>Specifications</b> .....	<b>23</b>
Linksys EA8300 .....	23
Environmental.....	23

# Product Overview

## Top view

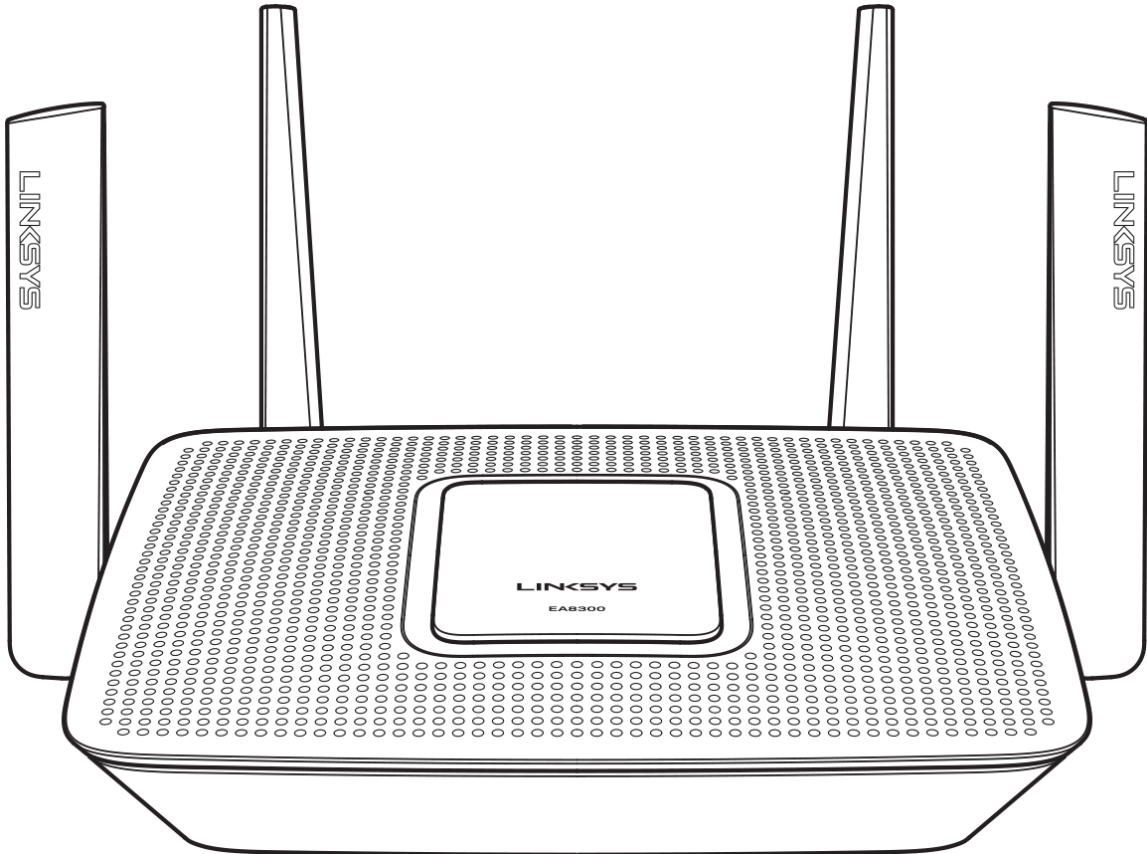

## System status indicator

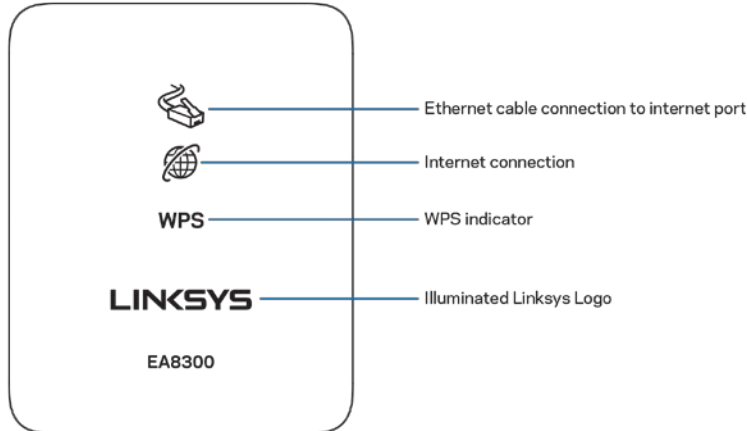

**Ethernet cable connection to Internet port**—When lit (orange), indicates a problem with the network cable connected to the Internet (WAN) port.

**Internet connection**—When lit (orange), indicates the router cannot access the internet.

**WPS (Wi-Fi Protected Setup™) indicator**—The WPS light has four states:

<b>Off</b>	No Wi-Fi Protected Setup activity
<b>Blinking White</b>	Wi-Fi Protected Setup in progress
<b>Solid White</b>	Wi-Fi Protected Setup is successful; remains lit for five seconds
<b>Blinking Orange</b>	Wi-Fi Protected Setup error; blinks for one minute, then goes off

**Illuminated Linksys Logo**—Logo blinks while the router is starting up. When the logo is solid white, the router is powered on and working correctly.

## Back view

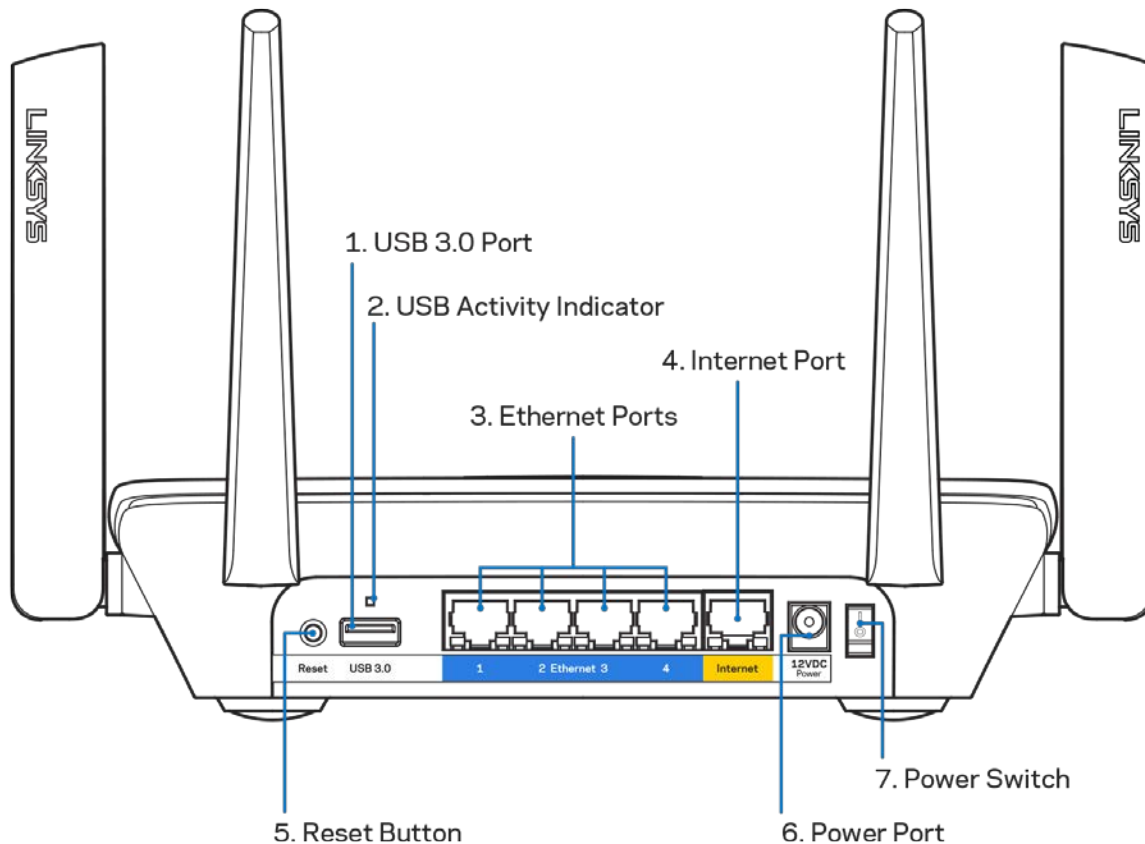

**USB 3.0 port (1)**— Connect and share USB drives on your network or on the internet.

**USB activity indicator (2)**— Lights indicate data transfer to/from external devices.

**Ethernet ports (3)**—Connect ethernet cables to these blue gigabit (10/100/1000) ports, and to wired devices on your network.

**Note**—*For best performance, use CAT5e or higher rated cables on the Ethernet ports.*

**Internet port (4)**— Connect an ethernet cable to this yellow gigabit (10/100/1000) port, and to a broadband internet cable/DSL or fiber modem.

**Note**—*For best performance, use CAT5e or higher rated cable on the Internet port.*

**Reset button (5)**— Press and hold until the illuminated Linksys logo turns off to reset the router to factory settings. You can also restore the factory settings using Linksys Smart Wi-Fi on the internet or mobile app.

**Power port (6)**—Connect the included AC power adapter.

**Power switch (7)**—Press | (on) to turn on the router.

# Side view

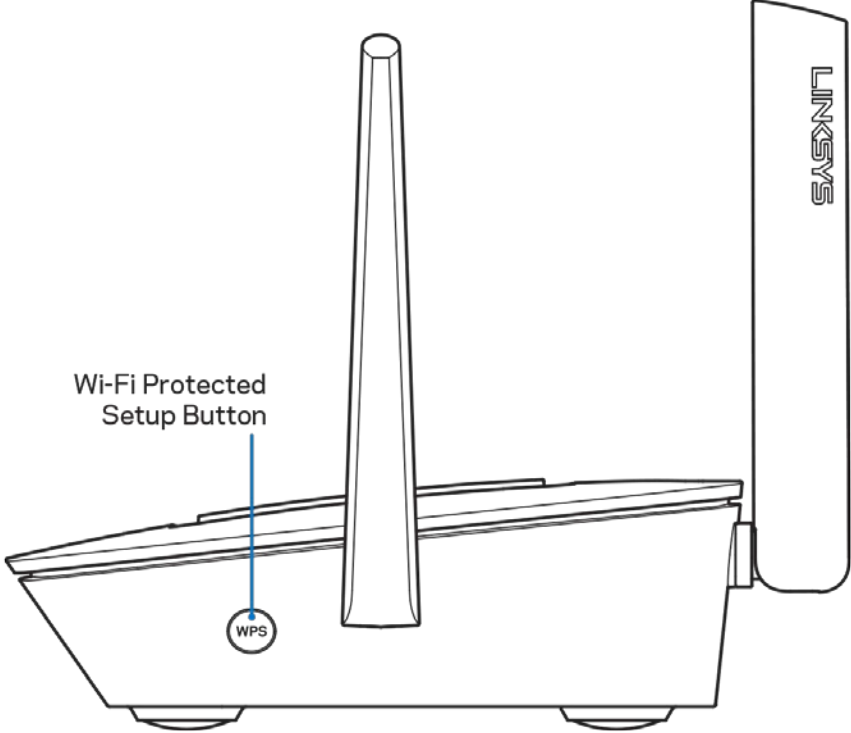

**Wi-Fi Protected Setup™ button**—Press to connect to WPS-enabled network devices.

# Setting Up: Basics

## Where to find more help

In addition to this user guide, you can find help at these locations:

- [Linksys.com/support/EA8300](http://Linksys.com/support/EA8300) (documentation, downloads, FAQs, technical support, live chat, forums)
- Linksys Smart Wi-Fi help (connect to Linksys Smart Wi-Fi, then click Help at the top of the screen)

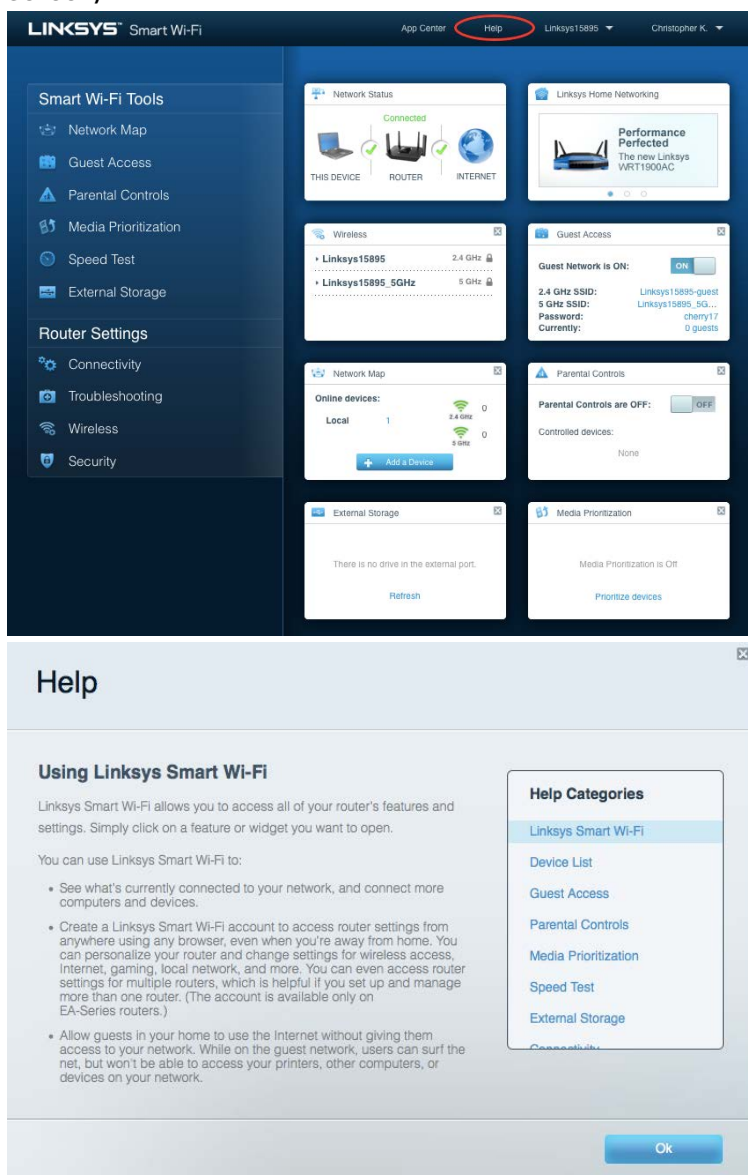

**Note**—Licenses and notices for third party software used in this product may be viewed on <http://support.linksys.com/en-us/license>. Please contact <http://support.linksys.com/en-us/gplcodecenter> for questions or GPL source code requests.

## How to install your router

1. To complete setup, you will need a computer to visit <http://LinksysSmartWiFi.com> in a web browser.
2. Identify your equipment.

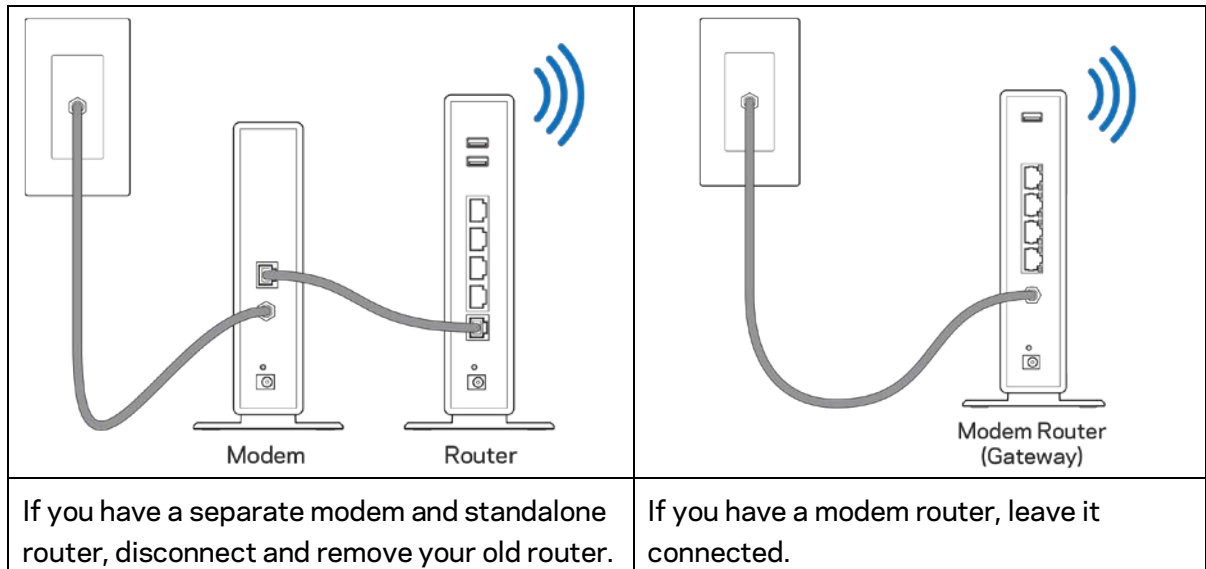

3. Position the antennas straight up and plug in the router to a power source. Make sure the power switch is in the | (on) position.
4. Connect your router to your modem or modem router. Plug one end of the included internet cable to the yellow Internet port on your new router. If you have a modem, plug the other end into the Ethernet (LAN) port on the modem. If you have a modem router, plug into any available port.
5. Wait until the illuminated Linksys light on the top of your router stops blinking and is solid white.
6. Connect to the Wi-Fi name shown in the Quick Start Guide that came with your router. (You can change these details later.) If you need help connecting to the network refer to your device documentation at [linksys.com/support/EA8300](http://linksys.com/support/EA8300).

**Note**—You will not have internet access until router setup is complete.

7. Enter <http://LinksysSmartWiFi.com> in a web browser. Follow the on-screen instructions to complete your router setup. You also can type 192.168.1.1 in a browser to start setup.



At the end of setup, follow the on-screen instructions to set up your Linksys Smart Wi-Fi account. Use Linksys Smart Wi-Fi to configure your router from any computer with an internet connection.

Manage your router's settings:

- Change your router's name and password
- Set up guest access
- Configure parental controls
- Connect devices to your Wi-Fi
- Test your internet connection speed

**Note**—As part of Linksys Smart Wi-Fi account setup, you will be sent a verification e-mail. From your home network, click the link in the email to associate your router with the Linksys Smart Wi-Fi account.

**Tip**—Print the next page, then record your router and account settings in the table as a reference. Store your notes in a safe place.

2.4 GHz Wi-Fi Name	
Wi-Fi Password	
5 GHz <sub>1</sub> Wi-Fi Name	
Wi-Fi Password	
5 GHz <sub>2</sub> Wi-Fi Name	
Wi-Fi Password	
Router Password	
2.4 GHz Guest Wi-Fi Name	
5GHz Guest Wi-Fi Name	
Guest Wi-Fi Password (Both share a password.)	
Linksys Smart Wi-Fi Username	
Linksys Smart Wi-Fi Password	

# How to Use Linksys Smart Wi-Fi

You can manage your router from anywhere in the world by using Linksys Smart Wi-Fi, but you can also do it directly from your home network. Linksys Smart Wi-Fi may be available for your mobile device, as well. See your device's app store for information.

## How to connect to Linksys Smart Wi-Fi

To connect to Linksys Smart Wi-Fi:

1. Open your computer's web browser.
2. Go to <http://LinksysSmartWiFi.com> and log in to your account.

If you can't remember your password, click *Forgot your password?* and follow the on-screen instructions to recover it.

# Network Map

Lets you display and manage all network devices connected to your router. You can view devices on your main network and your guest network, or display information about each device.



# Guest Access

Lets you set up and monitor a network for guests to access Wi-Fi without exposing personal information.

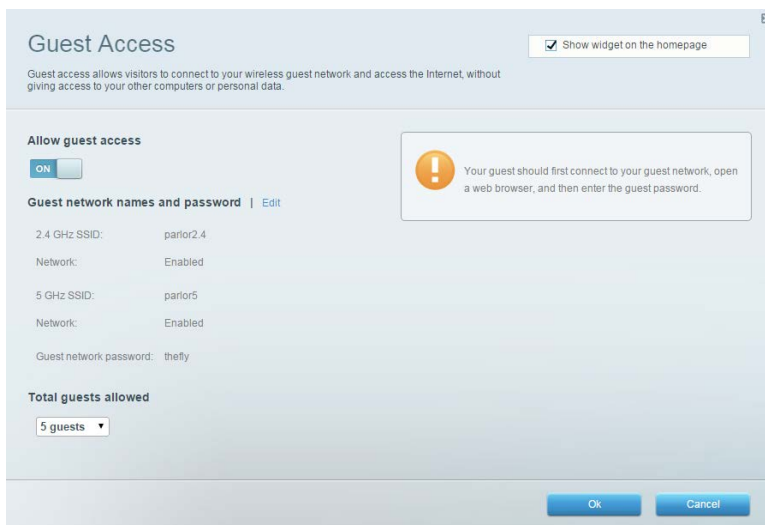

# Parental Controls

Lets you block web sites and set internet access times.

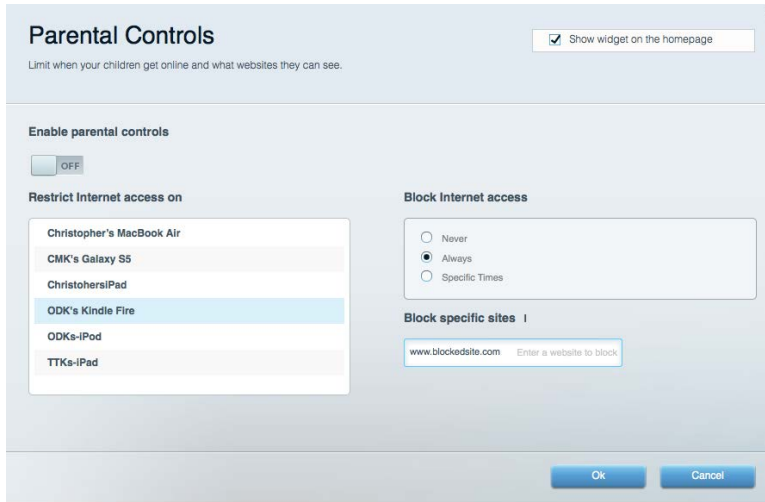

# Media Prioritization

Lets you set which devices and applications have top priority for your network traffic.

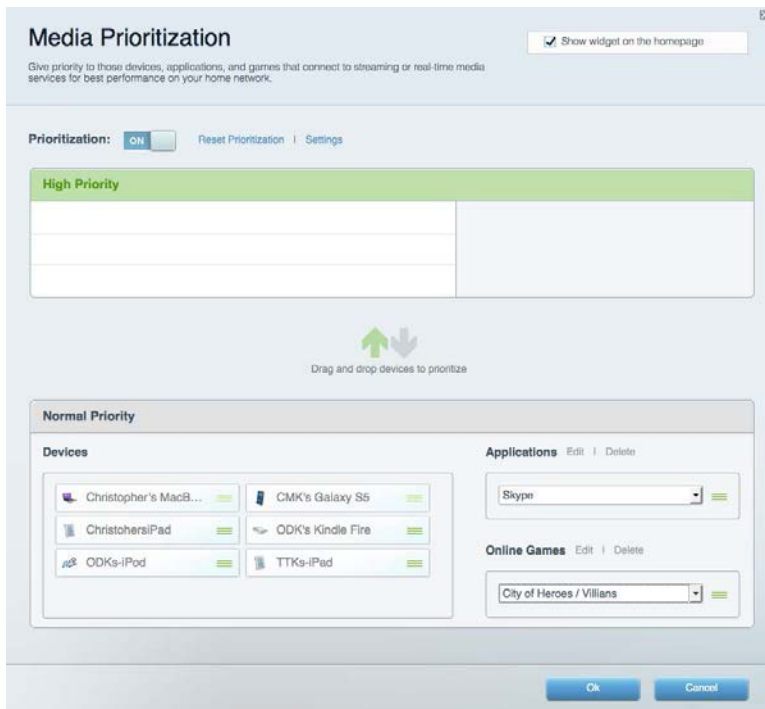

## Speed Test

Lets you test your network's internet connection speed.



## External Storage

Lets you access an attached USB drive (not included) and set up file sharing, a media server, and FTP access.

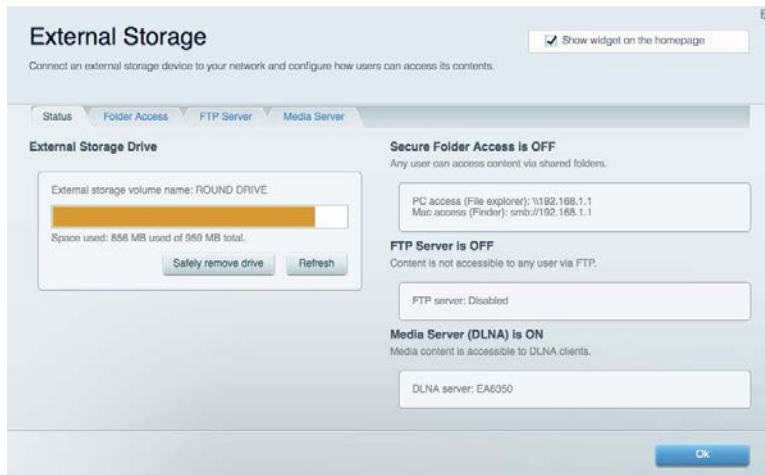

# Connectivity

Lets you view and change basic and advanced network settings.

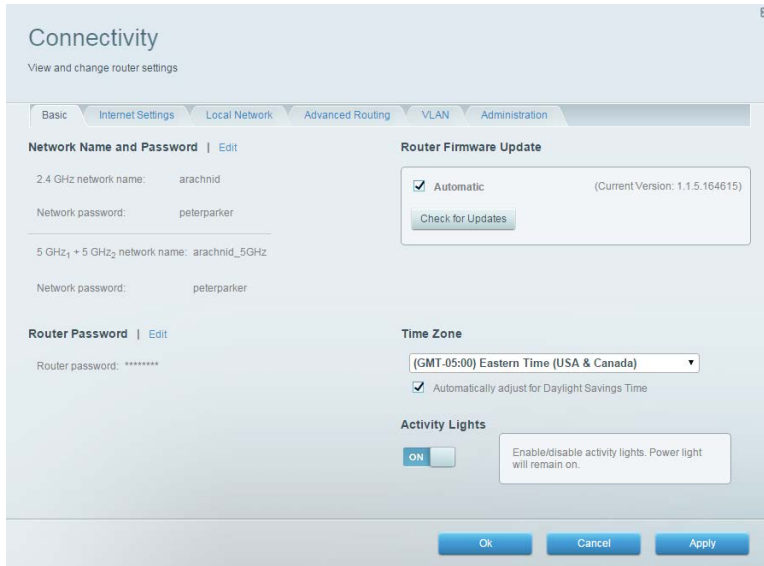

# Troubleshooting

Lets you diagnose problems with your router and check the status of the network.

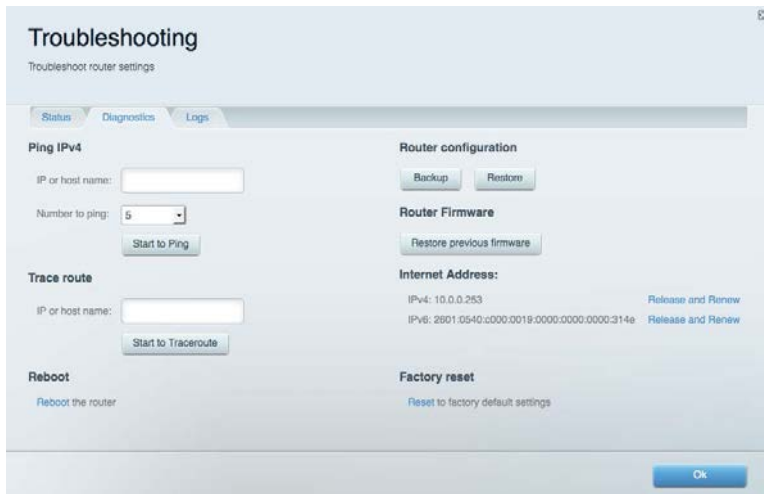

## Wireless

Lets you view and change your router's wireless network. You can change network names, security mode, password, MAC filtering, and connect devices using Wi-Fi Protected Setup.

The screenshot shows the 'Wireless' settings page. At the top, there is a 'Show widget on the homepage' checkbox which is checked. Below this, there are tabs for 'Wireless', 'MAC Filtering', and 'Wi-Fi Protected Setup'. The 'Smart Connect' section has two radio buttons: '5 GHz band steering' (selected) and 'Off'. Below this, there are two network configuration sections. The first is for the 2.4 GHz network, with a name of 'arachnid', password 'peterparker', and security mode 'WPA2/WPA Mixed Pt'. The second is for the 5 GHz network, with a name of 'arachnid\_5GHz', password 'peterparker', and security mode 'WPA2/WPA Mixed Pt'. At the bottom, there are 'Ok', 'Cancel', and 'Apply' buttons.

## Security

Lets you view and change your router's wireless security. You can set up the firewall, VPN settings, and make custom settings for applications and games.

The screenshot shows the 'Security' settings page. At the top, there are tabs for 'Firewall', 'DMZ', and 'Apps and Gaming'. The 'Firewall' section is active and contains several sub-sections: 'Firewall' with checkboxes for 'IPv4 SPI firewall protection' and 'IPv6 SPI firewall protection', both checked; 'VPN Passthrough' with checkboxes for 'IPSec Passthrough', 'PPTP Passthrough', and 'L2TP Passthrough', all checked; and 'Internet filters' with checkboxes for 'Filter anonymous Internet requests', 'Filter multicast', 'Filter Internet NAT redirection', and 'Filter ident (Port 113)'. Below these is an 'IPv6 Port Services' table with columns for 'Description', 'Protocol', 'IPv6 Address', 'Allow', and 'Enabled'. At the bottom, there are 'Ok', 'Cancel', and 'Apply' buttons.

Description	Protocol	IPv6 Address	Allow	Enabled



# Troubleshooting

You can find more help from our award-winning customer support at [linksys.com/support/EA8300](https://linksys.com/support/EA8300).

## Your router was not successfully set up

If Linksys Smart Wi-Fi did not complete the setup, you can try the following:

- Press and hold the Reset button on your router with a paperclip or pin until the illuminated Linksys logo turns off and the blue MU-MIMO indicators start blinking (about 10 seconds). Install the router again.

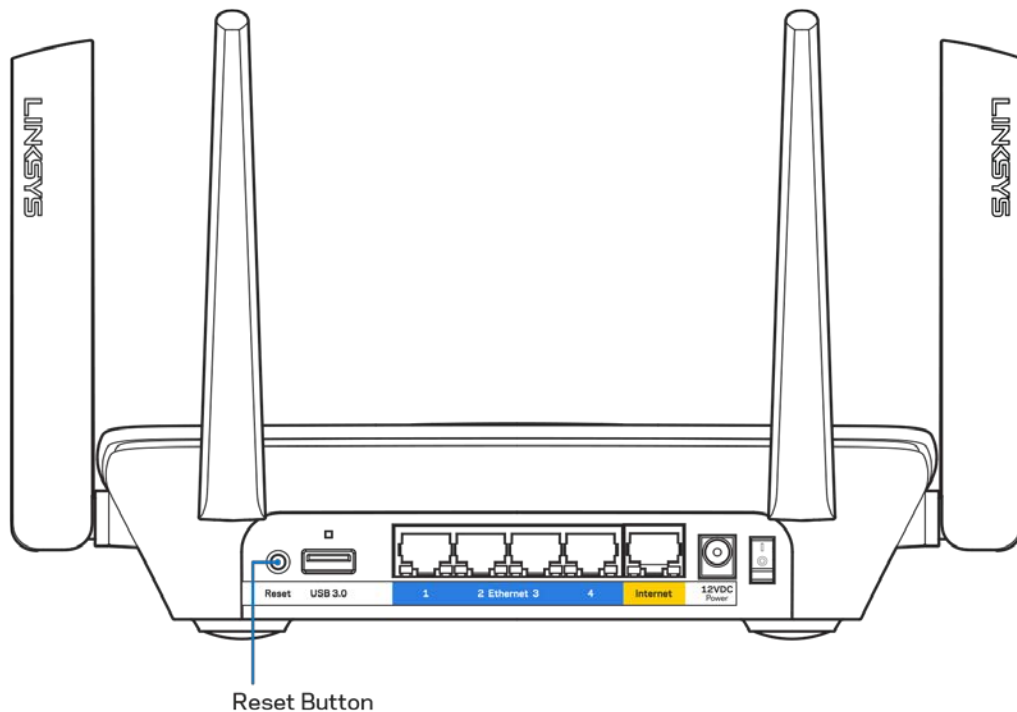

- Temporarily disable your computer's firewall (see the security software's instructions for help). Install the router again.
- If you have another computer, use that computer to install the router again.

## *Your Internet cable is not plugged in message*

If you get a “Your Internet cable is not plugged in” message when trying to set up your router, follow these troubleshooting steps.

- Make sure that an ethernet or internet cable (or a cable like the one supplied with your router) is securely connected to the yellow Internet port on the back of the router and to the appropriate port on your modem. This port on the modem is usually labeled Ethernet.

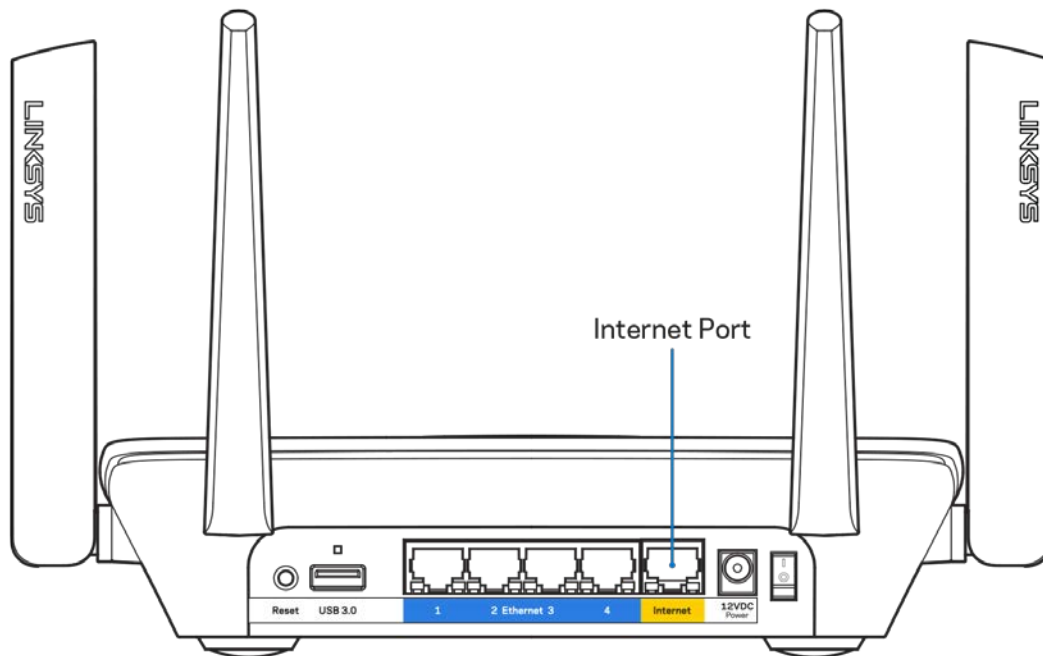

- Make sure that your modem is connected to power and is turned on. If it has a power switch, make sure that it is set to the ON or | (as opposed to O) position.

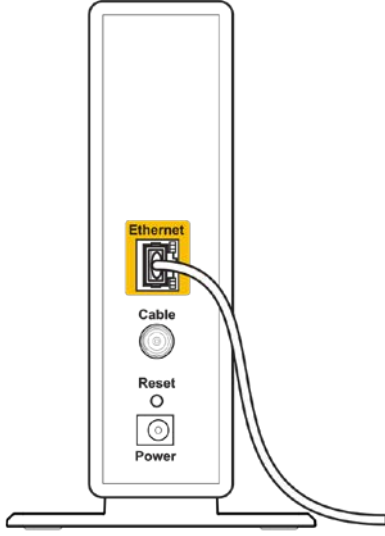
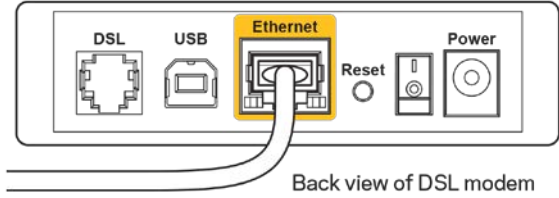
 <p>Back view of cable modem</p>	 <p>Back view of DSL modem</p>
<p>If your internet service is cable, verify that the cable modem's CABLE port is connected to the coaxial cable provided by your ISP.</p>	<p>If your internet service is DSL, make sure that the DSL phone line is connected to the modem's DSL port.</p>

- If your computer was previously connected to your modem with a USB cable, disconnect the USB cable.
- Install the router again.

## ***Cannot access your router message***

To access your router, you must be connected to your own network. If you have wireless internet access, the problem may be that you have accidentally connected to a different wireless network.

To fix the problem on Windows computers, do the following\*:

1. Click on the wireless icon in the system tray. A list of available networks will appear.

2. Click your own network name. Click Connect. In the example below, the computer was connected to another wireless network named wraith\_5GHz. The wireless network name of the Linksys EA8300 router, Damaged\_Beez2.4 in this example, is shown selected.



3. If you are prompted to enter a network security key, type your password (security key) into the network security key field. Click **OK**.
4. Your computer will connect to the network, and you should be able to access the router.

*\*Depending on your version of Windows, there could be some differences in wording or icons in these steps.*

To fix the problem on Mac computers, do the following:

1. In the menu bar across the top of the screen, click the Wi-Fi icon. A list of wireless networks will appear.
2. In the example below, the computer was connected to another wireless network named wraith\_5GHz. The wireless network name of the Linksys EA8300 router, Damaged\_Beez2.4 in this example, is shown selected.



3. Click the wireless network name of your Linksys EA8300 router (Damaged\_Beez2.4 in the example).
4. Type your wireless network password (Security Key) into the *Password* field. Click **OK**.

## After setup

### The internet appears to be unavailable

If the internet has difficulty communicating with your router, the problem may appear as a "Cannot find [internet address]" message in your web browser. If you know that the internet address is correct, and if you've tried several valid internet addresses with the same result, the message could mean that there's a problem with your ISP or modem communicating with your router. Try the following:

- Make sure that the network and power cables are securely connected.
- Make sure that the power outlet that your router is connected to has power.
- Reboot your router.
- Contact your ISP and ask about outages in your area.

The most common method of troubleshooting your router is to turn it off, then back on again. Your router can then reload its custom settings, and other devices (such as the modem) will be able to rediscover the router and communicate with it. This process is called rebooting.

To reboot your router using the power cord, do the following:

1. Disconnect the power cord from the router and the modem.
2. Wait 10 seconds, and reconnect the power cord to the modem. Make sure it has power.
3. Wait until the modem's online indicator has stopped blinking (about two minutes). Reconnect the power cord to the router.
4. Wait until the illuminated Linksys logo is on. Wait two minutes before trying to connect to the internet from a computer.

To reboot your router using Linksys Smart Wi-Fi, do the following:

1. Log in to Linksys Smart Wi-Fi. (See "How to connect to Linksys Smart Wi-Fi" on page [11](#).)
2. Under *Router Settings*, click *Troubleshooting*.
3. Click the *Diagnostics* tab.
4. Under *Reboot*, click Reboot.



5. Click **Yes**. The router will reboot. While the router is rebooting, all connected devices will lose their internet connection, and will automatically reconnect when the router is ready again.

## Linksys Smart Wi-Fi does not open in your web browser

The latest versions of Google Chrome™, Firefox®, Safari® (for Mac® and iPad®), Microsoft Edge, and Internet Explorer® version 8 and newer work with Linksys Smart Wi-Fi.

# Specifications

## Linksys EA8300

Model Name	Max-Stream AC2200 MU-MIMO Tri-Band Router
Model Number	EA8300
Switch Port Speed	10/100/1000 Mbps (Gigabit Ethernet)
Radio Frequency	2.4 GHz and 5 GHz (x2)
# of Antennas	4 external adjustable antennas (non-detachable)
Ports	USB 3.0, Ethernet (1-4), Internet, Power
Buttons	Wi-Fi Protected Setup, Power, Reset
Lights	<b>Top panel:</b> Illuminated Linksys logo , Wi-Fi Protected Setup, Internet connection, Network cable connection to internet port <b>Back panel:</b> USB, Ethernet (1-4), Internet
UPnP	Supported
Security Features	WEP, WPA2, RADIUS
Security Key Bits	Up to 128-bit encryption
Storage File System Support	FAT, NTFS, and HFS+
Browser Support	Latest versions of Google Chrome™, Firefox®, Safari® (for Mac® and iPad®), Microsoft Edge and Internet Explorer® version 8 and newer

## Environmental

Dimensions	213.7mm x 161.8mm x 54.8mm (without antennas)
Unit Weight	608 g
Power	12V, 2A
Certifications	FCC, IC, CE, Wi-Fi (a/b/g/n/ac)
Operating Temperature	32 to 104°F (0 to 40°C)
Storage Temperature	-4 to 140°F (-20 to 60°C)
Operating Humidity	10% to 80% relative humidity, non-condensing
Storage Humidity	5% to 90% non-condensing

Specifications are subject to change without notice.

Notes:

For regulatory, warranty, and safety information, see the CD that came with your router or go to [Linksys.com/support/EA8300](http://Linksys.com/support/EA8300).

Maximum performance derived from IEEE Standard 802.11 specifications. Actual performance can vary, including lower wireless network capacity, data throughput rate, range and coverage.

Performance depends on many factors, conditions and variables, including distance from the access point, volume of network traffic, building materials and construction, operating system used, mix of wireless products used, interference and other adverse conditions.

BELKIN, LINKSYS and many product names and logos are trademarks of the Belkin group of companies. Third-party trademarks mentioned are the property of their respective owners. Licenses and notices for third party software used in this product may be viewed here:

<http://support.linksys.com/en-us/license>. Please contact <http://support.linksys.com/en-us/gplcodecenter> for questions or GPL source code requests.

© 2017 Belkin International, Inc. and/or its affiliates. All rights reserved.

LNKPG-00459 Rev. A00



**LINKSYS®**

Guía del usuario

**ROUTER GIGABIT  
MU-MIMO TRIBANDA  
AC2200  
MAX-STREAM™**

Modelo EA8300

# Contenido

Descripción del producto .....	3
Vista de la parte superior .....	3
Indicador de estado del sistema .....	4
Vista de la parte trasera .....	5
Vista lateral .....	6
Instalación: Principios básicos .....	7
Dónde encontrar más ayuda.....	7
Cómo instalar el router .....	8
Cómo usar la Linksys Smart Wi-Fi .....	11
Cómo conectar a Linksys Smart Wi-Fi.....	11
Mapa de red .....	12
Acceso de usuarios invitados.....	12
Controles parentales.....	13
Priorización del contenido multimedia .....	13
Test de velocidad.....	14
Almacenamiento externo.....	14
Conectividad .....	15
Resolución de problemas.....	15
Red inalámbrica.....	16
Seguridad .....	16
Resolución de problemas .....	17
El router no se ha configurado correctamente .....	17
<i>Mensaje «El cable de internet no está conectado»</i> .....	18
<i>Mensaje «No se puede acceder al router»</i> .....	19
Tras la instalación.....	21
Parece que no hay conexión a internet disponible.....	21
Linksys Smart Wi-Fi no se abre en tu explorador web .....	22
Especificaciones .....	23
Linksys EA8300 .....	23
Datos físicos.....	23

# Descripción del producto

## Vista de la parte superior

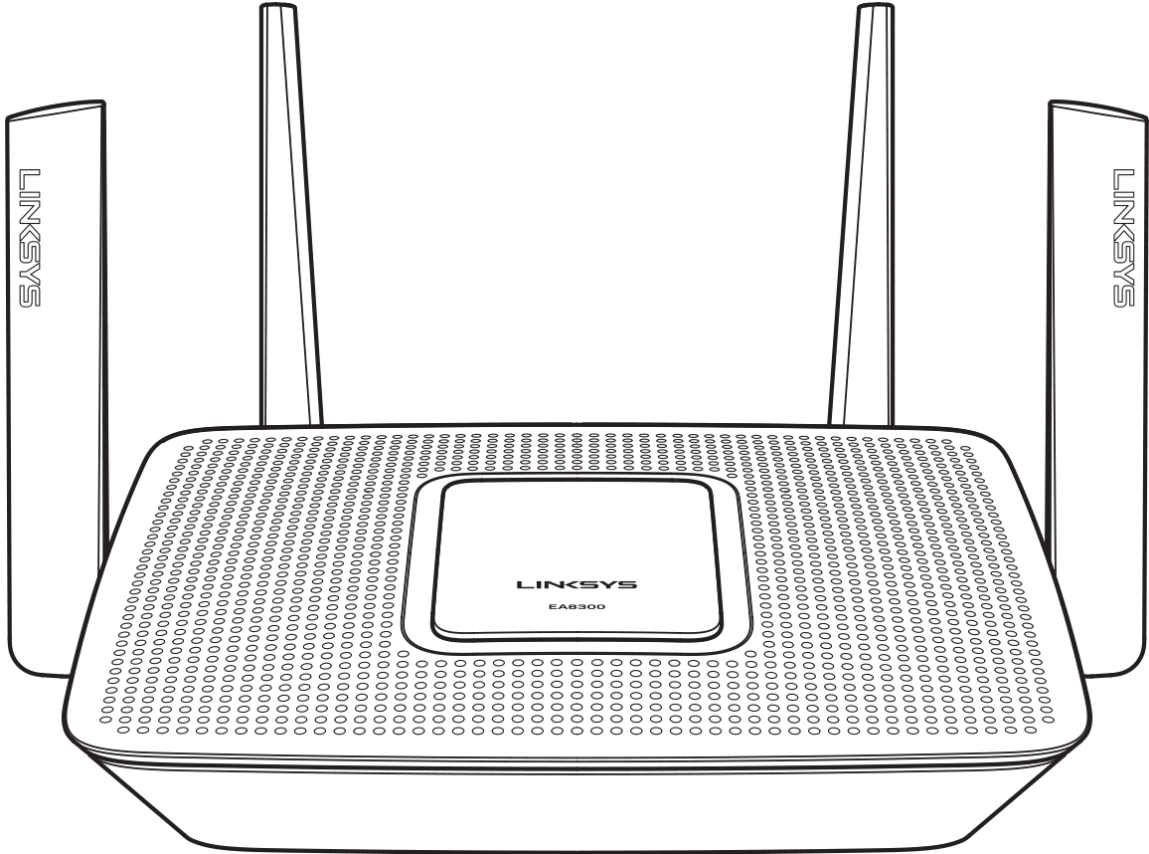

## Indicador de estado del sistema

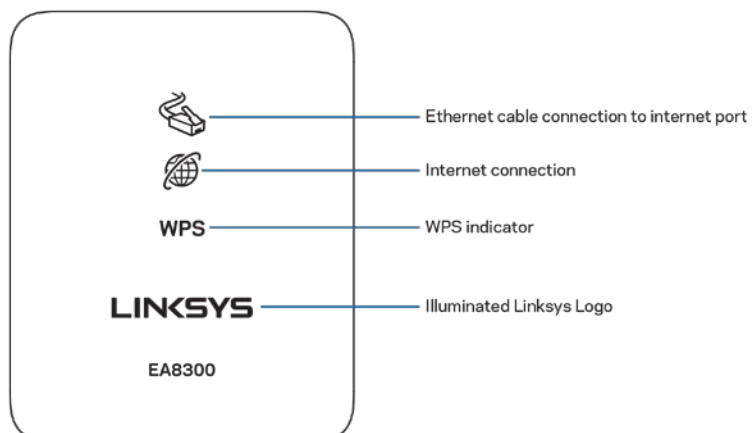

**Conexión del cable de red al puerto de internet:** si se enciende (en color naranja) indica que existe un problema con el cable de red conectado al puerto de internet (WAN).

**Conexión a internet:** si se enciende (en color naranja) indica que el router no se puede conectar a internet.

**Indicador de WPS (Wi-Fi Protected Setup™):** la luz de WPS tiene cuatro estados:

<b>Apagada</b>	Sin actividad de Wi-Fi Protected Setup
<b>Blanco intermitente</b>	Wi-Fi Protected Setup en curso
<b>Blanco fijo</b>	Wi-Fi Protected Setup se ha realizado por éxito; permanece encendida durante 5 segundos
<b>Naranja intermitente</b>	Error de Wi-Fi Protected Setup; parpadea durante un minuto y después se apaga

**Logotipo de Linksys iluminado:** parpadea mientras el router se está iniciando. Cuando el logotipo se enciende en blanco fijo el router está encendido y funciona correctamente.

## Vista de la parte trasera

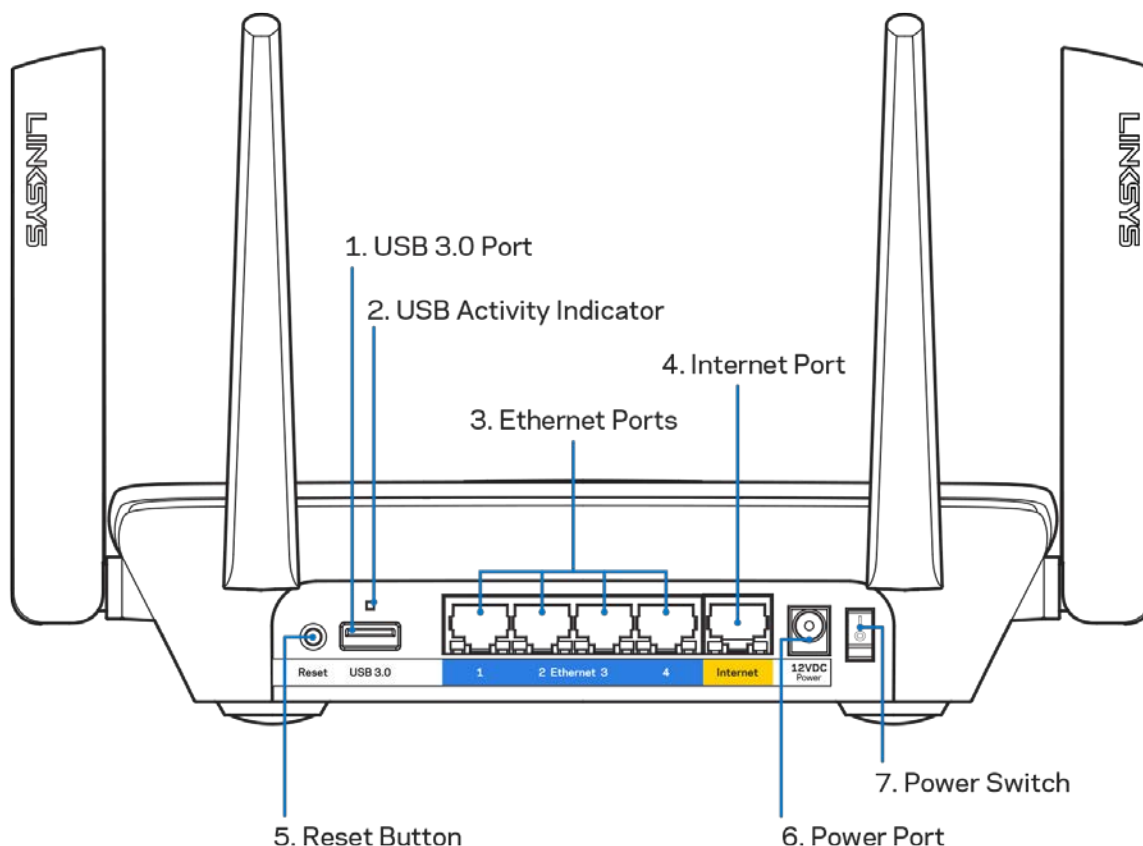

**Puerto USB 3.0 (1):** conecta y comparte unidades USB en tu red o en internet.

**Luz de actividad USB (2):** estas luces indican transferencias desde/a dispositivos externos.

**Puertos Ethernet (3):** conecta cable ethernet a estos puertos azules gigabit (10/100/1000) y a dispositivos con cable en tu red.

*Nota: para obtener el mejor rendimiento posible usa para los puertos Ethernet un cable CAT5e u otro de mayor calidad.*

**Puerto de internet: (4)** conecta un cable Ethernet a este puerto Gigabit amarillo (10/100/1000) y a un módem de banda ancha de cable/DSL o fibra óptica.

*Nota: para obtener el mejor rendimiento posible usa en el puerto de internet un cable CAT5e u otro de mayor calidad.*

**Botón de Reset (Restauración) (5):** presiona y mantén presionado hasta que el logotipo de Linksys se apague para volver a restablecer los valores de configuración por defecto del router. También puedes restaurar la configuración de fábrica usando la Linksys Smart Wi-Fi en internet o la aplicación móvil.

**Puerto de corriente (6):** conecta el adaptador de alimentación CA incluido.

**Interruptor de corriente (7):** presiona | (on) para encender el router.

## Vista lateral

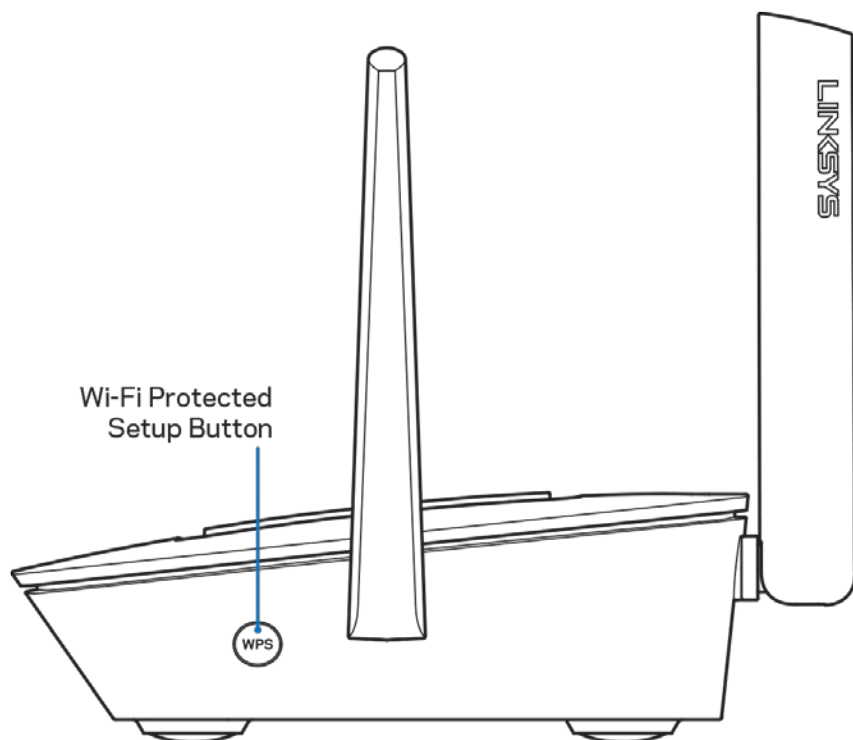

**Botón de Wi-Fi Protected Setup™:** presiona para conectar dispositivos de red habilitados con WPS.

# Instalación: Principios básicos

## Dónde encontrar más ayuda

Además de esta guía del usuario puedes obtener ayuda en:

- [Linksys.com/support/EA8300](http://Linksys.com/support/EA8300) (documentación, descargas, preguntas más frecuentes, servicio técnico, chat en vivo, foros)
- Ayuda para Linksys Smart Wi-Fi (conecta a la Linksys Smart Wi-Fi y a continuación haz clic en Ayuda, en la parte superior de la pantalla).

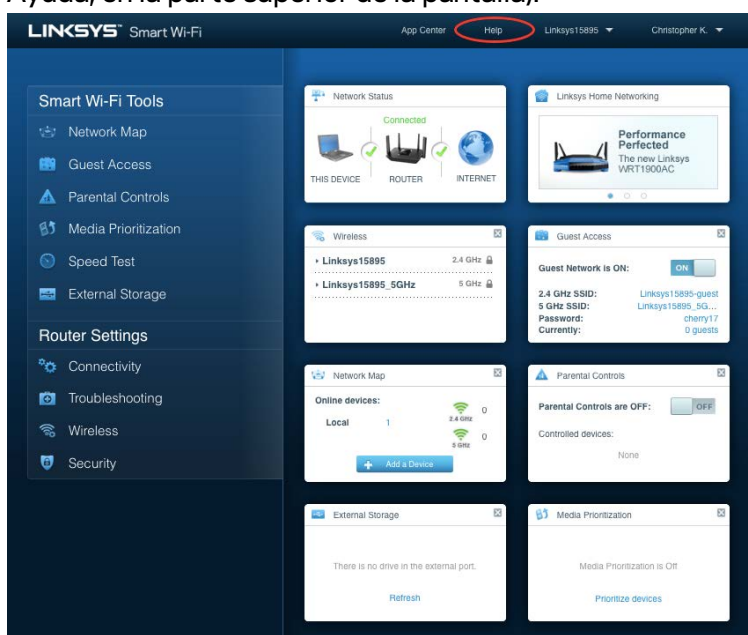

The screenshot shows the Linksys Smart Wi-Fi web interface. The top navigation bar includes 'App Center', 'Help' (highlighted with a red circle), 'Linksys15895', and 'Christopher K.'. The main content area is divided into several sections: 'Smart Wi-Fi Tools' (Network Map, Guest Access, Parental Controls, Media Prioritization, Speed Test, External Storage), 'Router Settings' (Connectivity, Troubleshooting, Wireless, Security), 'Network Status' (Connected), 'Linksys Home Networking' (Performance Perfected), 'Wireless' (2.4 GHz, 5 GHz), 'Guest Access' (Guest Network is ON), 'Network Map' (Online devices), 'Parental Controls' (Parental Controls are OFF), 'External Storage' (No drive), and 'Media Prioritization' (Media Prioritization is Off).

**Help**

**Using Linksys Smart Wi-Fi**

Linksys Smart Wi-Fi allows you to access all of your router's features and settings. Simply click on a feature or widget you want to open.

You can use Linksys Smart Wi-Fi to:

- See what's currently connected to your network, and connect more computers and devices.
- Create a Linksys Smart Wi-Fi account to access router settings from anywhere using any browser, even when you're away from home. You can personalize your router and change settings for wireless access, Internet, gaming, local network, and more. You can even access router settings for multiple routers, which is helpful if you set up and manage more than one router. (The account is available only on EA-Series routers.)
- Allow guests in your home to use the Internet without giving them access to your network. While on the guest network, users can surf the net, but won't be able to access your printers, other computers, or devices on your network.

**Help Categories**

- Linksys Smart Wi-Fi
- Device List
- Guest Access
- Parental Controls
- Media Prioritization
- Speed Test
- External Storage
- Connectivity

Ok

**Nota:** puede consultar las licencias y notas del software de terceros utilizado en este producto en <http://support.linksys.com/en-us/license>. Por favor, contacta con <http://support.linksys.com/en-us/gplcodecenter> para preguntas o solicitudes de código fuente GPL.

## Cómo instalar el router

1. Para completar la instalación necesitarás un ordenador para visitar en un explorador web <http://LinksysSmartWiFi.com>.
2. Identifica tu equipo.

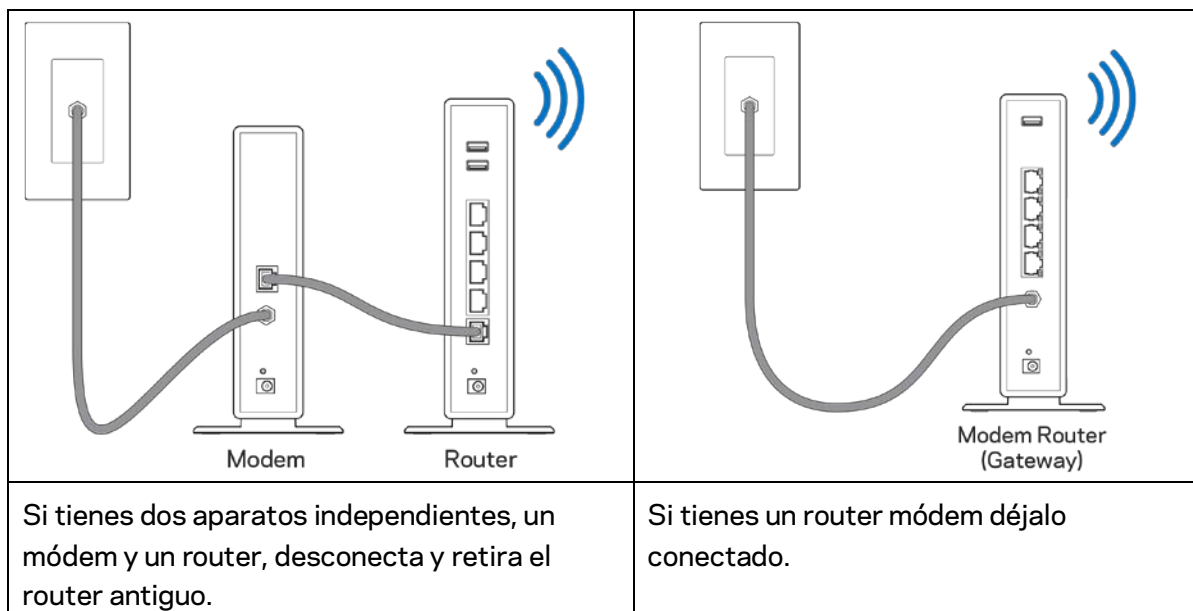

3. Posiciona las antenas en vertical y enchufa el router en una toma de corriente. Asegúrate de que el interruptor de corriente está en la posición | (on).
4. Conecta el router al módem o al router módem. Conecta un extremo del cable de internet al puerto amarillo de internet en el router nuevo. Si tienes un módem conecta el otro extremo en el puerto Ethernet (LAN) en el módem. Si tienes un router módem conéctalo en cualquier puerto disponible.
5. Espera a que la luz del logotipo de Linksys de la parte superior del router deje de parpadear y se encienda en blanco fijo.
6. Conecta al nombre de red inalámbrica que se muestra en la guía de inicio rápido incluida con el router (puedes cambiar estos valores posteriormente). Si necesitas ayuda para conectar a la red consulta la documentación del dispositivo en la página [linksys.com/support/EA8300](http://linksys.com/support/EA8300).

**Nota:** no contarás con acceso a internet hasta que hayas completado la instalación del router.

7. Escribe <http://LinksysSmartWiFi.com> en el explorador web. Sigue las instrucciones que aparecen en pantalla para finalizar la configuración del router. Puedes introducir también 192.168.1.1 en un explorador para iniciar la instalación.



Al final de la instalación sigue las instrucciones que aparecen en pantalla para configurar tu cuenta de Linksys Smart Wi-Fi. Usa la Linksys Smart Wi-Fi para configurar tu router desde cualquier ordenador con una conexión a internet.

Administra los valores de configuración del router:

- Cambia el nombre y la contraseña del router.
- Establece el acceso de invitados.
- Configura los controles parentales.
- Conecta dispositivos a tu Wi-Fi.
- Evalúa la velocidad de tu conexión a internet.

**Nota:** como parte del proceso de configuración de la cuenta de Linksys Smart Wi-Fi recibirás un correo electrónico de verificación. Desde tu red doméstica haz clic en el enlace del correo electrónico para asociar tu router con la cuenta de Linksys Smart Wi-Fi.

**Consejo:** imprime la siguiente página y a continuación anota para guardar como referencia los valores de configuración de su router y de la cuenta en la tabla. Guarda estas notas en un sitio seguro.

Nombre Wi-Fi de la red en la banda de 2,4 GHz	
Contraseña de Wi-Fi	
Nombre Wi-Fi de la red en la banda de 5 GHz <sub>1</sub>	
Contraseña de Wi-Fi	
Nombre Wi-Fi de la red en la banda de 5 GHz <sub>2</sub>	
Contraseña de Wi-Fi	
Contraseña del router	
Nombre Wi-Fi de la red invitados en la banda de 2,4 GHz	
Nombre Wi-Fi de la red invitados en la banda de 5 GHz	
Contraseña de la red Wi-Fi para invitados (ambas comparten una contraseña).	
Nombre de usuario de Linksys Smart Wi-Fi	
Contraseña de Linksys Smart Wi-Fi	

# Cómo usar la Linksys Smart Wi-Fi

Puedes gestionar tu router desde cualquier lugar del mundo usando Linksys Smart Wi-Fi. Por supuesto también lo puedes hacer estando conectado a tu red doméstica. Es posible igualmente que puedas utilizar Linksys Smart Wi-Fi desde tu dispositivo móvil. Consulta la tienda online de aplicaciones de tu dispositivo para obtener más información a este respecto.

## Cómo conectar a Linksys Smart Wi-Fi

Para conectar a Linksys Smart Wi-Fi:

1. Abre el explorador web de tu ordenador.
2. Ve a <http://LinksysSmartWiFi.com> e inicia allí la sesión de tu cuenta.

Linksys Smart Wi-Fi Sign In

If you have not yet created a Linksys Smart Wi-Fi account, click the 'Create Account' button in the upper right corner of the page.

Give guests Internet access

Use your Linksys Smart Wi-Fi account to access your home network from anywhere, at any time, even from your mobile device. Easily connect new devices, set parental controls, get access to Smart Wi-Fi mobile Apps, and more.

For more information click here

English (United States)

For local access, click here.

Si no recuerdas tu contraseña haz clic en *¿Olvidaste tu contraseña?* y sigue las instrucciones en pantalla para recuperarla.

## Mapa de red

Esta función te permite mostrar y gestionar todos los dispositivos de red conectados al router. Puedes ver los dispositivos de la red principal y la red de invitados o mostrar información acerca de cada dispositivo.



## Acceso de usuarios invitados

Te permite crear, configurar y monitorizar una red alternativa para usuarios invitados para que estos puedan conectarse por Wi-Fi sin que tu información personal esté expuesta.

The screenshot shows the 'Guest Access' configuration page. At the top, there's a title 'Guest Access' and a checkbox 'Show widget on the homepage' which is checked. Below the title, it says 'Guest access allows visitors to connect to your wireless guest network and access the Internet, without giving access to your other computers or personal data.' There are two main sections: 'Allow guest access' with a toggle switch set to 'ON', and 'Guest network names and password | Edit'. The 'Guest network names and password' section has two rows: '2.4 GHz SSID: parlor2.4' and '5 GHz SSID: parlor5', both with 'Network: Enabled'. Below that is 'Guest network password: thefly'. At the bottom, there's a 'Total guests allowed' section with a dropdown menu set to '5 guests'. 'OK' and 'Cancel' buttons are at the bottom right. A warning box on the right says: 'Your guest should first connect to your guest network, open a web browser, and then enter the guest password.'

## Controles parentales

Esta función te permite bloquear páginas web y fijar tiempos de acceso a internet.

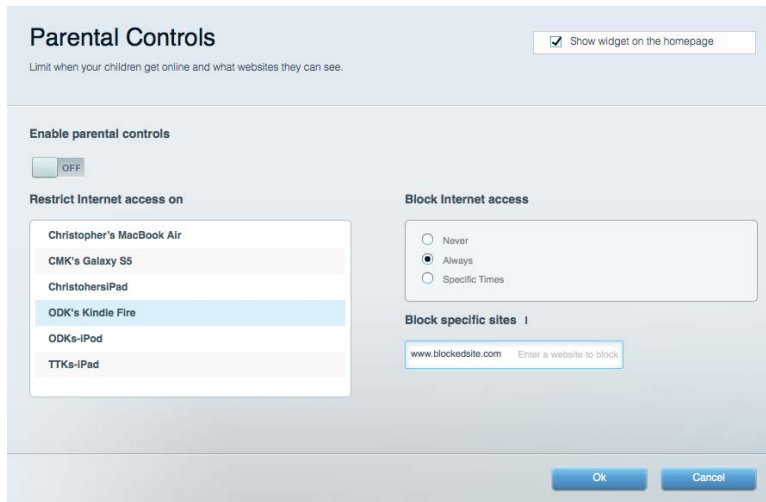

## Priorización del contenido multimedia

Te permite establecer qué dispositivos y aplicaciones tienen la máxima preferencia en el tráfico de tu red.

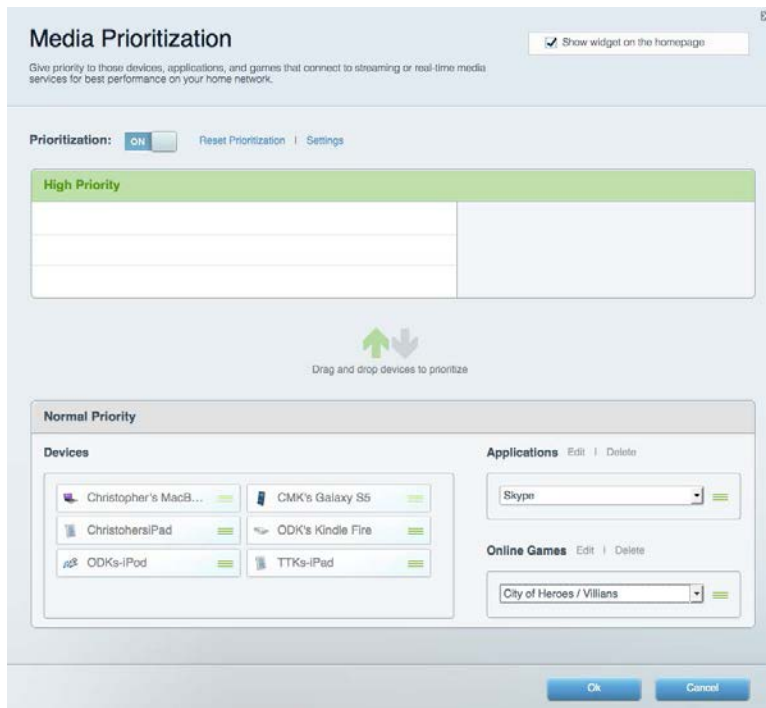

## Test de velocidad

Te permite evaluar la velocidad de tu conexión a internet.



## Almacenamiento externo

Te permite acceder a una unidad USB conectada (no incluida) y configurar el sistema para compartir archivos, un servidor multimedia o el acceso FTP.



## Conectividad

Te permite ver y cambiar los valores de configuración de la red básicos y avanzados.

The screenshot shows the 'Connectivity' settings page. It has a title bar with a close button. Below the title, there's a subtitle 'View and change router settings'. A navigation bar contains tabs for 'Basic', 'Internet Settings', 'Local Network', 'Advanced Routing', 'VLAN', and 'Administration'. The 'Basic' tab is selected. The page is divided into several sections: 'Network Name and Password' with fields for 2.4 GHz and 5 GHz network names and passwords; 'Router Password' with a masked password field; 'Router Firmware Update' with a checked 'Automatic' checkbox and a 'Check for Updates' button; 'Time Zone' with a dropdown menu set to '(GMT-05:00) Eastern Time (USA & Canada)' and a checked 'Automatically adjust for Daylight Savings Time' checkbox; and 'Activity Lights' with an 'ON' toggle and a text box. At the bottom, there are 'Ok', 'Cancel', and 'Apply' buttons.

## Resolución de problemas

Te permite diagnosticar problemas con el router y comprobar el estado de la red.

The screenshot shows the 'Troubleshooting' settings page. It has a title bar with a close button. Below the title, there's a subtitle 'Troubleshoot router settings'. A navigation bar contains tabs for 'Status', 'Diagnostics', and 'Logs'. The 'Diagnostics' tab is selected. The page is divided into several sections: 'Ping IPv4' with input fields for IP or host name and number of pings, and a 'Start to Ping' button; 'Trace route' with an input field for IP or host name and a 'Start to Traceroute' button; 'Reboot' with a 'Reboot the router' link; 'Router configuration' with 'Backup' and 'Restore' buttons; 'Router Firmware' with a 'Restore previous firmware' button; 'Internet Address' with IPv4 and IPv6 addresses and 'Release and Renew' links; and 'Factory reset' with a 'Reset to factory default settings' link. At the bottom, there is an 'Ok' button.

## Red inalámbrica

Te permite ver y cambiar la red inalámbrica del router. Puedes cambiar nombres de red, el modo de seguridad, la contraseña, el filtrado MAC y conectar dispositivos usando Wi-Fi Protected Setup.

The screenshot shows the 'Wireless' settings page. At the top, there's a 'Show widget on the homepage' checkbox which is checked. Below that, there are tabs for 'Wireless', 'MAC Filtering', and 'Wi-Fi Protected Setup'. The 'Smart Connect' section has two radio buttons: '5 GHz band steering' (selected) and 'Off'. Below this, there are two network configuration sections. The first is for the 2.4 GHz network, with 'Network name' set to 'arachnid', 'Password' to 'peterparker', 'Broadcast SSID' to 'Yes', 'Channel' to 'Auto', and 'Security mode' to 'WPA2/WPA Mixed Pk'. The second is for the 5 GHz network, with 'Network name' set to 'arachnid\_5GHz', 'Password' to 'peterparker', 'Broadcast SSID' to 'Yes', 'Channel' to 'Auto', and 'Security mode' to 'WPA2/WPA Mixed Pk'. At the bottom, there are 'Ok', 'Cancel', and 'Apply' buttons.

## Seguridad

Te permite ver y cambiar la seguridad inalámbrica de tu router. Puedes configurar el firewall y los parámetros VPN, y crear parámetros predeterminados para aplicaciones y juegos.

The screenshot shows the 'Security' settings page. At the top, there's a 'View and change router settings' link. Below that, there are tabs for 'Firewall', 'DMZ', and 'Apps and Gaming'. The 'Firewall' section is active and contains several sub-sections. 'Internet filters' has three checkboxes: 'Filter anonymous Internet requests' (checked), 'Filter multicast' (unchecked), and 'Filter Internet NAT redirection' (unchecked). 'VPN Passthrough' has three checkboxes: 'IPSec Passthrough' (checked), 'PPTP Passthrough' (checked), and 'L2TP Passthrough' (checked). 'IPv6 Port Services' is a table with columns for 'Description', 'Protocol', 'IPv6 Address', 'Allow', and 'Enabled'. At the bottom, there are 'Ok', 'Cancel', and 'Apply' buttons.

Description	Protocol	IPv6 Address	Allow	Enabled



# Resolución de problemas

Puede obtener más ayuda consultando nuestro galardonado servicio de atención al cliente en [linksys.com/support/EA8300](http://linksys.com/support/EA8300).

## El router no se ha configurado correctamente

Si Linksys Smart Wi-Fi no ha completado la configuración puedes probar lo siguiente:

- Presiona y mantén presionado el botón de Reset (Restauración) usando un clip o un imperdible hasta que el logotipo iluminado de Linksys se apague y los indicadores MU-MIMO azules comiencen a parpadear (unos 10 segundos). Instala de nuevo el router.

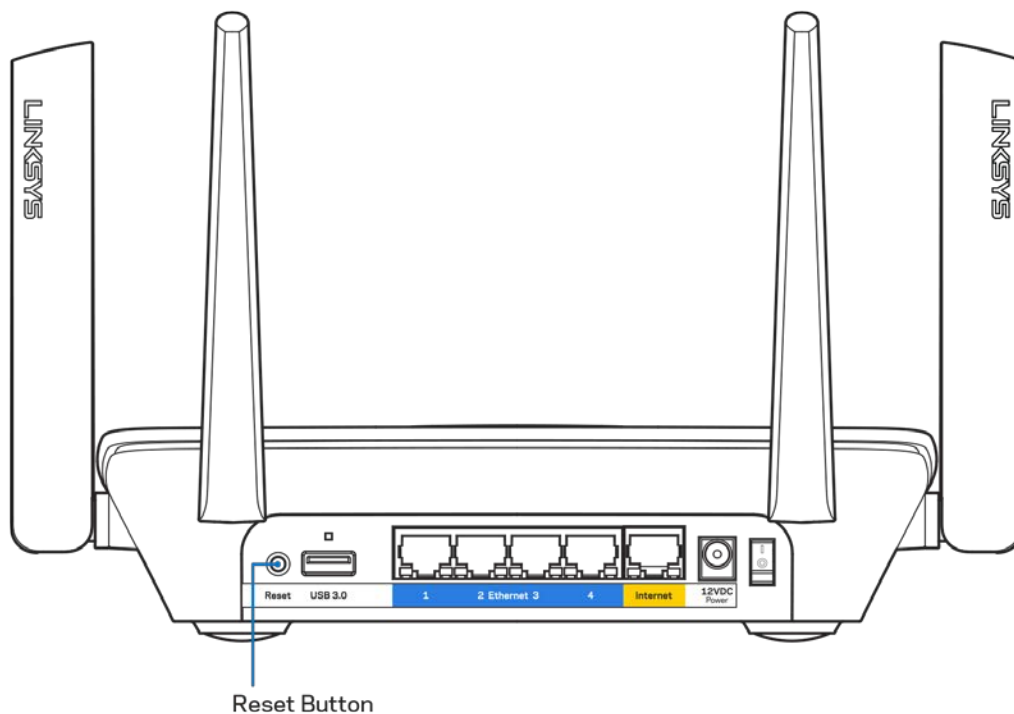

- Deshabilita temporalmente el firewall del ordenador (consulta las instrucciones del software de seguridad para obtener ayuda). Instala de nuevo el router.
- Si tienes otro ordenador útilízalo para volver a instalar el router de nuevo.

## ***Mensaje «El cable de internet no está conectado»***

Si aparece el mensaje «El cable de internet no está conectado» cuando intentas configurar el router sigue estos pasos de resolución de problemas.

- Asegúrate de que hay un cable de Ethernet o internet (o un cable idéntico al incluido con el router) bien conectado al puerto WAN amarillo en el router y al puerto apropiado en tu router. Este puerto del módem suele estar etiquetado como Ethernet.

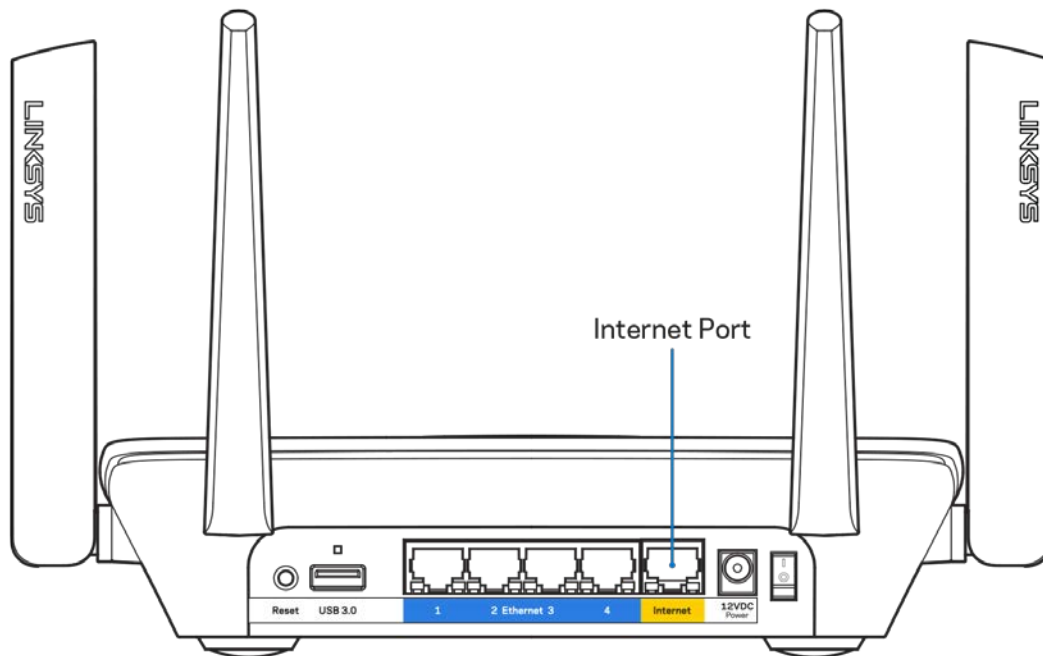

- Asegúrate de que el módem esté enchufado y encendido. Si está provisto de un interruptor de alimentación comprueba que está fijado en la posición ON o | (y no en O).

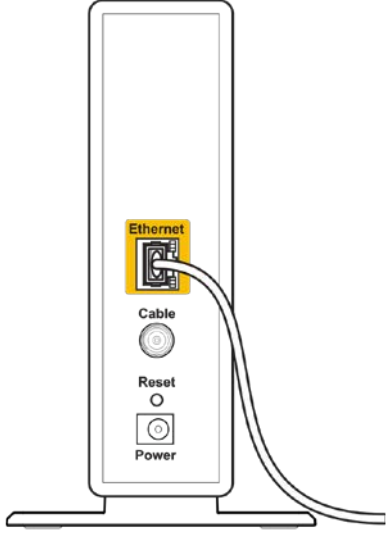
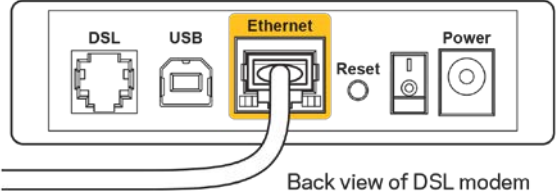
 <p style="text-align: center;">Back view of cable modem</p>	 <p style="text-align: center;">Back view of DSL modem</p>
<p>Si tu servicio de internet es por cable verifica que el cable coaxial suministrado por su ISP está bien conectado al puerto de CABLE del cable-módem.</p>	<p>Si tu servicio de internet es DSL asegúrate de que la línea de teléfono DSL está conectada al puerto DSL del módem.</p>

- Si el ordenador estaba conectado anteriormente al módem mediante un cable USB desconecta dicho cable.
- Instala de nuevo el router.

### ***Mensaje «No se puede acceder al router»***

Para acceder al router debes estar conectado a tu propia red. Si tienes un acceso inalámbrico a internet el problema puede ser que te has conectado accidentalmente a una red inalámbrica distinta.

Para resolver el problema en ordenadores con Windows haz lo siguiente:

1. Haz clic sobre el icono de señal inalámbrica en la bandeja del sistema. Aparecerá una lista de las redes inalámbricas disponibles.

2. Haz clic en el nombre de tu red. Haz clic en Conectar. En el ejemplo que se muestra a continuación, el ordenador estaba conectado a otra red inalámbrica con el nombre wraith\_5GHz. El nombre de red inalámbrica del router Linksys EA8300, Damaged\_Beez2.4 en este ejemplo se muestra seleccionado.



3. Si se te solicita que introduzcas una clave de red escribe tu contraseña (clave de seguridad) en el campo de *clave de seguridad*. Haz clic en **Aceptar**.
4. Tu ordenador se conectará a la red y ya deberías poder acceder al router.

*\*Dependiendo de tu versión de Windows es posible que existan algunas diferencias en el texto específico o los iconos contenidos en estos pasos.*

Para solucionar el problema en ordenadores Mac haz lo siguiente:

1. Haz clic en el icono Wi-Fi de la barra de menús situada en la parte superior de la pantalla. Aparecerá una lista de las redes inalámbricas.
2. En el ejemplo que se muestra a continuación el ordenador estaba conectado a otra red inalámbrica con el nombre wraith\_5GHz. El nombre de red inalámbrica del router Linksys EA8300, Damaged\_Beez2.4 en este ejemplo se muestra seleccionado.

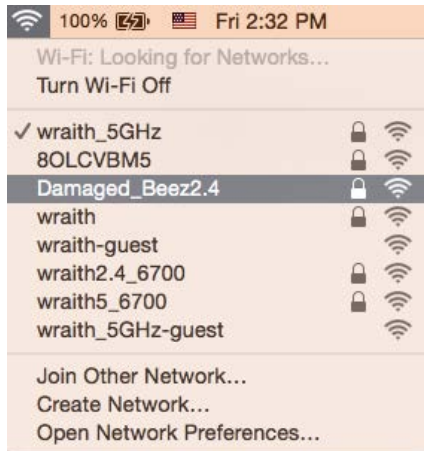

3. Haz clic en el nombre de red inalámbrica de su router EA8300 (Damaged\_Beez2.4 en el ejemplo).
4. Escribe tu contraseña de red inalámbrica (clave de seguridad) en el campo de *Contraseña*. Haz clic en **Aceptar**.

## Tras la instalación

### Parece que no hay conexión a internet disponible

Si se producen dificultades de conexión entre internet y tu router el problema puede manifestarse con un mensaje de «No se puede encontrar [dirección de internet]» en el explorador web. Si tienes la certeza de que la dirección de internet es correcta y lo has intentado varias veces con distintas direcciones de internet válidas con el mismo resultado el mensaje podría significar que existe un problema con tu ISP o con la comunicación entre el router y el módem. Intenta hacer lo siguiente:

- Asegúrate de que la red y los cables de corriente están correctamente conectados.
- Asegúrate de que la toma de corriente a la que el router está enchufado suministra electricidad.
- Reinicia el router.
- Contacta con tu ISP y pregunta si se están produciendo apagones en tu área.

El método más común para resolver problemas con el router es apagarlo y volverlo a encender. Tu router puede cargar de nuevo sus parámetros de configuración personalizados y otros dispositivos (como el módem) podrán encontrar de nuevo el router y comunicarse con él. Este proceso se denomina reinicio.

Para reiniciar tu router usando el cable de corriente haz lo siguiente:

1. Desconecta el cable de corriente del router y del módem.
2. Espera 10 segundos y vuelve a conectar el cable al módem. Asegúrate de que este recibe corriente.
3. Espera hasta que el indicador online del módem haya parado de parpadear (unos dos minutos). Vuelve a conectar el cable de corriente al router.

4. Espera hasta que se ilumine el logotipo de Linksys. Espera dos minutos antes de intentar conectarte de nuevo a internet desde un ordenador.

Para reiniciar el router usando la Linksys Smart Wi-Fi haz lo siguiente:

1. Inicia la sesión en Linksys Smart Wi-Fi (consulta «Cómo conectar a Linksys Smart Wi-Fi» en la página [11](#)).
2. Bajo *Ajustes del router* haz clic en *Resolución de problemas*
3. Haz clic en la pestaña de *Diagnósticos*.
4. Bajo *Reinicio del sistema* haz clic en Reiniciar.



5. Haz clic en **Sí**. El router se reiniciará. Mientras que el router se está reiniciando todos los dispositivos conectados perderán su conexión a internet y se conectarán automáticamente cuando el router esté listo de nuevo.

## Linksys Smart Wi-Fi no se abre en tu explorador web

Las últimas versiones de Google Chrome™, Firefox®, Safari® (para Mac® y iPad®), Microsoft Edge y Internet Explorer® versión 8 y más recientes funcionan con Linksys Smart Wi-Fi.

# Especificaciones

## Linksys EA8300

Nombre del modelo	Router Gigabit MU-MIMO Tribanda AC5400 Max-Stream de Linksys
Número del modelo	EA8300
Velocidad de puerto de switch	10/100/1000 Mbps (Gigabit Ethernet)
Radiofrecuencia	2,4 GHz y 5 GHz (x2)
N.º de antenas	4 antenas externas ajustables (no extraíbles)
Puertos	USB.3.0, Ethernet (1-4), Internet, Corriente
Botones	Wi-Fi Protected Setup, Corriente, Reset (Restauración)
Luces	<b>Panel superior:</b> Logotipo iluminado de Linksys, Wi-Fi Protected Setup, conexión de internet, conexión del cable de red al puerto de internet <b>Panel trasero:</b> USB, Ethernet (1-4), Internet
UPnP	Compatible
Funciones de seguridad	WEP, WPA2, RADIUS
Bits de clave de seguridad	Encriptación de hasta 128 bits
Compatibilidad con sistema de archivos de almacenamiento	FAT, NTFS y HFS+
Compatibilidad con exploradores web	Las últimas versiones de Google Chrome™, Firefox®, Safari® (para Mac® y iPad®), Microsoft Edge y Internet Explorer® versión 8 y posteriores

## Datos físicos

Dimensiones	213,7mm x 161,8mm x 54,8mm (sin antenas)
Peso de la unidad	608 g
Alimentación	12 V, 2 A
Certificaciones	FCC, IC, CE, Wi-Fi (a/b/g/n/ac)
Temperatura de funcionamiento	Entre 0 y 40 °C
Temperatura de almacenamiento	Entre -20 y 60 °C
Humedad de funcionamiento	Entre 10 % y 80 % de humedad relativa sin condensación
Humedad de almacenamiento	Entre 5 % y 90 % sin condensación

Las especificaciones están sujetas a cambios sin previo aviso.

Notas:

Para obtener información sobre el cumplimiento normativo, la garantía y la seguridad consulte el CD incluido con el router o vaya a [Linksys.com/support/EA8300](http://Linksys.com/support/EA8300).

Rendimiento máximo según lo establecido en las especificaciones de la norma IEEE 802.11. El rendimiento real puede variar y la capacidad de red inalámbrica, el índice de producción de datos, el alcance y la cobertura pueden disminuir. El rendimiento depende de numerosos factores, condiciones y variables, entre ellos, la distancia desde el punto de acceso, el volumen de tráfico de la red, los materiales de construcción de la vivienda, el sistema operativo utilizado, la combinación de productos inalámbricos presentes en la red, posibles interferencias y otras condiciones adversas.

BELKIN, LINKSYS y otros nombres y logotipos de productos son marcas comerciales del grupo de empresas Belkin. Las marcas comerciales de terceros mencionadas pertenecen a sus respectivos propietarios. Licencias y notas de aviso para software de terceros usados en este producto pueden ser consultadas aquí: <http://support.linksys.com/en-us/license>. Por favor, ponte en contacto a través de <http://support.linksys.com/en-us/gplcodecenter> para cualquier pregunta o solicitud de código fuente GPL.

© 2017 Belkin International, Inc. y/o sus filiales. Todos los derechos reservados.



**LINKSYS®**

Guide d'utilisation

**MAX-STREAM™**  
**AC2200 MU-MIMO**  
**ROUTEUR TRIBANDE**

Modèle EA8300

# Table des matières

Vue d'ensemble du produit .....	3
Vue du dessus.....	3
Indicateur d'état système .....	4
Vue arrière .....	5
Vue latérale.....	6
Configuration : Fonctions de base .....	7
Où trouver de plus amples renseignements .....	7
Installation de votre routeur.....	8
Comment utiliser le Sans-fil intelligent Linksys.....	11
Connexion à Sans-fil intelligent Linksys.....	11
Carte du réseau.....	12
Accès d'invité.....	12
Contrôle parental.....	13
Priorisation des sources de lecture.....	13
Test de vitesse .....	14
Stockage externe.....	14
Connectivité.....	15
Dépannage.....	15
Sans-fil .....	16
Sécurité.....	16
Dépannage .....	17
Votre routeur n'a pas été configuré correctement.....	17
Message <i>Votre câble Internet n'est pas branché</i> .....	18
Message <i>Impossible d'accéder à votre routeur</i> .....	19
Une fois la configuration terminée .....	21
Internet ne semble pas disponible.....	21
Le Sans-fil intelligent Linksys ne s'ouvre pas dans votre navigateur Web .....	22
Caractéristiques techniques .....	23
Linksys EA8300 .....	23
Environnement d'exploitation.....	23

# Vue d'ensemble du produit

## Vue du dessus

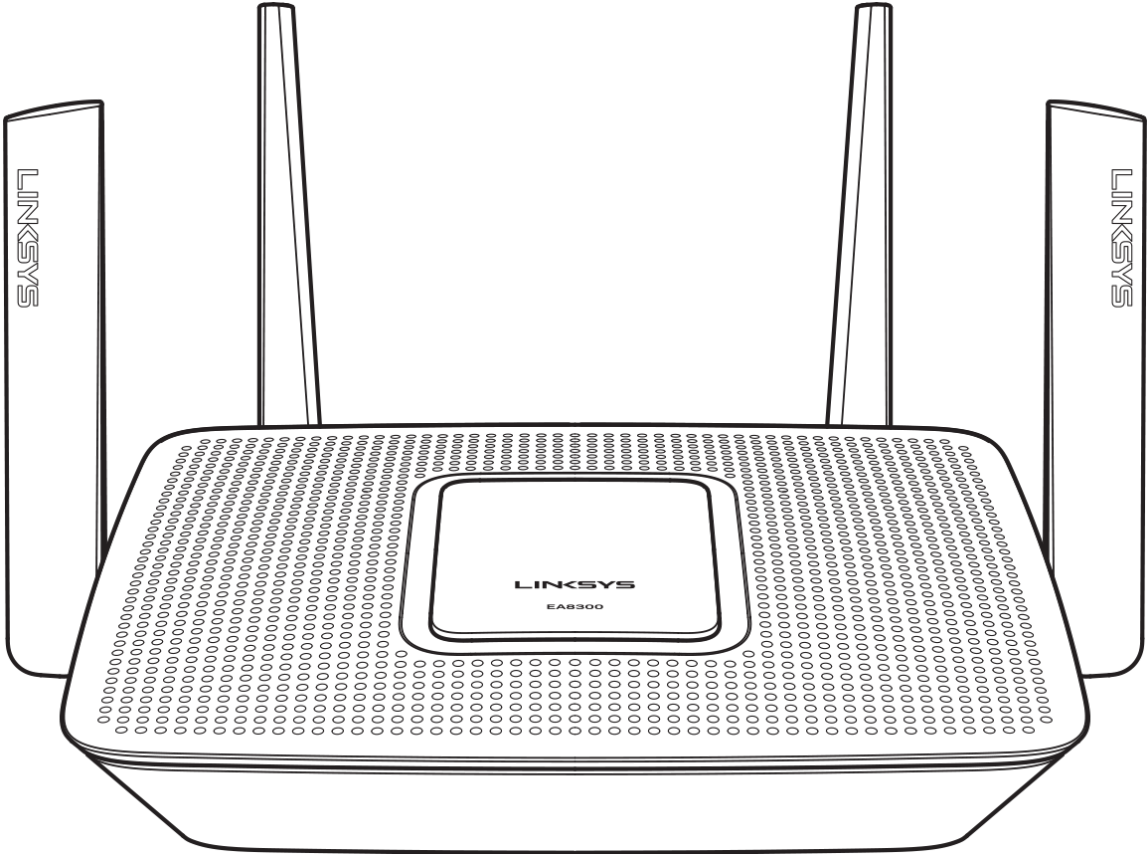

## Indicateur d'état système

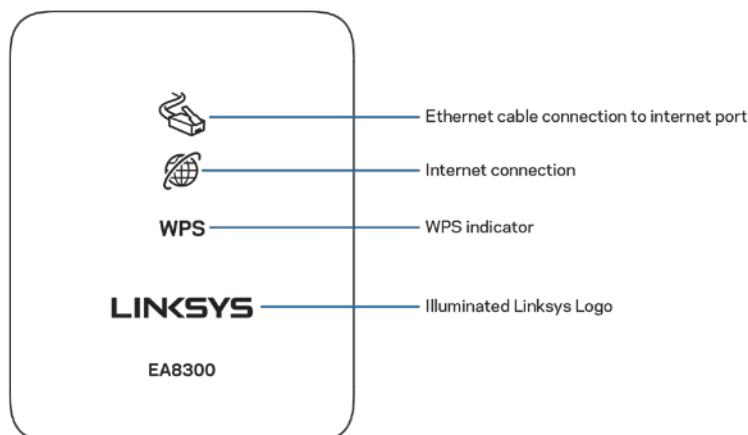

**Connexion du câble Ethernet au port Internet :** lorsqu'il est allumé (orange), ce voyant indique un problème avec le câble réseau branché au port Internet (WAN).

**Connexion Internet :** lorsqu'il est allumé (orange), ce voyant indique que le routeur ne peut pas accéder à Internet.

**Indicateur WPS (Wi-Fi Protected Setup™) :** le voyant WPS a quatre états :

<b>Éteint</b>	Aucune activité Wi-Fi Protected Setup
<b>Blanc clignotant</b>	Configuration Wi-Fi Protected Setup en cours
<b>Blanc fixe</b>	Configuration Wi-Fi Protected Setup réussie; reste allumé pendant cinq secondes
<b>Orange clignotant</b>	Erreur de configuration Wi-Fi Protected Setup; clignote pendant une minute, puis s'éteint

**Logo Linksys lumineux :** clignote pendant le démarrage du routeur. Quand le logo est blanc fixe, le routeur est sous tension et fonctionne correctement.

## Vue arrière

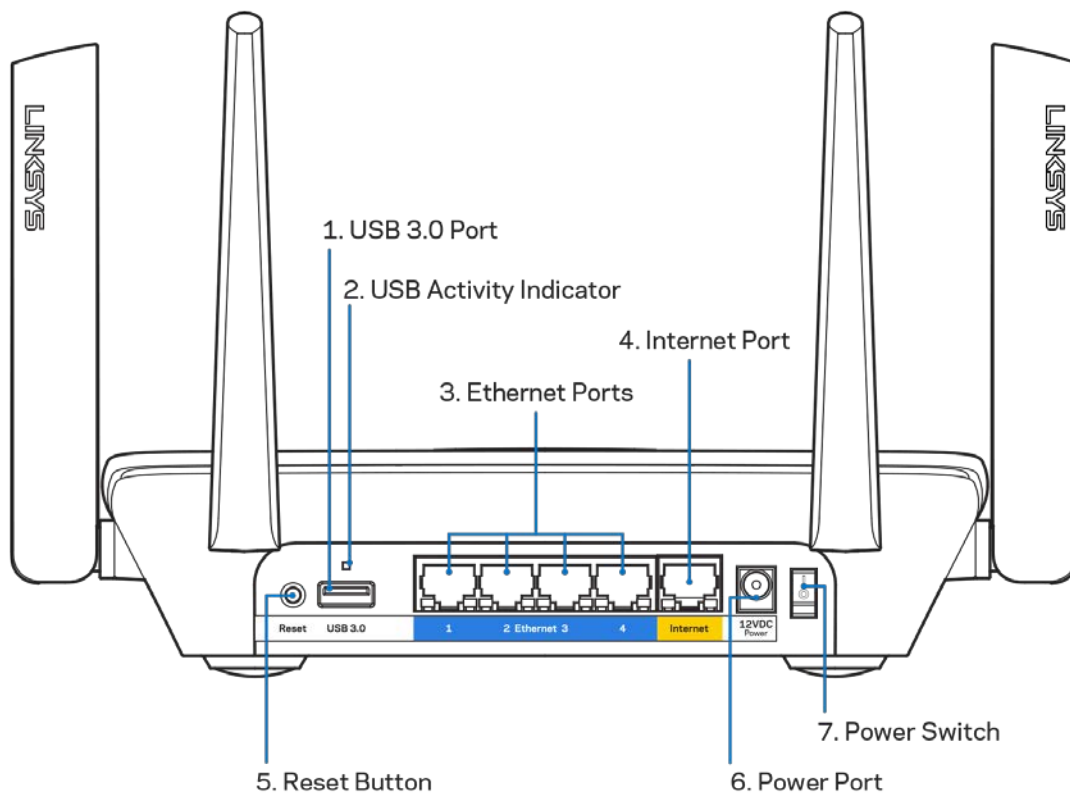

**Port USB 3.0 (1) :** branchez et partagez des périphériques de stockage USB sur votre réseau ou sur Internet.

**Témoin d'activité USB (2) :** les voyants indiquent le transfert de données à partir de et vers des dispositifs externes.

**Ports Ethernet (3) :** branchez des câbles Ethernet sur ces ports Gigabit (10/100/1000) bleus et aux périphériques connectés à votre réseau en mode filaire.

*Remarque : pour une performance optimale, utilisez des câbles CAT5e ou de catégorie supérieure sur les ports Ethernet.*

**Port Internet (4) :** branchez un câble Ethernet sur ce port Gigabit (10/100/1000) jaune et sur un modem câble/DSL Internet à large bande ou fibre optique.

*Remarque : pour une performance optimale, utilisez un câble CAT5e ou de catégorie supérieure sur le port Internet.*

**Bouton Reset (réinitialisation) (5) :** maintenez ce bouton enfoncé jusqu'à ce que le logo lumineux Linksys s'éteigne pour réinitialiser le routeur aux paramètres établis par défaut à l'usine. Vous pouvez également réinitialiser les paramètres par défaut à l'aide du site Internet ou de l'application mobile du Sans-fil intelligent Linksys.

**Port d'alimentation (6) :** branchez le bloc d'alimentation en c.a. fourni.

**Interrupteur marche/arrêt (7) :** appuyez sur | (marche) pour mettre le routeur sous tension.

## Vue latérale

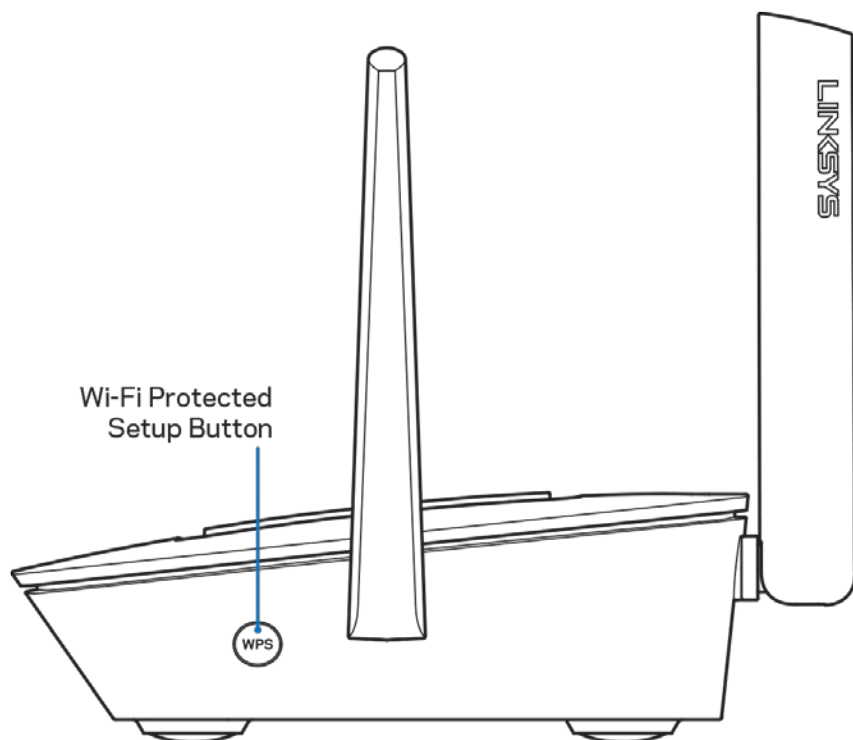

**Bouton Wi-Fi Protected Setup™** : appuyez pour vous connecter à des périphériques réseau compatibles WPS.

# Configuration : Fonctions de base

## Où trouver de plus amples renseignements

Outre le présent Guide d'utilisation, vous trouverez des renseignements supplémentaires aux emplacements suivants :

- [Linksys.com/support/EA8300](http://Linksys.com/support/EA8300) (documentation, téléchargements, FAQ, soutien technique, clavardage en direct, forums)
- Aide de Sans-fil intelligent Linksys (connectez-vous à Sans-fil intelligent Linksys, puis cliquez sur Aide en haut de l'écran)

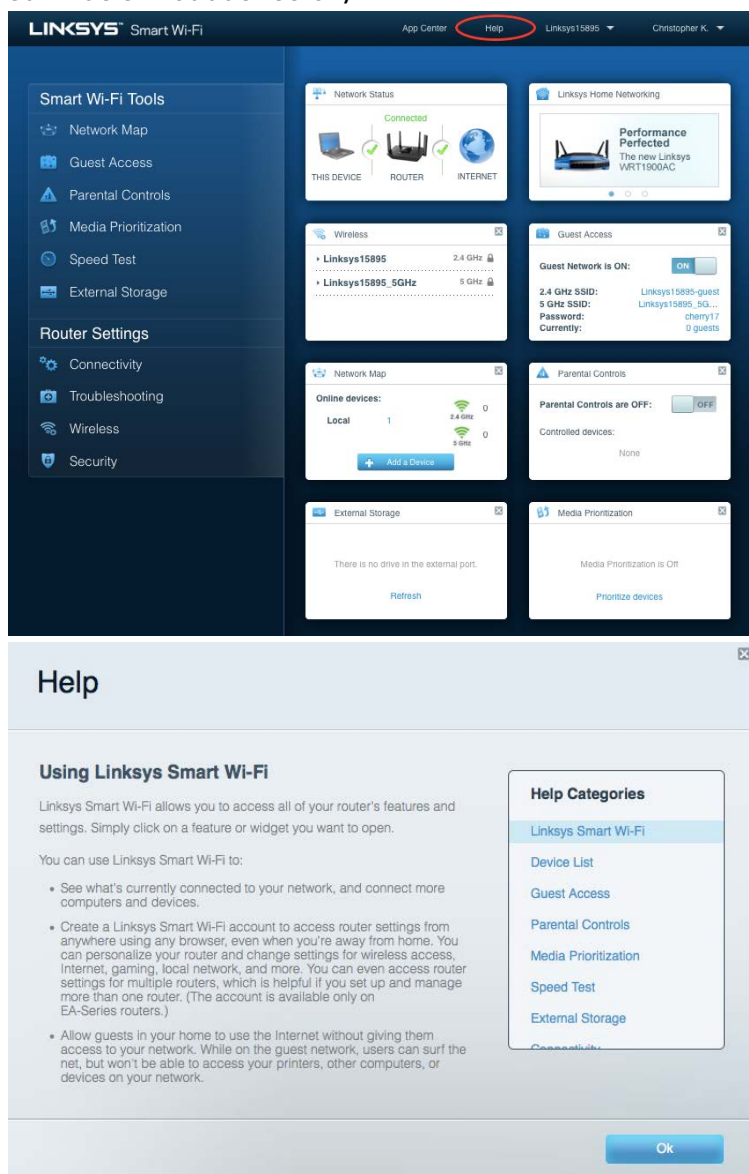

The image shows a screenshot of the Linksys Smart Wi-Fi web interface. At the top, the navigation bar includes 'App Center', 'Help' (highlighted with a red circle), 'Linksys15895', and 'Christopher K.'. The main dashboard is divided into several sections: 'Smart Wi-Fi Tools' (Network Map, Guest Access, Parental Controls, Media Prioritization, Speed Test, External Storage), 'Router Settings' (Connectivity, Troubleshooting, Wireless, Security), 'Network Status' (showing 'Connected' status for 'THIS DEVICE', 'ROUTER', and 'INTERNET'), 'Linksys Home Networking' (Performance Perfected), 'Wireless' (showing 'Linksys15895' on 2.4 GHz and 'Linksys15895\_5GHz' on 5 GHz), 'Guest Access' (Guest Network is ON), 'Network Map' (Online devices: Local 1, 2.4 GHz 0, 5 GHz 0), 'Parental Controls' (Parental Controls are OFF), 'External Storage' (There is no drive in the external port), and 'Media Prioritization' (Media Prioritization is Off). Below the dashboard is a 'Help' section with the title 'Using Linksys Smart Wi-Fi' and a list of 'Help Categories' including 'Linksys Smart Wi-Fi', 'Device List', 'Guest Access', 'Parental Controls', 'Media Prioritization', 'Speed Test', and 'External Storage'. An 'Ok' button is located at the bottom right of the help page.

**Remarque :** les licences et la documentation relatives aux logiciels tiers utilisés dans ce produit peuvent être consultées à l'adresse suivante : <http://support.linksys.com/en-us/license>. Pour toute demande relative au code source LPG ou toute autre question, veuillez communiquer avec nous à l'adresse <http://support.linksys.com/en-us/gplcodecenter>.

## Installation de votre routeur

1. Pour effectuer la configuration, vous aurez besoin d'un ordinateur pour consulter le site <http://LinksysSmartWiFi.com> sur un navigateur Web.
2. Identifiez votre équipement.

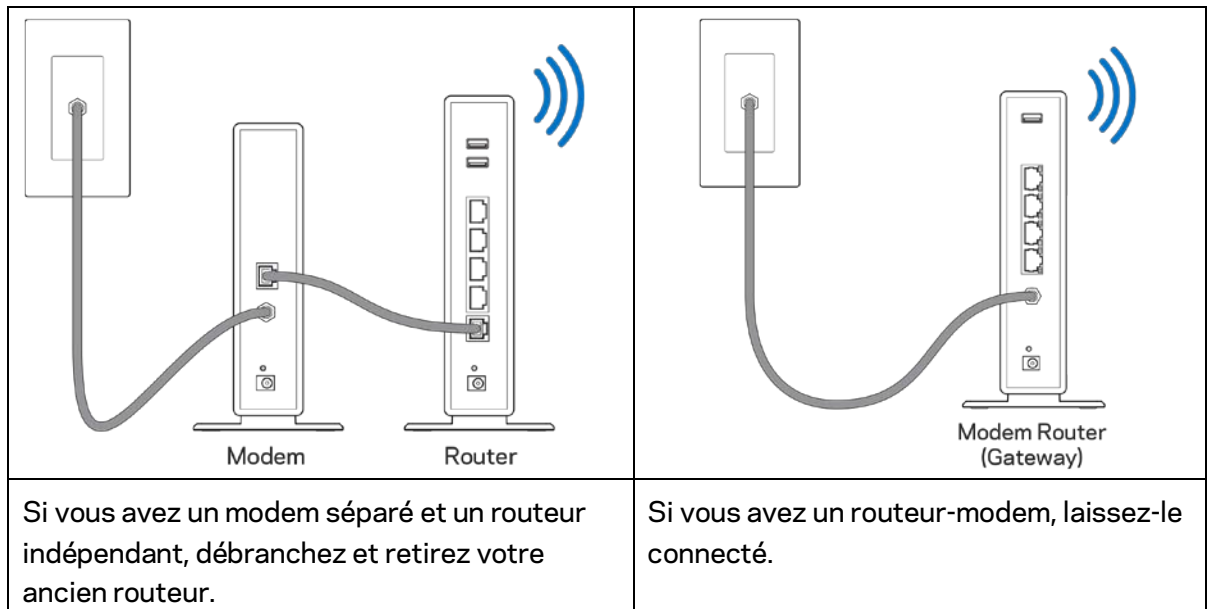

3. Positionnez les antennes à la verticale et branchez le routeur à une source d'alimentation. Assurez-vous que l'interrupteur d'alimentation est en position | (marche).
4. Raccordez votre routeur à votre modem ou routeur-modem. Branchez une extrémité du câble Internet fourni dans le port Internet jaune à l'arrière de votre nouveau routeur. Si vous avez un modem, branchez l'autre extrémité dans le port Ethernet (LAN) sur le modem. Si vous avez un routeur-modem, branchez l'autre extrémité dans tout port disponible.
5. Patientez jusqu'à ce que le logo lumineux Linksys sur la partie supérieure du routeur arrête de clignoter et soit blanc fixe.
6. Connectez-vous au nom de réseau sans fil indiqué dans le Guide de démarrage rapide fourni avec votre routeur. (Vous pourrez modifier ces renseignements ultérieurement.) Si vous avez besoin d'aide pour vous connecter au réseau, reportez-vous à la documentation de votre appareil à l'adresse [linksys.com/support/EA8300](http://linksys.com/support/EA8300).

**Remarque :** vous n'aurez pas accès à Internet tant que le routeur n'aura pas été intégralement configuré.



7. Entrez <http://LinksysSmartWiFi.com> dans un navigateur Web. Suivez les instructions à l'écran pour configurer votre routeur. Vous pouvez également entrer 192.168.1.1 dans un navigateur pour commencer la configuration.

À la fin de l'installation, suivez les instructions à l'écran pour configurer votre compte Sans-fil intelligent Linksys. Utilisez Sans-fil intelligent Linksys pour configurer votre routeur à partir de n'importe quel ordinateur connecté à Internet.

Gérez les paramètres de votre routeur :

- modification du nom du routeur et du mot de passe;
- configuration de l'accès d'invités;
- configuration du contrôle parental;
- ajout de périphériques à votre réseau sans-fil;
- vérification de la vitesse de votre connexion Internet.

**Remarque :** *lors de la configuration du compte Sans-fil intelligent Linksys, vous recevrez un courriel de vérification. À partir de votre réseau domestique, cliquez sur le lien dans le courriel pour associer votre routeur au compte Sans-fil intelligent Linksys.*

**Conseil :** *imprimez la page suivante, puis inscrivez les paramètres du routeur et de votre compte au tableau à titre de référence. Rangez vos notes dans un endroit sûr.*

Nom du réseau sans-fil 2,4 GHz	
Mot de passe du réseau sans-fil	
Nom du réseau sans-fil 5 GHz <sub>1</sub>	
Mot de passe du réseau sans-fil	
Nom du réseau sans-fil 5 GHz <sub>2</sub>	
Mot de passe du réseau sans-fil	
Mot de passe du routeur	
Nom du réseau sans-fil d'invité 2,4 GHz	
Nom du réseau sans-fil d'invité 5 GHz	
Mot de passe du réseau sans-fil d'invité (les deux réseaux partagent un même mot de passe).	
Nom d'utilisateur Sans-fil intelligent Linksys	
Mot de passe Sans-fil intelligent Linksys	

# Comment utiliser le Sans-fil intelligent Linksys

Vous pouvez gérer votre routeur à partir de n'importe quel endroit dans le monde grâce à Sans-fil intelligent Linksys mais aussi, directement à partir de votre réseau domestique. Sans-fil intelligent Linksys peut même être accessible à partir de votre appareil mobile. Visitez la boutique d'applications de votre appareil pour de plus amples renseignements à ce sujet.

## Connexion à Sans-fil intelligent Linksys

Pour vous connecter à Sans-fil intelligent Linksys :

1. Ouvrez votre navigateur Web sur votre ordinateur.
2. Allez à <http://LinksysSmartWiFi.com> et accédez à votre compte.



Linksys Smart Wi-Fi Sign In

If you have not yet created a Linksys Smart Wi-Fi account, click the "Create Account" button in the upper right corner of the page.

Give guests Internet access

Use your Linksys Smart Wi-Fi account to access your home network from anywhere, at any time, even from your mobile device. Easily connect new devices, set parental controls, get access to Smart Wi-Fi mobile Apps, and more.

For more information [click here](#)

English (United States)

For local access, [click here](#).

Si vous ne vous souvenez pas de votre mot de passe, cliquez sur *Forgot your password?* (Mot de passe oublié?) et suivez les instructions à l'écran pour le récupérer.

## Carte du réseau

Cela vous permet d'afficher et de gérer tous les périphériques connectés à votre routeur. Vous pouvez voir quels périphériques sont connectés à votre réseau principal et à votre réseau d'invités ou afficher des renseignements sur chacun de ces périphériques.



## Accès d'invité

Cela vous permet de configurer et de surveiller un réseau par lequel vos invités peuvent accéder au sans-fil sans exposer vos informations personnelles.

The screenshot shows the 'Guest Access' configuration page. At the top, there's a title 'Guest Access' and a checkbox 'Show widget on the homepage' which is checked. Below the title, it says 'Guest access allows visitors to connect to your wireless guest network and access the Internet, without giving access to your other computers or personal data.' There are two main sections: 'Allow guest access' with a toggle switch set to 'ON', and 'Guest network names and password' with an 'Edit' link. The 'Guest network names and password' section has two rows: '2.4 GHz SSID: parlor2.4' and '5 GHz SSID: parlor5', both with 'Network: Enabled'. Below that is 'Guest network password: thefly'. At the bottom, there's a 'Total guests allowed' section with a dropdown menu set to '5 guests'. 'OK' and 'Cancel' buttons are at the bottom right. A warning box on the right says: 'Your guest should first connect to your guest network, open a web browser, and then enter the guest password.'

## Contrôle parental

Cela vous permet de bloquer l'accès à des sites Web et de définir des heures d'accès à Internet.

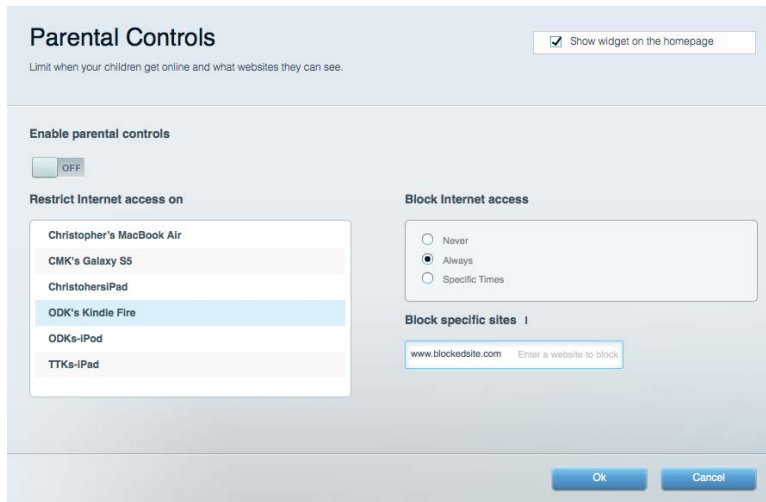

## Priorisation des sources de lecture

Cela vous permet de définir quels sont les périphériques et applications prioritaires en termes de trafic réseau.

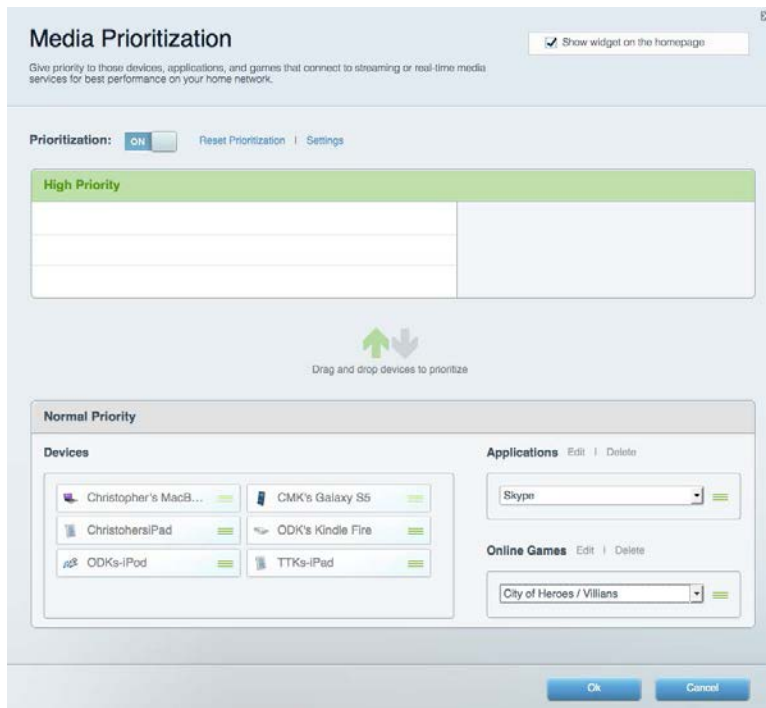

## Test de vitesse

Cela vous permet de vérifier la vitesse de la connexion Internet de votre réseau.



## Stockage externe

Cela vous permet d'accéder à un périphérique USB connecté (non fourni) et de configurer le partage de fichiers, un serveur multimédia et l'accès à FTP.

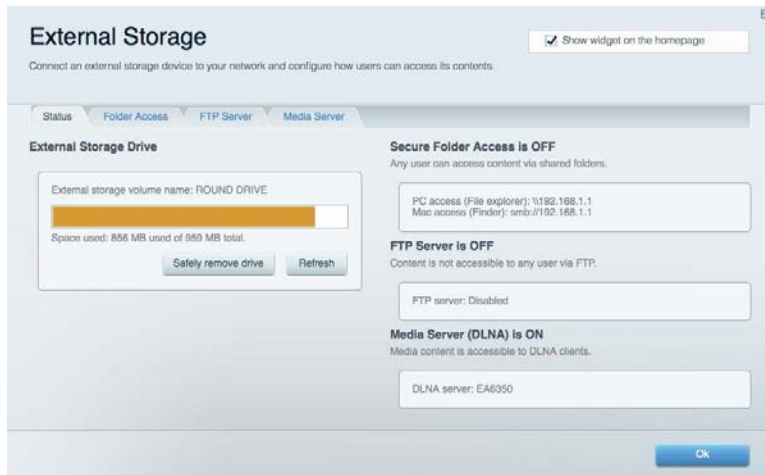

## Connectivité

Cela vous permet de consulter et de modifier les paramètres de base et avancés de votre réseau.

The screenshot shows the 'Connectivity' settings page. It has a title bar with a close button and a subtitle 'View and change router settings'. Below the title bar are tabs for 'Basic', 'Internet Settings', 'Local Network', 'Advanced Routing', 'VLAN', and 'Administration'. The 'Basic' tab is selected. The page is divided into several sections: 'Network Name and Password' with fields for 2.4 GHz and 5 GHz network names and passwords; 'Router Password' with a masked password field; 'Router Firmware Update' with a checked 'Automatic' checkbox and a 'Check for Updates' button; 'Time Zone' with a dropdown menu set to '(GMT-05:00) Eastern Time (USA & Canada)' and a checked 'Automatically adjust for Daylight Savings Time' checkbox; and 'Activity Lights' with an 'ON' toggle and a text box explaining the power light status. At the bottom, there are 'Ok', 'Cancel', and 'Apply' buttons.

## Dépannage

Cela vous permet de diagnostiquer les problèmes rencontrés avec votre routeur et de vérifier l'état de votre réseau.

The screenshot shows the 'Troubleshooting' page. It has a title bar with a close button and a subtitle 'Troubleshoot router settings'. Below the title bar are tabs for 'Status', 'Diagnostics', and 'Logs'. The 'Diagnostics' tab is selected. The page is divided into several sections: 'Ping IPv4' with input fields for IP or host name and number to ping, and a 'Start to Ping' button; 'Trace route' with an input field for IP or host name and a 'Start to Traceroute' button; 'Reboot' with a 'Reboot the router' link; 'Router configuration' with 'Backup' and 'Restore' buttons; 'Router Firmware' with a 'Restore previous firmware' button; 'Internet Address' showing IPv4 and IPv6 addresses with 'Release and Renew' links; and 'Factory reset' with a 'Reset to factory default settings' link. At the bottom, there is an 'Ok' button.

## Sans-fil

Cela vous permet de consulter et de modifier le réseau sans-fil de votre routeur. Vous pouvez modifier le nom du réseau, le mode de sécurité, le mot de passe, le filtre MAC et connecter les périphériques à l'aide de Wi-Fi Protected Setup.

The screenshot shows the 'Wireless' settings page. At the top, there is a checkbox for 'Show widget on the homepage' which is checked. Below this, there are tabs for 'Wireless', 'MAC Filtering', and 'Wi-Fi Protected Setup'. The 'Smart Connect' section has two radio buttons: '5 GHz band steering' (selected) and 'Off'. Below this, there are two network configuration sections. The first is for the 2.4 GHz network, with the name 'arachnid', password 'peterparker', and security mode 'WPA2/WPA Mixed'. The second is for the 5 GHz network, with the name 'arachnid\_5GHz', password 'peterparker', and security mode 'WPA2/WPA Mixed'. At the bottom, there are 'Ok', 'Cancel', and 'Apply' buttons.

## Sécurité

Cela vous permet de consulter et de modifier la sécurité du réseau sans-fil de votre routeur. Vous pouvez définir un pare-feu ou des paramètres de réseau privé virtuel (RPV, ou VPN en anglais), ou encore personnaliser des paramètres pour les applications et les jeux.

The screenshot shows the 'Security' settings page. At the top, there are tabs for 'Firewall', 'DMZ', and 'Apps and Gaming'. The 'Firewall' section has two checkboxes for 'IPv4 SPI firewall protection' and 'IPv6 SPI firewall protection', both of which are checked. The 'VPN Passthrough' section has three checkboxes for 'IPSec Passthrough', 'PPTP Passthrough', and 'L2TP Passthrough', all of which are checked. The 'Internet filters' section has four checkboxes: 'Filter anonymous Internet requests' (checked), 'Filter multicast' (unchecked), 'Filter Internet NAT redirection' (unchecked), and 'Filter ident (Port 113)' (checked). At the bottom, there is a table for 'IPv6 Port Services' with columns for 'Description', 'Protocol', 'IPv6 Address', 'Allow', and 'Enabled'. Below the table is a button labeled 'Add IPv6 Firewall Setting'. At the bottom of the page, there are 'Ok', 'Cancel', and 'Apply' buttons.



# Dépannage

Pour obtenir de l'aide supplémentaire, communiquez avec notre soutien à la clientèle primé sur [linksys.com/support/EA8300](https://linksys.com/support/EA8300).

## Votre routeur n'a pas été configuré correctement

Si Sans-fil intelligent Linksys n'a pas terminé la configuration, vous pouvez essayer la manipulation suivante :

- Maintenez le bouton Reset (réinitialisation) enfoncé, en utilisant l'extrémité d'un trombone ou une broche, jusqu'à ce que le logo lumineux Linksys s'éteigne et que les indicateurs bleus MU-MIMO commencent à clignoter (environ 10 secondes). Installez de nouveau le routeur.

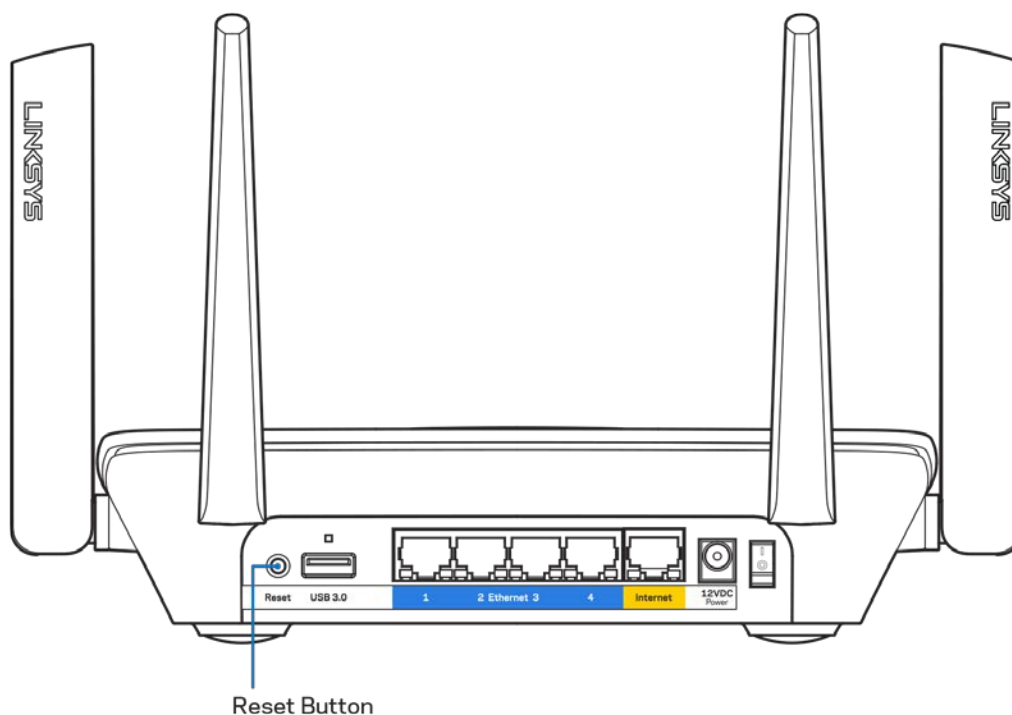

- Désactivez temporairement le pare-feu de votre ordinateur (pour obtenir de l'aide, reportez-vous aux instructions du logiciel de sécurité). Installez de nouveau le routeur.
- Si vous avez un autre ordinateur, utilisez-le pour installer de nouveau le routeur.

## Message *Votre câble Internet n'est pas branché*

Si le message « Votre câble Internet n'est pas branché » apparaît lorsque vous êtes en train de configurer votre routeur, suivez ces étapes de dépannage.

- Vérifiez qu'un câble Ethernet ou Internet (ou un câble comme celui fourni avec votre routeur) est bien branché au port Internet jaune à l'arrière de votre routeur et au port approprié sur votre modem. Ce port du modem est généralement étiqueté Ethernet.

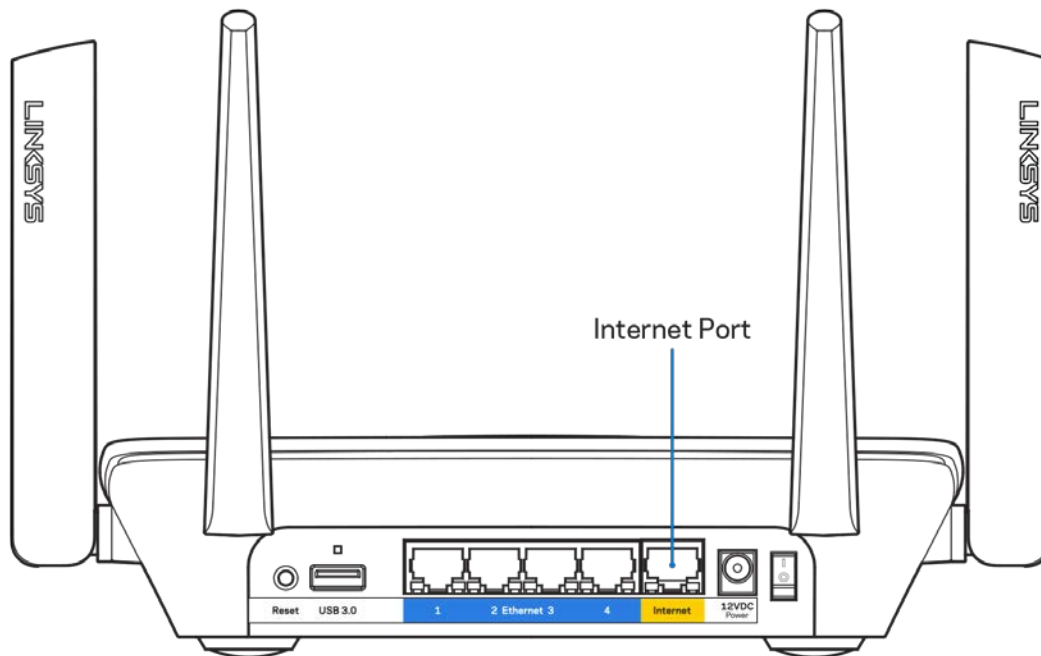

- Vérifiez que votre modem est branché à une source d'alimentation et qu'il est sous tension. S'il est doté d'un commutateur marche/arrêt, assurez-vous qu'il est réglé sur la position ON ou | (et non sur la position O).

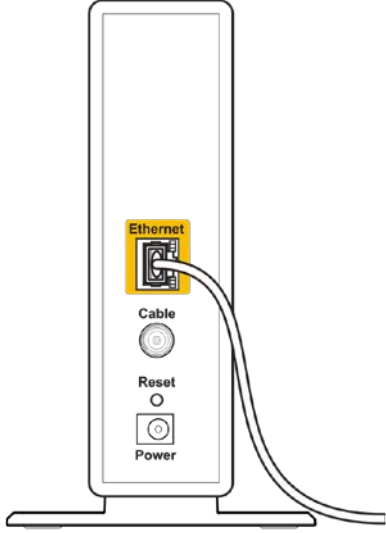
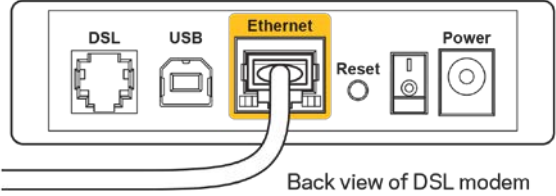
 <p style="text-align: center;">Back view of cable modem</p>	 <p style="text-align: center;">Back view of DSL modem</p>
<p>Si vous avez un accès Internet par le câble, vérifiez que le port CÂBLE du modem-câble est raccordé au câble coaxial fourni par votre FAI.</p>	<p>Si vous avez un accès Internet DSL, assurez-vous que la ligne téléphonique DSL est raccordée au port DSL du modem.</p>

- Si votre ordinateur était connecté à votre modem par un câble USB, déconnectez le câble USB.
- Installez de nouveau le routeur.

## Message *Impossible d'accéder à votre routeur*

Pour accéder à votre routeur, vous devez être connecté à votre propre réseau. Si vous disposez d'un accès Internet sans-fil, vous vous êtes peut-être connecté accidentellement à un autre réseau sans-fil.

Pour régler le problème sur les ordinateurs sous Windows, suivez les instructions suivantes\* :

1. Cliquez sur l'icône sans-fil de la barre d'état système. Une liste des réseaux disponibles s'affiche.

2. Cliquez sur le nom de votre propre réseau. Cliquez sur Connexion. Dans l'exemple ci-dessous, l'ordinateur était connecté à un autre réseau sans fil appelé wraith\_5GHz. Le nom du réseau sans fil du routeur EA8300 Linksys, Damaged\_Beez2.4 dans cet exemple, est sélectionné.



3. Si vous êtes invité à saisir une clé de sécurité réseau, entrez votre mot de passe (clé de sécurité) dans le champ Network security key (Clé de sécurité réseau). Cliquez sur **OK**.
4. Votre ordinateur se connectera au réseau et vous devriez pouvoir accéder au routeur.

*\*Selon la version Windows que vous utilisez, la description ou les icônes représentant ces étapes pourraient être légèrement différentes.*

Pour corriger le problème sur les ordinateurs Mac, faites ce qui suit :

1. Dans la barre de menu en haut de l'écran, cliquez sur l'icône du sans-fil. Une liste des réseaux sans fil apparaîtra.
2. Dans l'exemple ci-dessous, l'ordinateur était connecté à un autre réseau sans fil appelé wraith\_5GHz. Le nom du réseau sans fil du routeur EA8300 Linksys, Damaged\_Beez2.4 dans cet exemple, est sélectionné.

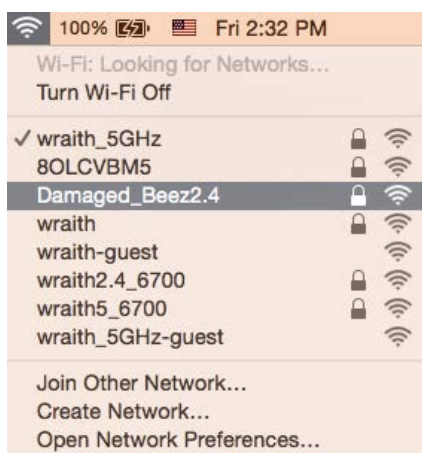

3. Cliquez sur le nom de réseau sans-fil du routeur EA8300 Linksys (Damaged\_Beez2.4 dans l'exemple).
4. Entrez votre mot de passe de réseau sans fil (Clé de sécurité) dans le champ *Password* (Mot de passe). Cliquez sur **OK**.

## Une fois la configuration terminée

### Internet ne semble pas disponible

Si Internet a de la difficulté à communiquer avec votre routeur, le problème pourrait apparaître sous forme de message « [adresse Internet] introuvable » dans votre navigateur Web. Si vous savez que l'adresse Internet est correcte, et que vous avez essayé plusieurs adresses Internet valides avec le même résultat, cela pourrait indiquer que votre FAI ou votre modem ne peut pas communiquer avec votre routeur. Essayez ce qui suit :

- Assurez-vous que les câbles réseau et d'alimentation sont correctement branchés.
- Assurez-vous que la prise de courant sur laquelle votre routeur est branché est alimentée en courant.
- Redémarrez le routeur.
- Communiquez avec votre FAI pour savoir s'il y a des pannes dans votre secteur.

La méthode la plus courante pour faire le dépannage de votre routeur est de l'éteindre, puis de le rallumer. Votre routeur peut alors recharger ses paramètres personnalisés, ce qui permettra aux autres périphériques (comme le modem) de le redécouvrir et de communiquer avec lui. C'est ce qu'on appelle le « redémarrage ».

Pour redémarrer votre routeur en utilisant le cordon d'alimentation, faites ce qui suit :

1. Débranchez le cordon d'alimentation du routeur et du modem.
2. Attendez 10 secondes, puis rebranchez-le sur le modem. Assurez-vous qu'il est sous tension.
3. Attendez que le voyant « en ligne » du modem cesse de clignoter (environ deux minutes). Rebranchez le cordon d'alimentation sur le routeur.
4. Patientez jusqu'à ce que le logo lumineux Linksys soit allumé. Patientez deux minutes avant d'essayer de vous connecter à Internet à partir d'un ordinateur.

Pour redémarrer votre routeur en utilisant le Sans-fil intelligent Linksys, faites ce qui suit :

1. Connectez-vous au Sans-fil intelligent Linksys. (Voir « Connexion à Sans-fil intelligent Linksys » à la page [11](#).)
2. Sous *Router Settings* (Paramètres du routeur), cliquez sur *Troubleshooting* (Dépannage).
3. Cliquez sur l'onglet *Diagnostics* (Diagnostic).
4. Sous *Reboot* (Redémarrer), cliquez sur *Reboot* (Redémarrer).



5. Cliquez sur **Yes** (Oui). Le routeur va redémarrer. Pendant cette opération, tous les périphériques qui y sont raccordés perdront leur connexion Internet et se reconnecteront automatiquement lorsque le routeur sera de nouveau prêt.

**Le Sans-fil intelligent Linksys ne s'ouvre pas dans votre navigateur Web**  
Les versions les plus récentes de Google Chrome™, Firefox®, Safari® (pour Mac® et iPad®), Microsoft Edge, et les versions 8 et suivantes d'Internet Explorer® sont compatibles avec Sans-fil intelligent Linksys.

# Caractéristiques techniques

## Linksys EA8300

Nom du modèle	Routeur tribande MU-MIMO AC2200 Max-Stream
Numéro du modèle	EA8300
Vitesse du port du commutateur	10/100/1000 Mbit/s (Gigabit Ethernet)
Fréquence radio	2,4 GHz et 5 GHz (x2)
Nombre d'antennes	4 antennes externes réglables (non amovibles)
Ports	USB 3.0, Ethernet (1-4), Internet, Alimentation
Boutons	Wi-Fi Protected Setup, marche/arrêt, Reset (réinitialisation)
Voyants	<b>Panneau supérieur :</b> Logo Linksys lumineux , Wi-Fi Protected Setup, Connexion Internet, Connexion du câble réseau au port Internet <b>Panneau arrière :</b> USB, Ethernet (1-4), Internet
UPnP	Pris en charge
Fonctions de sécurité	WEP, WPA2, RADIUS
Bits de clé de sécurité	Cryptage de données jusqu'à 128 bits
Systèmes d'allocation de fichiers de l'unité de stockage	FAT, NTFS et HFS+
Navigateurs compatibles	Les versions les plus récentes de Google Chrome™, Firefox®, Safari® (pour Mac® et iPad®), Microsoft Edge, et les versions 8 et suivantes d'Internet Explorer.

## Environnement d'exploitation

Dimensions	213,7 mm x 161,8 mm x 54,8 mm (sans les antennes)
Poids unitaire	608 g
Alimentation	12 V, 2 A
Certifications	FCC, IC, CE, Wi-Fi (a/b/g/n/ac)
Température de fonctionnement :	0 à 40 °C (32 à 104 °F)
Température de stockage :	-20 à 60 °C (-4 à 140 °F)
Humidité (marche)	10 % à 80 % d'humidité relative, sans condensation
Humidité (entreposage)	5 % à 90 %, sans condensation

Les spécifications peuvent changer sans préavis.

Remarques :

Pour en savoir plus à propos de la conformité aux normes, la garantie et la sécurité, consultez le CD fourni avec votre routeur ou rendez-vous sur [Linksys.com/support/EA8300](http://Linksys.com/support/EA8300).

Les performances maximales sont conformes à la norme IEEE 802.11. Les performances réelles peuvent varier, notamment une capacité de réseau sans fil, un taux de débit de données et une portée moindres. La performance dépend de nombreux facteurs, conditions et variables, dont l'éloignement du point d'accès, le volume du trafic réseau, les matériaux et la construction de l'édifice, le système d'exploitation utilisé, la combinaison des produits sans fil utilisés, les interférences ainsi que d'autres conditions défavorables.

BELKIN, LINKSYS et de nombreux noms de produits et logos sont des marques de commerce du groupe de sociétés Belkin. Les autres marques mentionnées sont la propriété de leur détenteur respectif. Les licences et la documentation relatives aux logiciels tiers utilisés dans ce produit peuvent être consultées à l'adresse suivante : <http://support.linksys.com/en-us/license>. Pour toute demande relative au code source LPG ou toute autre question, veuillez communiquer avec nous à l'adresse <http://support.linksys.com/en-us/gplcodecenter>.

© Belkin International, Inc. ou ses sociétés affiliées, 2017. Tous droits réservés.



**LINKSYS®**

دليل المستخدم

موجه **TM**MAX-STREAM  
AC2200 MU-MIMO  
ثلاثي النطاق

الطراز EA8300

## المحتويات

### 3 نظرة عامة على المنتج

- 3 عرض الجزء العلوي
- 4 مؤشر حالة النظام
- 5 منظر خلفي
- 6 منظر جانبي

### 7 الإعداد: الأساسيات

- 7 مكان العثور على المزيد من التعليمات
- 8 كيفية تركيب الموجّه

### 10 كيفية استخدام Fi-Linksys Smart Wi

- 10 كيفية التوصيل بـ Fi-Linksys Smart Wi
- 11 مخطط الشبكة
- 11 وصول الضيوف
- 12 التحكم الأبوي
- 12 تحديد أولوية الوسائط
- 13 اختبار السرعة
- 13 التخزين الخارجي
- 14 الاتصال
- 14 استكشاف الأخطاء وإصلاحها
- 15 لاسلكي
- 15 الأمان

### 16 استكشاف الأخطاء وإصلاحها

- 16 لم يتم إعداد الموجّه بنجاح
- 17 رسالة "كبل الإنترنت غير متصل"
- 18 رسالة *Cannot access your router* (تعذر الوصول إلى الموجّه)
- 19 بعد الإعداد
- 19 يظهر الإنترنت كغير متوفر
- 20 Fi-Linksys Smart Wi لا يفتح في مستعرض الويب

### 21 المواصفات

- 21 Linksys EA8300
- 21 المعطيات البيئية

نظرة عامة على المنتج  
عرض الجزء العلوي

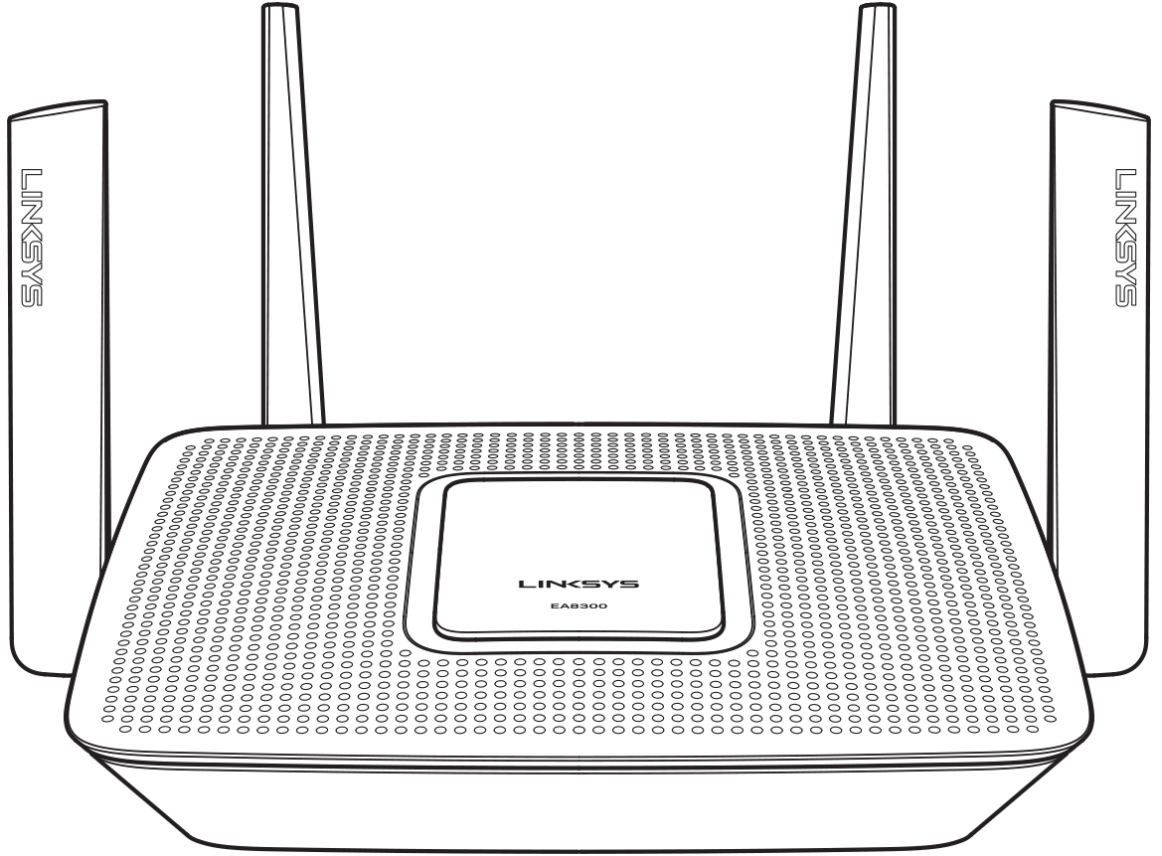

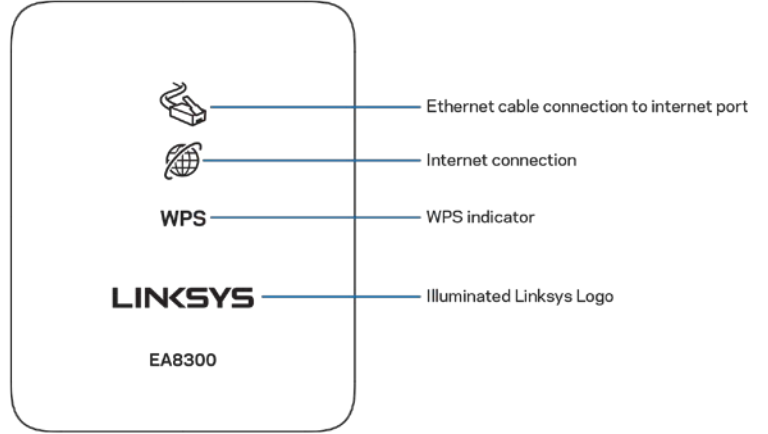

اتصال كبل Ethernet بمنفذ الإنترنت—عندما يضيء (باللون البرتقالي)، فهذا يشير إلى وجود مشكلة في كبل الشبكة المتصل بمنفذ الإنترنت (WAN).  
 اتصال إنترنت—عندما يضيء (باللون البرتقالي)، فهذا يشير إلى عدم تمكن الموجه من الوصول إلى الإنترنت.  
 مؤشر WPS (Wi-Fi Protected Setup)™ —لضوء WPS أربع حالات:

توقف نشاط Wi-Fi Protected Setup	إيقاف تشغيل
Wi-Fi Protected Setup قيد التقدم	أبيض وامض
نجاح Wi-Fi Protected Setup؛ يبقى مضيئاً لمدة خمس ثوانٍ	أبيض ثابت
خطأ في Wi-Fi Protected Setup؛ يومض لمدة دقيقة واحدة ثم يتوقف.	برتقالي وامض

شعار Linksys مضيء—يومض الشعاع أثناء بدء تشغيل الموجه. عندما يضيء الشعاع باللون الأبيض الثابت، فهذا يعني تشغيل الموجه وأنه يعمل على النحو الصحيح.

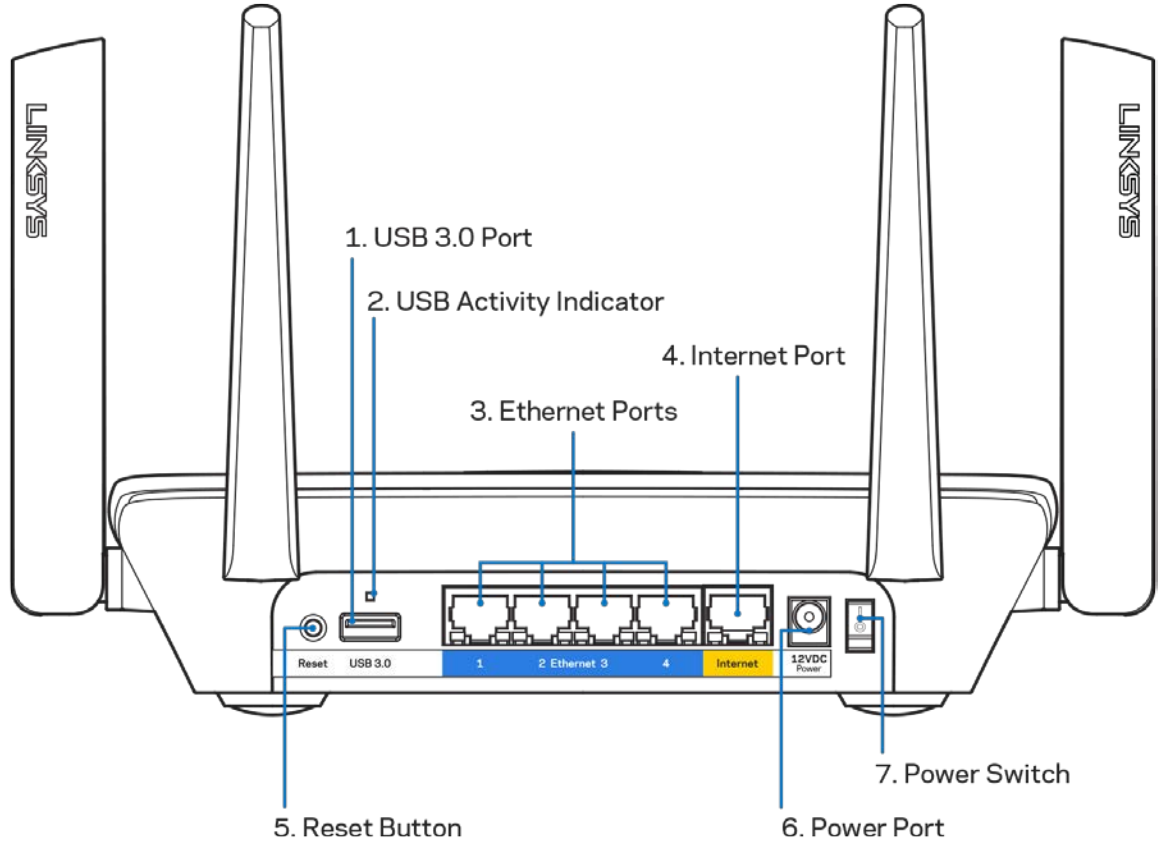

منفذ USB 3.0—قم بتوصيل ومشاركة محركات أقراص USB عبر شبكتك أو عبر الإنترنت.

مؤشر نشاط USB—أضواء تشير إلى نقل البيانات من /إلى الأجهزة الخارجية.

منافذ Ethernet (3) —قم بتوصيل كابلات Ethernet بمنافذ gigabit (1000/100/10) زرقاء اللون، وبأجهزة سلكية على شبكتك.

ملاحظة - للحصول على أفضل أداء، استخدم كبلات ذات تصنيف CAT5e أو أعلى على منافذ Ethernet.

منفذ الإنترنت (4) —قم بتوصيل كبل ethernet بمنفذ gigabit (1000/100/10) الأصفر هذا، وكبل إنترنت ذي نطاق ترددي واسع/DSL أو بمودم ألياف.

ملاحظة - للحصول على أفضل أداء، استخدم كبلًا ذا تصنيف CAT5e أو أعلى على منافذ Ethernet.

زر إعادة الضبط (5) —اضغط عليه مع الاستمرار حتى يتوقف ضوء شعار Linksys لإعادة ضبط الموجه إلى إعدادات المصنع. يمكنك أيضًا استعادة إعدادات المصنع باستخدام Linksys Smart Wi-Fi على الإنترنت أو تطبيق المحمول.

منفذ الطاقة (6) - قم بتوصيل محول طاقة التيار المتردد.

مفتاح الطاقة (7) - اضغط على | (تشغيل) لتشغيل الموجه.

## منظر جانبي

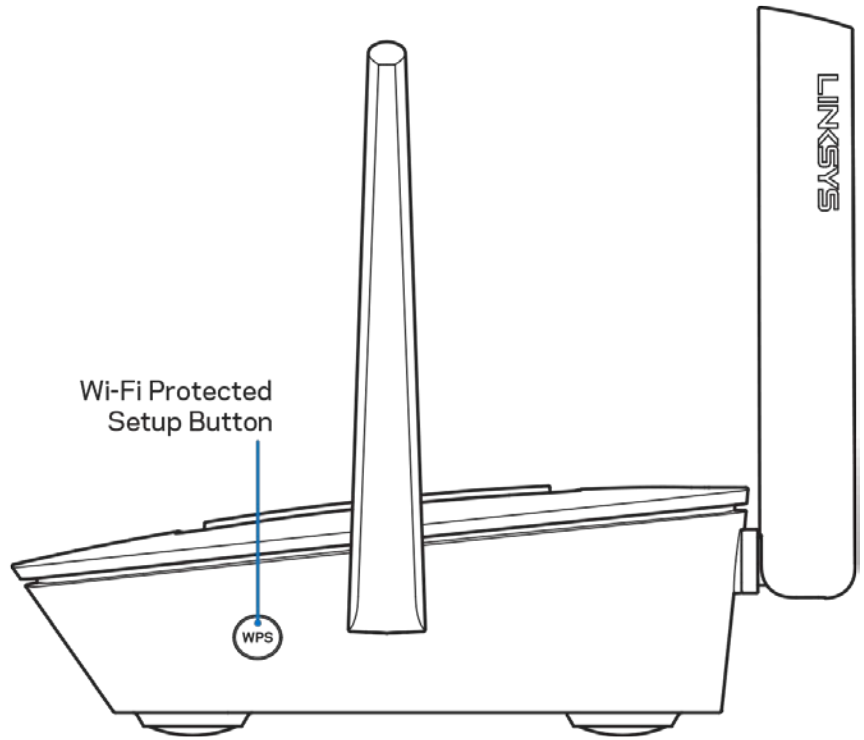

زر Wi-Fi Protected Setup™ — اضغط لتوصيل أجهزة الشبكة الممكن عليها WPS.

# الإعداد: الأساسيات

## مكان العثور على المزيد من التعليمات

بالإضافة إلى دليل المستخدم هذا، يمكنك العثور على مساعدة في الأماكن التالية:

- [Linksys.com/support/EA8300](http://support.linksys.com/EA8300) (وثائق وتنزيلات وأسئلة متداولة ودعم فني ودرشة مباشرة ومندوبات)
- مساعدة Linksys Smart Wi-Fi (اتصل بـ Linksys Smart Wi-Fi، ثم انقر فوق Help (مساعدة) أعلى الشاشة)

The screenshot shows the Linksys Smart Wi-Fi web interface. The top navigation bar includes 'App Center', 'Help' (highlighted with a red circle), 'Linksys15895', and 'Christopher K.'. The main content area is divided into two columns. The left column contains a sidebar with 'Smart Wi-Fi Tools' (Network Map, Guest Access, Parental Controls, Media Prioritization, Speed Test, External Storage) and 'Router Settings' (Connectivity, Troubleshooting, Wireless, Security). The right column displays several widgets: 'Network Status' (Connected), 'Linksys Home Networking' (Performance Perfected), 'Wireless' (Linksys15895, 2.4 GHz, Linksys15895\_5GHz, 5 GHz), 'Guest Access' (Guest Network is ON), 'Network Map' (Online devices: Local 1), 'Parental Controls' (Parental Controls are OFF), 'External Storage' (There is no drive in the external port), and 'Media Prioritization' (Media Prioritization is Off). Below the main content is a 'Help' section with the title 'Using Linksys Smart Wi-Fi'. The text explains that Linksys Smart Wi-Fi allows access to all router features and settings. It lists three key features: 1. See what's currently connected to your network, and connect more computers and devices. 2. Create a Linksys Smart Wi-Fi account to access router settings from anywhere using any browser, even when you're away from home. 3. Allow guests in your home to use the Internet without giving them access to your network. A 'Help Categories' sidebar on the right lists: Linksys Smart Wi-Fi, Device List, Guest Access, Parental Controls, Media Prioritization, Speed Test, External Storage, and Connectivity. An 'Ok' button is at the bottom right.

ملاحظة - التراخيص والإشعارات الخاصة ببرامج الأطراف الثالثة المستخدمة في هذا المنتج قد تعرض على

<http://support.linksys.com/en-us/license>. يرجى الاتصال بـ <http://support.linksys.com/en-us/gplcodecenter> لأي استفسارات أو طلبات التعليمات البرمجية المصدر طبقاً لرخصة جنو العمومية (GPL).

## كيفية تركيب الموجّه

1. لاستكمال الإعداد، يلزم توفر جهاز كمبيوتر للتمكن من زيارة <http://LinksysSmartWiFi.com> من مستعرض ويب.
2. حدد ما يلزمك من تجهيزات.

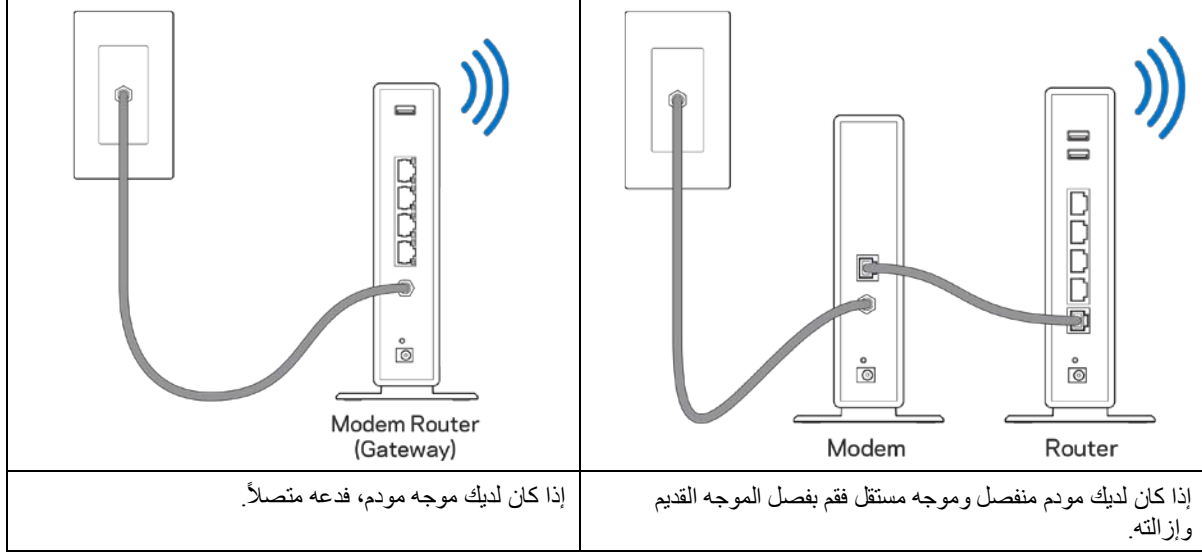

3. قم بضبط الهوائيات في وضع منتصب مع توصيل الموجّه بمصدر طاقة. تأكد من أن مفتاح الطاقة في الوضع | (تشغيل).
4. قم بتوصيل الموجّه بالمودم أو بالمودم-الموجّه. وصل أحد طرفي كابل الإنترنت بمنفذ الإنترنت أصفر اللون في الموجّه الجديد. إذا كان لديك مودم فوصل الطرف الآخر بمنفذ (Ethernet LAN) في المودم. إذا كان لديك موجّه مودم، فوصل الطرف بأي منفذ متاح.
5. انتظر حتى يتوقف شعار Linksys الموجود أعلى الموجّه عن الوميض ويصبح لونه أبيض ثابتاً.
6. قم بالتوصيل باسم Wi-Fi المعروف في دليل البدء السريع المرفق بالموجّه. (يمكنك تغيير هذه التفاصيل لاحقاً). إذا كنت بحاجة لمساعدة في الاتصال بالشبكة، فراجع وثائق الجهاز الموجودة على [linksys.com/support/EA8300](http://linksys.com/support/EA8300).

ملاحظة—لن تتوفر لديك إمكانية وصول للإنترنت قبل اكتمال إعداد الموجّه.

7. أدخل <http://LinksysSmartWiFi.com> في مستعرض ويب. اتبع التعليمات التي تظهر على الشاشة لإكمال إعداد الموجّه. يمكنك أيضاً كتابة 192.168.1.1 في مستعرض لبدء الإعداد.

في نهاية الإعداد، اتبع التعليمات التي تظهر على الشاشة لإعداد حساب Linksys Smart Wi-Fi. استخدم Linksys Smart Wi-Fi لتكوين الموجّه من أي كمبيوتر به اتصال بالإنترنت.

إدارة إعدادات الموجّه:

- تغيير اسم الموجّه وكلمة المرور
- إعداد وصول الضيوف
- تكوين التحكم الأبوي
- توصيل الأجهزة بشبكة Wi-Fi
- اختبار سرعة اتصالك بالإنترنت

ملاحظة—كجزء من عملية إعداد حساب Linksys Smart Wi-Fi، سيتم إرسال رسالة بريد إلكتروني للتحقق إليك. من شبكة المنزل، انقر فوق الارتباط الموجود في رسالة البريد الإلكتروني لإقران الموجّه بحساب Linksys Smart Wi-Fi.

تلميح - اطبع الصفحة التالية، ثم سجّل إعدادات الموجّه والحساب في الجدول أدناه كمرجع. خزّن ملاحظتك في مكان آمن.



	اسم Wi-Fi 2.4 جيجا هرتز
	كلمة مرور Wi-Fi
	اسم شبكة Wi-Fi 5 جيجا هرتز 1
	كلمة مرور Wi-Fi
	5 جيجا هرتز 2 اسم Wi-Fi
	كلمة مرور Wi-Fi
	كلمة مرور الموجه
	اسم شبكة Wi-Fi للضيوف 2.4 جيجا هرتز
	اسم شبكة Wi-Fi للضيوف 5 جيجا هرتز
	كلمة مرور شبكة Wi-Fi للضيوف (كلاهما يتشارك كلمة مرور)
	اسم مستخدم Linksys Smart Wi-Fi
	كلمة مرور Linksys Smart Wi-Fi

# كيفية استخدام Linksys Smart Wi-Fi

يمكنك إدارة الموجه من أي مكان في العالم باستخدام Linksys Smart Wi-Fi، لكن يمكنك أيضًا فعل ذلك مباشرة من الشبكة المنزلية لديك. قد يتوفر Linksys Smart Wi-Fi لجهازك المحمول أيضًا. راجع متجر تطبيقات جهازك للحصول على معلومات.

## كيفية التوصليل بـ Linksys Smart Wi-Fi

للتوصليل بـ Linksys Smart Wi-Fi:

1. افتح مستعرض الويب الموجود على الكمبيوتر.
2. انتقل إلى <http://LinksysSmartWiFi.com> وسجل دخولك إلى حسابك.

### Linksys Smart Wi-Fi Sign In

If you have not yet created a Linksys Smart Wi-Fi account, click the 'Create Account' button in the upper right corner of the page.



Give guests Internet access

Remember Me  
Forgot your password?  
  
Don't have an account? [Click here.](#)

English (United States)

For local access, [click here.](#)

Use your Linksys Smart Wi-Fi account to access your home network from anywhere, at any time, even from your mobile device. Easily connect new devices, set parental controls, get access to Smart Wi-Fi mobile Apps, and more.  
For more information [click here](#)

إذا لم تكن تتذكر كلمة المرور الخاصة بك، فانقر فوق *هل نسيت كلمة مرورك؟* واتبع الإرشادات التي تظهر على الشاشة لاستردادها.

## مخطط الشبكة

تتيح لك عرض جميع أجهزة الشبكة المتصلة بالموجه. يمكنك عرض الأجهزة على شبكتك الرئيسية وشبكة الضيوف، أو عرض معلومات حول كل جهاز.



## وصول الضيوف

دعنا نقوم بإعداد الشبكة ومراقبتها حتى يتمكن الضيوف من الوصول إلى شبكة Wi-Fi دون التعرض إلى المعلومات الشخصية.

The Guest Access configuration interface shows a central router labeled 'SparrowHawk'. It is connected to several devices, each with its own icon and name: 'iPad' (5 GHz), 'The beast' (laptop), 'Jen's laptop' (2.4 GHz), 'Smart TV' (5 GHz), 'Kim's phone' (5 GHz), 'Dad's phone' (5 GHz), 'Kitchen lamp' (2.4 GHz), and 'Puppies' (5 GHz). The interface includes a 'Filter map' dropdown, a '+ Add a Device' button, and a 'Show widget on the homepage' checkbox. The title 'Network Map' is at the top, and an 'OK' button is at the bottom right.

## التحكّم الأبوي

يُتيح لك حظر مواقع ويب وتعيين أوقات الوصول إلى الإنترنت.

### Parental Controls

Limit when your children get online and what websites they can see.

Show widget on the homepage

**Enable parental controls**

OFF

**Restrict Internet access on**

Christopher's MacBook Air
CMK's Galaxy S5
ChristohersIPad
ODK's Kindle Fire
ODKs-iPod
TTKs-iPad

**Block Internet access**

Never  
 Always  
 Specific Times

**Block specific sites**

www.blockedsite.com Enter a website to block

Ok Cancel

## تحديد أولوية الوسائط

يُتيح لك تعيين الأجهزة والتطبيقات التي لها أعلى أولوية لنسبة استخدام الشبكة.

### Media Prioritization

Give priority to those devices, applications, and games that connect to streaming or real-time media services for best performance on your home network.

Show widget on the homepage

**Prioritization:**  ON [Reset Prioritization](#) | [Settings](#)

**High Priority**

Drag and drop devices to prioritize

**Normal Priority**

**Devices**

Christopher's MacB...	CMK's Galaxy S5
ChristohersIPad	ODK's Kindle Fire
ODKs-iPod	TTKs-iPad

**Applications** Edit | Delete

Skype

**Online Games** Edit | Delete

City of Heroes / Villans

Ok Cancel

## اختبار السرعة

يُتيح لك اختبار سرعة الاتصال بالإنترنت في شبكتك.



## التخزين الخارجي

يُتيح لك الوصول إلى محرك أقراص USB (غير مرفق) متصل وإعداد مشاركة الملفات وخدمات الوسائط والوصول إلى FTP.

The image shows the 'External Storage' configuration interface. It includes a 'Show widget on the homepage' checkbox, a 'Status' tab, and sections for 'External Storage Drive', 'Secure Folder Access', 'FTP Server', and 'Media Server (DLNA)'. The 'External Storage Drive' section shows the volume name 'ROUND DRIVE' and a progress bar. The 'Secure Folder Access' section is currently 'OFF'. The 'FTP Server' section is 'OFF'. The 'Media Server (DLNA)' section is 'ON'.

Section	Status
Secure Folder Access	OFF
FTP Server	OFF
Media Server (DLNA)	ON

## الاتصال

يُتيح لك عرض إعدادات الشبكة الأساسية والمتقدمة وتغييرها.

### Connectivity

View and change router settings

Basic Internet Settings Local Network Advanced Routing VLAN Administration

**Network Name and Password | Edit**

2.4 GHz network name: arachnid  
Network password: peterparker

5 GHz + 5 GHz network name: arachnid\_5GHz  
Network password: peterparker

**Router Password | Edit**

Router password: \*\*\*\*\*

**Router Firmware Update**

Automatic (Current Version: 1.1.5.164615)  
[Check for Updates](#)

**Time Zone**

(GMT-05:00) Eastern Time (USA & Canada) ▾  
 Automatically adjust for Daylight Savings Time

**Activity Lights**

ON  OFF  
Enable/disable activity lights. Power light will remain on.

[Ok](#) [Cancel](#) [Apply](#)

## استكشاف الأخطاء وإصلاحها

يُتيح لك تشخيص المشاكل ذات الصلة بالموجه وفحص حالة الشبكة.

### Troubleshooting

Troubleshoot router settings

Status Diagnostics Logs

**Ping IPv4**

IP or host name:   
Number to ping: 5 ▾  
[Start to Ping](#)

**Trace route**

IP or host name:   
[Start to Traceroute](#)

**Reboot**

[Reboot the router](#)

**Router configuration**

[Backup](#) [Restore](#)

**Router Firmware**

[Restore previous firmware](#)

**Internet Address:**

IPv4: 10.0.0.253 [Release and Renew](#)  
IPv6: 2601:0540::000:0019:0000:0000:0000:314e [Release and Renew](#)

**Factory reset**

[Reset to factory default settings](#)

[Ok](#)

## لاسلكي

يُتيح لك عرض الشبكة اللاسلكية للموجه وتغييرها. يمكنك تغيير أسماء الشبكة ووضع الأمان وكلمة المرور وتصفية عناوين MAC وتوصيل الأجهزة باستخدام Wi-Fi Protected Setup.

The screenshot shows the 'Wireless' settings page. At the top, there's a 'Show widget on the homepage' checkbox. Below it, there are tabs for 'Wireless', 'MAC Filtering', and 'Wi-Fi Protected Setup'. The 'Smart Connect' section has two radio buttons: '5 GHz band steering' (selected) and 'Off'. Below this, there are two network configuration sections. The first is for the 2.4 GHz band with network name 'arachnid', password 'peterparker', and various other settings. The second is for the 5 GHz band with network name 'arachnid\_5GHz' and similar settings. At the bottom, there are 'Ok', 'Cancel', and 'Apply' buttons.

## الأمان

يُتيح لك عرض الأمان اللاسلكي للموجه وتغييره. يمكنك إعداد جدار الحماية وإعدادات VPN بالإضافة إلى تعيين إعدادات مخصصة للتطبيقات والألعاب.

The screenshot shows the 'Security' settings page. It has tabs for 'Firewall', 'DMZ', and 'Apps and Gaming'. The 'Firewall' section has checkboxes for 'IPv4 SPI firewall protection' and 'IPv6 SPI firewall protection', both of which are checked. The 'Internet filters' section has checkboxes for 'Filter anonymous Internet requests', 'Filter multicast', 'Filter Internet NAT redirection', and 'Filter ident (Port 113)', with the first and last ones checked. The 'VPN Passthrough' section has checkboxes for 'IPSec Passthrough', 'PPTP Passthrough', and 'L2TP Passthrough', all of which are checked. At the bottom, there is a table for 'IPv6 Port Services' with columns for 'Description', 'Protocol', 'IPv6 Address', 'Allow', and 'Enabled'. Below the table is an 'Add IPv6 Firewall Setting' button. At the very bottom, there are 'Ok', 'Cancel', and 'Apply' buttons.

## استكشاف الأخطاء وإصلاحها

يمكنك العثور على مزيد من التعليمات من خلال دعم العملاء الحائز على جوائز على موقع [linksys.com/support/EA8300](http://linksys.com/support/EA8300).

### لم يتم إعداد الموجه بنجاح

إذا لم يكمل Linksys Smart Wi-Fi الإعداد، فيمكنك تجربة ما يلي:

- اضغط باستمرار على زر "إعادة الضبط" بالموجه لديك مستخدمًا لمشبك أو دبوس حتى يتوقف شعار Linksys المضيء عن التشغيل وتبدأ مؤشرات MU-MIMO الزرقاء في الوميض (حوالي 10 ثوانٍ). أعد تركيب الموجه.

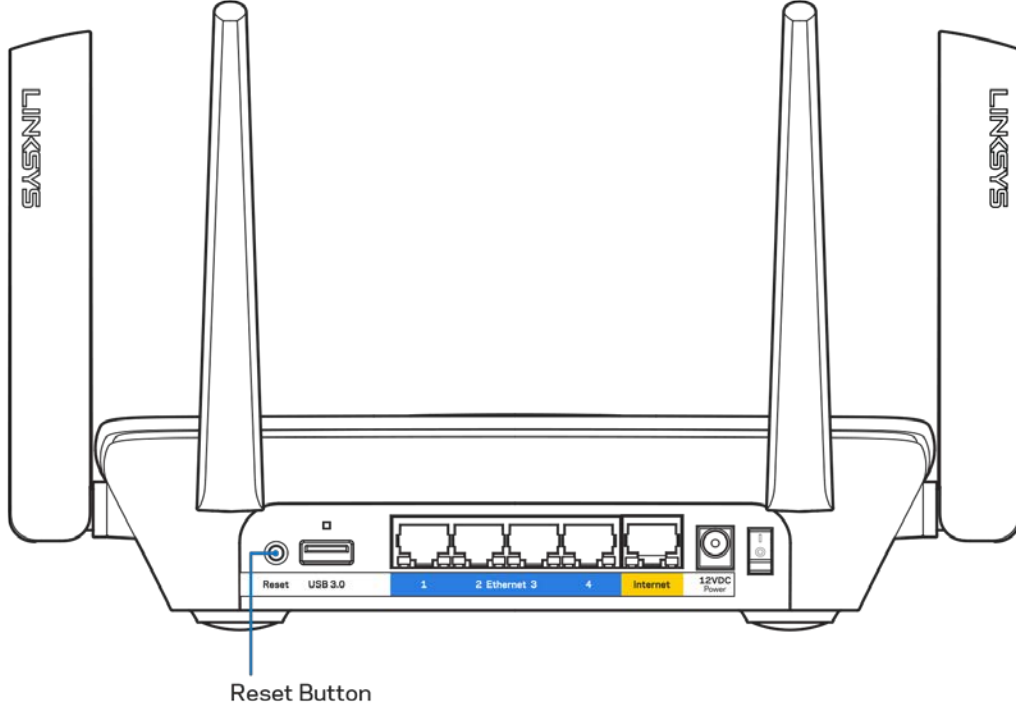

- قم بتعطيل جدار حماية الكمبيوتر مؤقتًا (راجع إرشادات برنامج الأمان للمساعدة). أعد تركيب الموجه.
- إذا كان لديك كمبيوتر آخر، فاستخدمه لتركيب الموجه مرة أخرى.



## رسالة "كبل الإنترنت غير متصل"

- في حالة ظهور الرسالة "كبل الإنترنت غير متصل" أثناء محاولة إعداد الموجه، اتبع خطوات استكشاف المشكلات وإصلاحها الواردة هنا.
- تأكد من توصيل كابل Ethernet أو الإنترنت (أو كابل كالمرفق مع الموجه) بإحكام بمنفذ الإنترنت الأصفر بالجزء الخلفي من الموجه وبالمنفذ الملائم في المودم. عادة ما يعرف هذا المنفذ بالمودم باسم Ethernet.

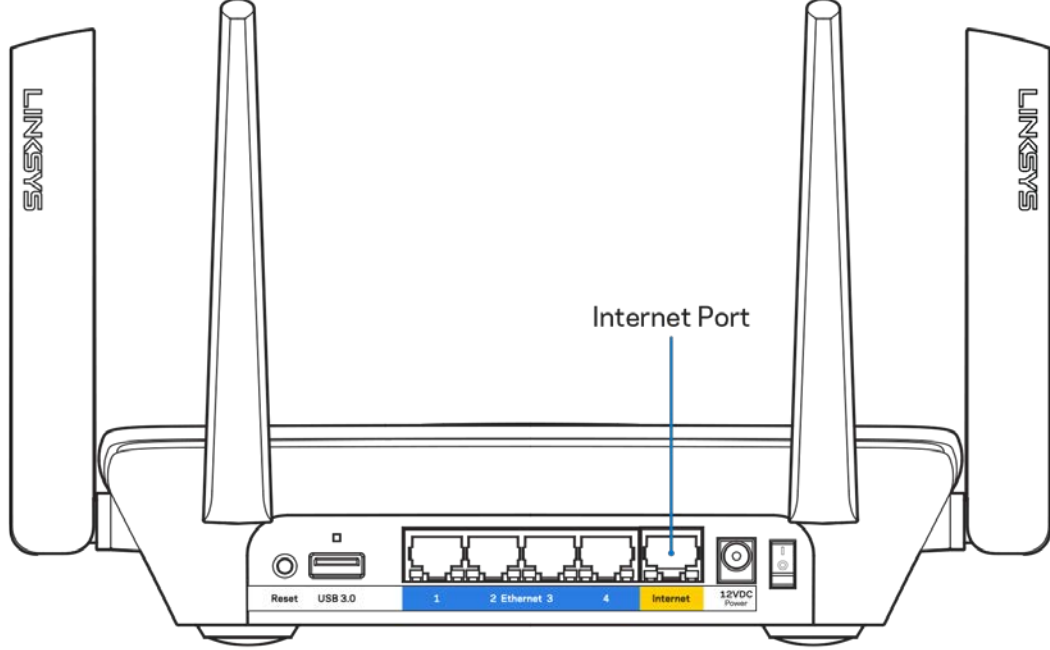

- تأكد من أن المودم متصل بالتيار وقيد التشغيل. وفي حالة احتوائه على مفتاح تيار، تأكد من تعيينه إلى موضع ON (تشغيل) أو | (وليس O).

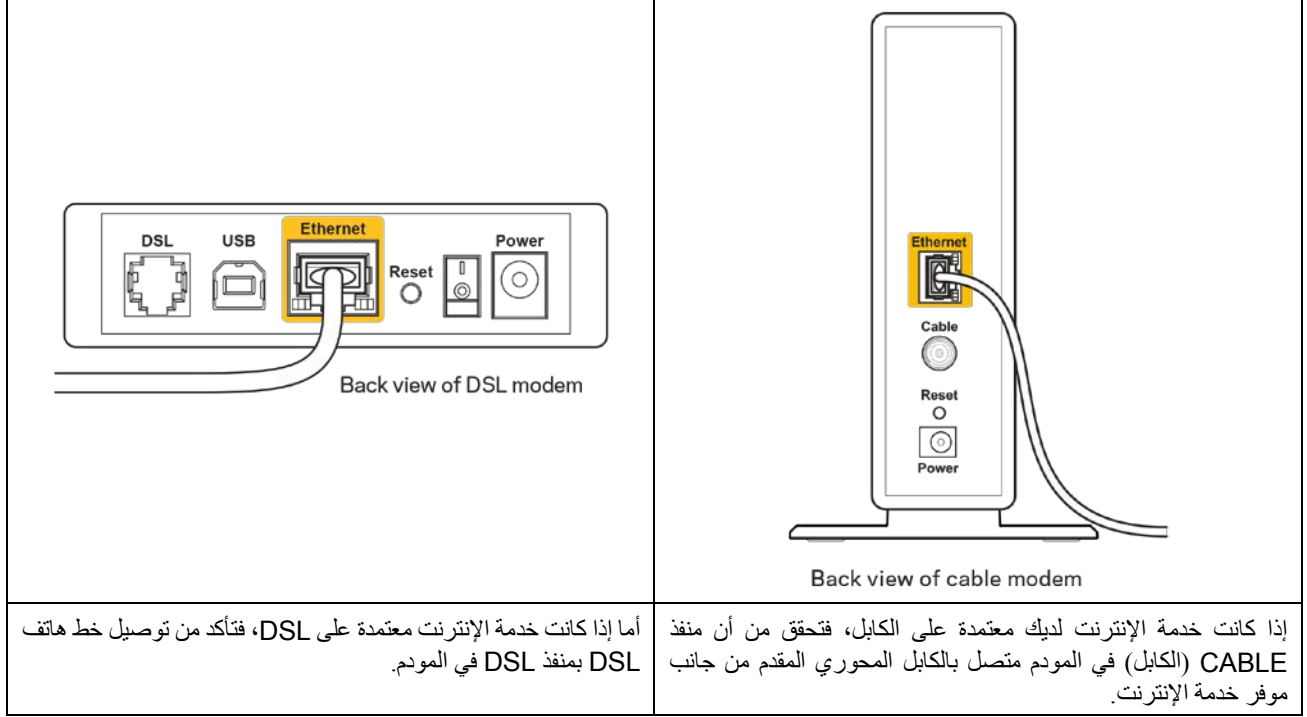

- إذا سبق توصيل الكمبيوتر الخاص بك بالمودم باستخدام كبل USB، فافصل كبل USB.
- أعد تركيب الموجه.

## رسالة *Cannot access your router* (تعذر الوصول إلى الموجه)

للوصول إلى الموجه، يجب أن تكون متصلاً بشبكتك. إذا توفر لديك وصول لإنترنت لاسلكي، فربما تكون المشكلة أنك اتصلت بشبكة لاسلكية مختلفة دون قصد.

لإصلاح المشكلة على أجهزة كمبيوتر بنظام Windows، قم بما يلي\*:

1. انقر فوق رمز الشبكة اللاسلكية في درج النظام. ستظهر قائمة بالشبكات المتوفرة.
2. انقر فوق اسم شبكتك. انقر فوق Connect (اتصال). في المثال أدناه، الكمبيوتر كان متصلاً بشبكة لاسلكية أخرى اسمها wraith\_5GHz. يتم عرض اسم الشبكة اللاسلكية لموجه Linksys EA8300، وهو Damaged\_Beez2.4 في هذا المثال، محدداً.



3. إذا طُلب منك إدخال مفتاح أمان الشبكة، فاكتب كلمة المرور (مفتاح الأمان) في حقل مفتاح أمان الشبكة. انقر فوق OK (موافق).
4. يتصل الكمبيوتر بالشبكة ويجب أن تتمكن من الوصول إلى الموجه.

\*حسب إصدار Windows المثبت لديك، قد توجد بعض الاختلافات في الألفاظ أو الأيقونات المُشار إليها بهذه الخطوات.

الإصلاح المشكلة على أجهزة كمبيوتر بنظام Mac، قم بما يلي:

1. في شريط القائمة عبر الجزء العلوي من الشاشة، انقر فوق أيقونة Wi-Fi. ستظهر قائمة بالشبكات اللاسلكية المتوفرة.
2. في المثال أدناه، الكمبيوتر كان متصلاً بشبكة لاسلكية أخرى اسمها wraith\_5GHz. يتم عرض اسم الشبكة اللاسلكية لموجه Linksys EA8300، وهو Damaged\_Beez2.4 في هذا المثال، محدداً.

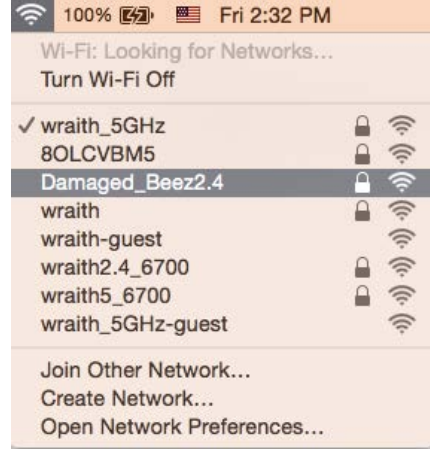

3. انقر فوق اسم الشبكة اللاسلكية لموجه Linksys EA8300 (وهو Damaged\_Beez2.4 في هذا المثال).
4. اكتب كلمة مرور الشبكة اللاسلكية (مفتاح الأمان) في حقل كلمة المرور. انقر فوق "موافق".

## بعد الإعداد

### يظهر الإنترنت كغير متوفر

إذا كانت هناك صعوبة في اتصال الإنترنت بالموجه، فقد تظهر المشكلة كرسالة "تعذر العثور على [عنوان الإنترنت]" في مستعرض الويب. إذا كنت على يقين بصحة عنوان الإنترنت، وقد جربت عدة عناوين إنترنت صالحة وظهرت لك النتيجة نفسها، فقد تعني الرسالة وجود مشكلة لدى موفر خدمة الإنترنت أو المودم المتصل بالموجه. حاول القيام بما يلي:

- تأكد من توصيل كبلي الشبكة والتيار بأمان.
  - تأكد من أن مأخذ التيار المتصل به الموجه به تيار ساكن.
  - أعد تشغيل الموجه.
  - اتصل بموفر خدمة الإنترنت وتحقق من وجود انقطاعات في منطقتك.
- يعد إيقاف تشغيل الموجه ثم إعادة تشغيله أشهر طريقة لاستكشاف مشكلة الموجه وإصلاحها. يمكن بعد ذلك للموجه إعادة تحميل الإعدادات المخصصة، وستتمكن الأجهزة الأخرى (كالمودم) من إعادة اكتشاف الموجه والاتصال به. وتسمى هذه العملية إعادة التشغيل.

لإعادة تشغيل الموجه باستخدام سلك التيار، قم بما يلي:

1. افصل سلك التيار من الموجه ومن المودم.
2. انتظر 10 ثوان، ثم أعد توصيل سلك التيار بالمودم. تأكد من وجود تيار به.
3. انتظر حتى يتوقف مؤشر اتصال المودم بالإنترنت عن الوميض (لمدة دقيقتين تقريباً). أعد توصيل سلك التيار بالموجه.
4. انتظر حتى تشغيل شعار Linksyst المضيء. انتظر لدقيقتين قبل محاولة الاتصال بالإنترنت من جهاز كمبيوتر.

لإعادة تشغيل الموجه باستخدام Linksyst Smart Wi-Fi، قم بما يلي:

1. سجّل الدخول إلى Linksyst Smart Wi-Fi: (راجع "كيفية الاتصال بـ Linksyst Smart Wi-Fi" في الصفحة 10).
2. تحت Router Settings (إعدادات الموجه)، انقر فوق Troubleshooting (استكشاف المشكلات وإصلاحها).

3. انقر فوق علامة التبويب *Diagnostics* (التشخيصات).

4. تحت *Reboot* (إعادة التشغيل)، انقر فوق *Reboot* (إعادة تمهيد).



5. انقر فوق *Yes* (نعم). ستتم إعادة تشغيل الموجه. أثناء إعادة تشغيل الموجه، ستفقد جميع الأجهزة اتصالها بالإنترنت، وستُعيد الاتصال تلقائيًا عندما يصبح الموجه جاهزًا للاتصال مرة أخرى.

### Linksys Smart Wi-Fi لا يفتح في مستعرض الويب

تعمل أحدث إصدارات Google Chrome™ و Firefox® و Safari® (لأجهزة Mac® و iPad®) و Microsoft Edge و Internet Explorer® الإصدار 8 والإصدارات الأحدث مع Linksys Smart Wi-Fi.

## Linksys EA8300

اسم الطراز	موجه Max-Stream AC2200 MU-MIMO ثلاثي النطاق
رقم الطراز	EA8300
سرعة منفذ المحول	1000/100/10 ميغابت/ث (Gigabit Ethernet)
تردد الإشارات اللاسلكية	2.4 غيغاهرتز و 5 غيغاهرتز (x2)
عدد أجهزة الهوائي	4 هوائيات خارجية قابلة للضبط (غير قابلة للفك)
المنافذ	منفذ USB 3.0، منفذ Ethernet (4-1)، منفذ الإنترنت، منفذ الطاقة
الأزرار	Wi-Fi Protected Setup، الطاقة، إعادة الضبط
اللمبات	اللوحة العلوية: شعار Linksys المضيء، Wi-Fi Protected Setup، اتصال إنترنت، اتصال كبل الشبكة بمنفذ الإنترنت اللوحة الخلفية: منفذ USB، منفذ Ethernet (4-1)، منفذ الإنترنت
UPnP	معتمد
مميزات الأمان	WEP, WPA2, RADIUS
مفتاح الأمان	تشفير يصل لغاية 128 بت
دعم نظام ملفات التخزين	FAT و NTFS و HFS+
دعم المستعرض	أحدث إصدارات من Safari® و Firefox® و Google Chrome™ و Internet Explorer® و Microsoft Edge و (Mac® و iPad®) الإصدار رقم 8 والإصدارات الأحدث

## المعطيات البيئية

الأبعاد	213.7 مم × 161.8 مم × 54.8 مم (بدون أجهزة الهوائي)
وزن الوحدة	g 608
وحدة التزويد بالطاقة	V 2A12
الشهادات	(FCC, IC, CE, Wi-Fi (a/b/g/n/ac)
درجة حرارة التشغيل	32 إلى 104 درجات فهرنهايت (0 إلى 40 درجة مئوية)
درجة حرارة التخزين	-4 إلى 140 درجة فهرنهايت (-20 إلى 60 درجة مئوية)
الرطوبة	10% إلى 80% رطوبة نسبية، بدون تكثف
رطوبة التخزين	10 إلى 90% دون تكاثف

يمكن أن تخضع المواصفات للتغيير دون إشعار.

ملاحظات:

للحصول على معلومات تنظيمية ومتعلقة بالضمان والسلامة، راجع القرص المضغوط المرفق بالموجّه أو انتقل إلى [Linksys.com/support/EA8300](http://Linksys.com/support/EA8300).

درجة أداء قصوى متأتية من مواصفات معايير IEEE 802.11. يختلف الأداء الفعلي بما في ذلك قدرة الشبكة اللاسلكية المتدنية، وسرعة أداء البيانات، والنطاق، والتغطية. يعتمد الأداء على عوامل، وشروط، ومتغيرات تشمل المسافة من نقطة الوصول، وحجم حركة بيانات الشبكة، ومواد الإنشاء والتركييب ونظام التشغيل المُستخدَم، بالإضافة إلى التداخل وظروف معاكسة أخرى.

BELKIN, LINKSYS والعديد من أسماء المنتجات وشعاراتها هي علامات تجارية لمجموعة شركات Belkin. وتكون العلامات التجارية المذكورة الخاصة بالأطراف الثالثة ملكًا لأصحابها المعيّنين. التراخيص والإشعارات الخاصة ببرامج الأطراف الثالثة المستخدمة في هذا المنتج قد تعرض هنا: <http://support.linksys.com/en-us/license>. يرجى الاتصال بـ <http://support.linksys.com/en-us/gplcodecenter> لأي استفسارات أو طلبات التعليمات البرمجية المصدر طبقًا لرخصة جنو العمومية (GPL).

حقوق النشر © لعام 2017 محفوظة لشركة Belkin International, Inc. و/أو الشركات التابعة لها. جميع الحقوق محفوظة.

**LINKSYS®**

Ръководство за потребителя

**MAX-STREAM™**  
**AC2200 MU-MIMO**  
**ТРИЛЕНТОВ РУТЕР**

Модел EA8300

# Съдържание

<b>Общ преглед на продукта.....</b>	<b>3</b>
Изглед отгоре .....	3
Индикатор за състоянието на системата .....	4
Изглед отзад .....	5
Изглед отстрани.....	6
<b>Настройване: Основни положения .....</b>	<b>7</b>
Къде да намерите още помощ.....	7
Как да инсталирате рутера .....	8
<b>Как да използвате Linksys Smart Wi-Fi.....</b>	<b>11</b>
Как да се свържете към Linksys Smart Wi-Fi.....	11
Мрежова карта.....	12
Достъп за гости.....	12
Родителски контрол .....	13
Приоритизиране на медии.....	13
Тест на скоростта .....	14
Външно съхранение.....	14
Свързаност .....	15
Отстраняване на неизправности .....	15
Безжична мрежа .....	16
Защита.....	16
<b>Отстраняване на неизправности.....</b>	<b>17</b>
Вашият рутер не е настроен успешно.....	17
Съобщение Your Internet cable is not plugged in (Вашият интернет кабел не е включен) .....	18
Съобщение Cannot access your router (Не е възможно да се осъществи достъп до Вашия рутер).....	19
След настройката.....	21
Изглежда няма интернет .....	21
Linksys Smart Wi-Fi не се отваря в уеб браузъра .....	22
<b>Спецификации .....</b>	<b>23</b>
Linksys EA8300 .....	23
Данни за околната среда .....	23



# Общ преглед на продукта

## Изглед отгоре

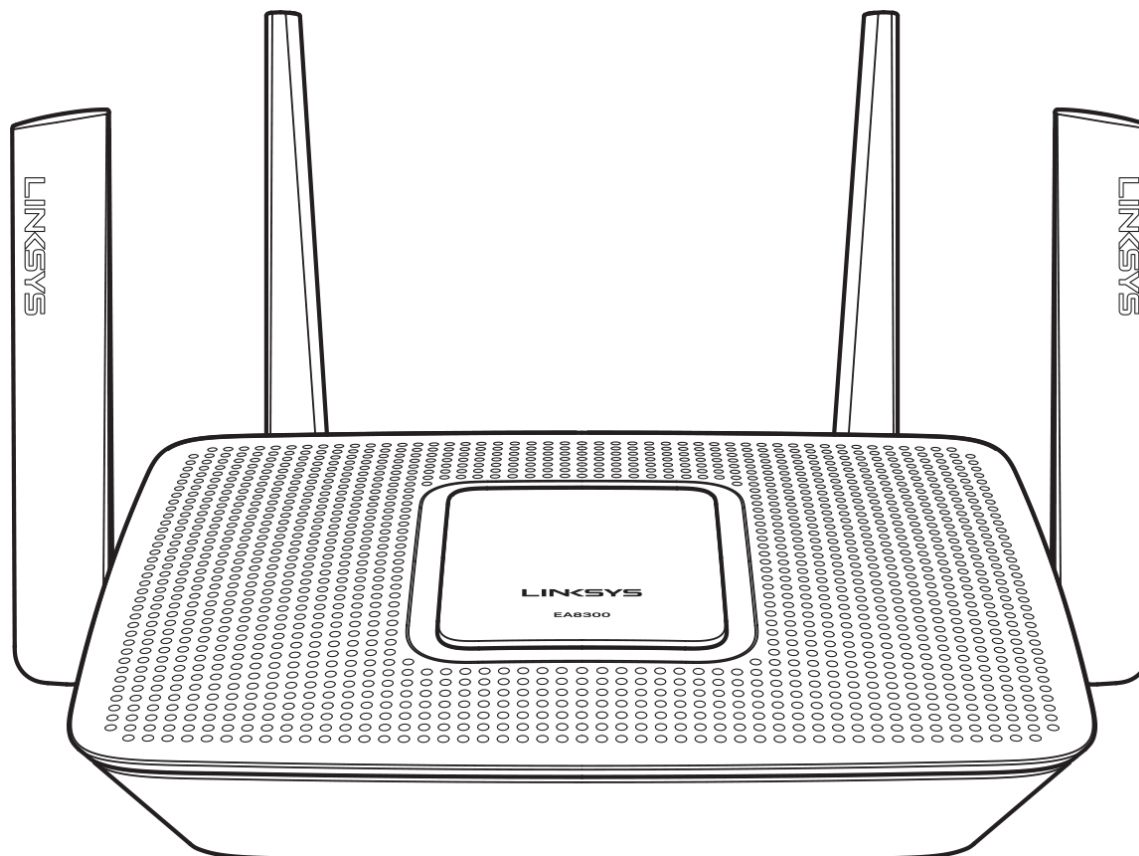

## Индикатор за състоянието на системата

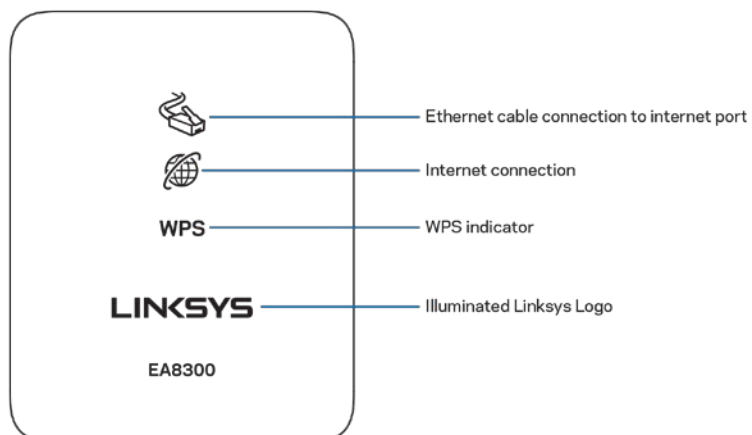

**Свързване с Ethernet кабел към Интернет порт (1)**– когато свети (в оранжево), показва наличие на проблем с мрежовия кабел, свързан към Интернет (WAN) порта.

**Интернет връзка**– когато свети (в оранжево), показва, че рутерът не може да получи достъп до Интернет.

**WPS (Wi-Fi Protected Setup™) indicator**– светоиндикаторът WPS има четири състояния:

<b>Изкл.</b>	Няма активност на Wi-Fi Protected Setup
<b>Примигващо бяло</b>	Wi-Fi Protected Setup е в ход
<b>Постоянно бяло</b>	Wi-Fi Protected Setup приключи успешно; остава да свети в продължение на пет секунди
<b>Примигващо оранжево</b>	Грешка при Wi-Fi Protected Setup; мига в продължение на една минута, след това изгасва

**Светещо лого на Linksys**– Логото мига, докато рутерът се стартира. Когато логото свети с постоянна бяла светлина, рутерът получава захранване и работи правилно.

## Изглед отзад

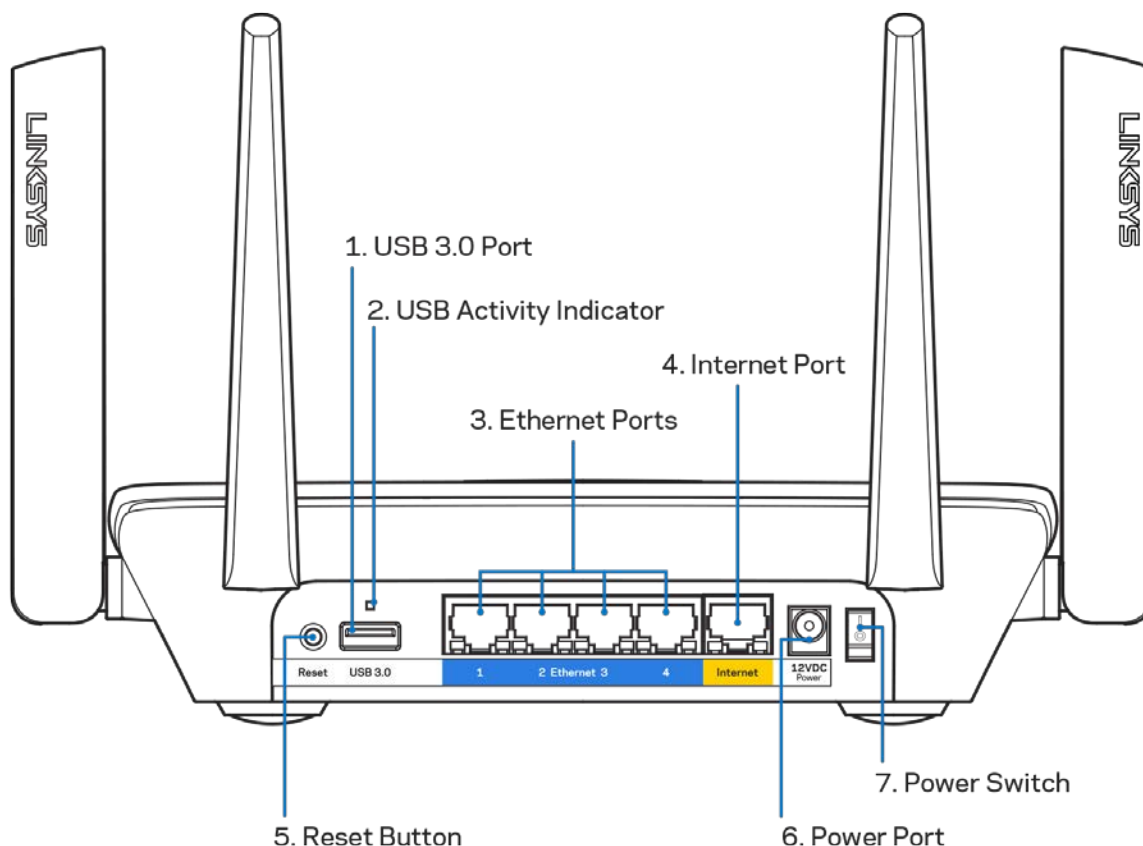

**Порт USB 3.0 (1)** — Свържете и споделете USB устройства в мрежата си или по Интернет.

**Светоиндикатор за USB активност (2)** – Свети, когато се извършва прехвърляне на данни към/от външни устройства.

**Ethernet портове (3)** — Свържете Ethernet кабели към тези сини гигабитови (10/100/1000) портове и към кабелните устройства в мрежата.

*Забележка - За да си осигурите възможно най-добри характеристики, използвайте кабели CAT5e или по-висок клас за Ethernet портовете.*

**Интернет порт (4)** — Свържете Ethernet кабел към този жълт гигабитов (10/100/1000) порт и към кабел за широколентов Интернет/DSL или оптичен модем.

*Забележка - За да си осигурите възможно най-добри характеристики, използвайте кабел CAT5e или по-висок клас за Интернет порта.*

**Бутон Reset (Нулиране) (5)** — Натиснете и задръжте, докато светещото лого на Linksys започне да мига, за да нулирате рутера до фабричните му настройки. Можете да възстановите фабричните настройки и чрез Linksys Smart Wi-Fi по интернет или през мобилно приложение.

**Захранващ порт (6)** — Свържете включения в комплекта променливотоков захранващ адаптер.

**Превключвател на захранването (7)** — Натиснете | (вкл.), за да включите рутера.

## Изглед от страни

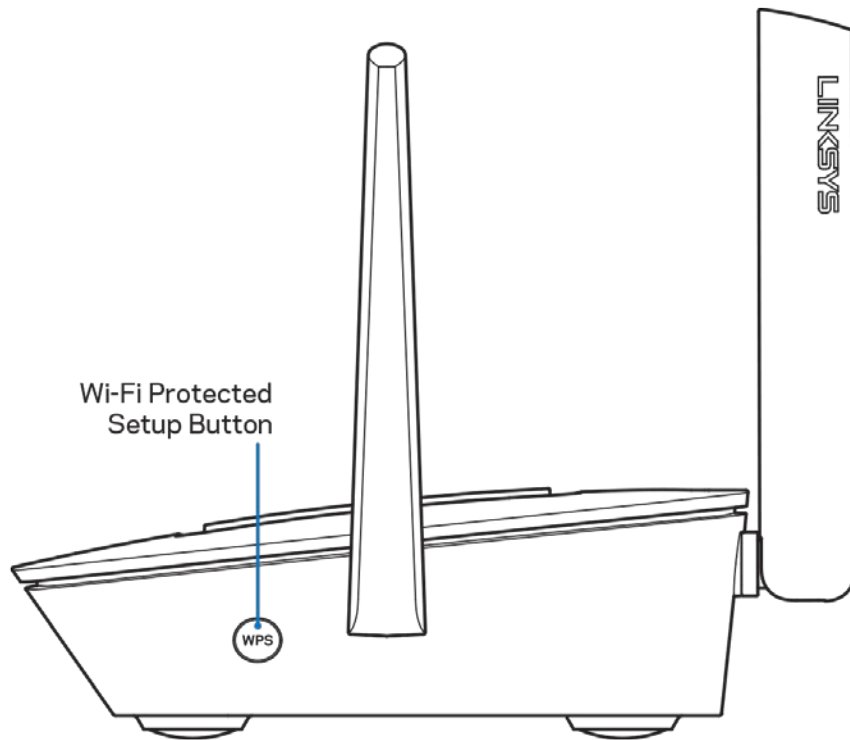

**Бутон Wi-Fi Protected Setup™** - Натиснете, за да свържете към мрежови устройства с активиран WPS.

# Настройване: Основни положения

## Къде да намерите още помощ

Освен в това ръководство за потребителя можете да получите помощ на следните места:

- [Linksys.com/support/EA8300](http://Linksys.com/support/EA8300) (документация, материали за изтегляне, ЧЗВ, техническа поддръжка, чат в реално време, форуми)
- Помощ за Linksys Smart Wi-Fi (свържете се с Linksys Smart Wi-Fi, след което кликнете върху Help (Помощ) в горната част на екрана)

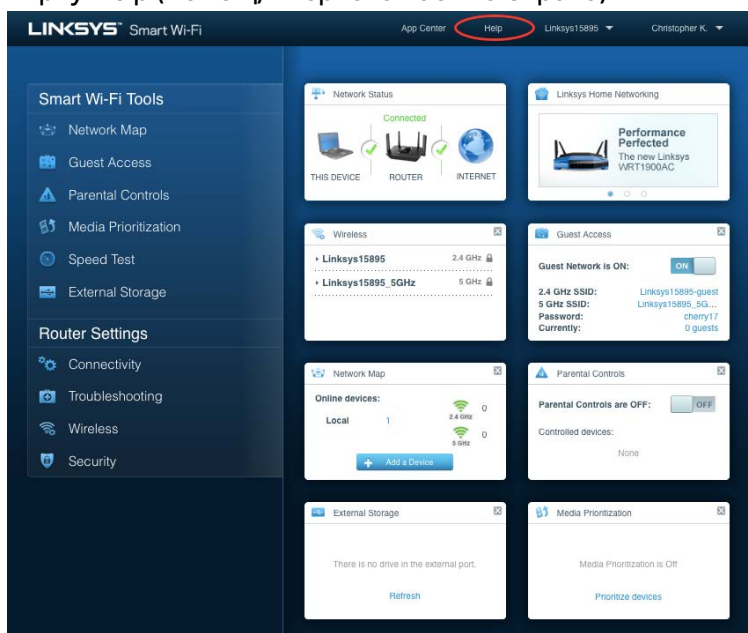

The screenshot shows the Linksys Smart Wi-Fi web interface. The top navigation bar includes 'App Center', 'Help' (highlighted with a red circle), 'Linksys15895', and 'Christopher K.'. The main content area is divided into several sections: 'Smart Wi-Fi Tools' (Network Map, Guest Access, Parental Controls, Media Prioritization, Speed Test, External Storage), 'Router Settings' (Connectivity, Troubleshooting, Wireless, Security), and various status widgets (Network Status, Linksys Home Networking, Wireless, Guest Access, Network Map, Parental Controls, External Storage, Media Prioritization).

### Help

#### Using Linksys Smart Wi-Fi

Linksys Smart Wi-Fi allows you to access all of your router's features and settings. Simply click on a feature or widget you want to open.

You can use Linksys Smart Wi-Fi to:

- See what's currently connected to your network, and connect more computers and devices.
- Create a Linksys Smart Wi-Fi account to access router settings from anywhere using any browser, even when you're away from home. You can personalize your router and change settings for wireless access, Internet, gaming, local network, and more. You can even access router settings for multiple routers, which is helpful if you set up and manage more than one router. (The account is available only on EA-Series routers.)
- Allow guests in your home to use the Internet without giving them access to your network. While on the guest network, users can surf the net, but won't be able to access your printers, other computers, or devices on your network.

#### Help Categories

- Linksys Smart Wi-Fi
- Device List
- Guest Access
- Parental Controls
- Media Prioritization
- Speed Test
- External Storage
- Connectivity

Ok

**Забележка** — Лицензите и бележките относно софтуера от трети страни, използван с този продукт, можете да видите на адрес <http://support.linksys.com/en-us/license>. За въпроси или за искания за GPL отворен код, моля, свържете се с <http://support.linksys.com/en-us/gplcodecenter>.

## Как да инсталирате рутера

1. За да завършите настройката, ще е необходимо да посетите <http://LinksysSmartWiFi.com> през уеб браузър на компютър.
2. Идентифицирайте оборудването си.



3. Поставете антените изправени и включете рутера към захранващ източник. Уверете се, че превключвателят за захранването е в положение | (вкл.).
4. Свържете рутера към модема или модем-рутера. Включете единия край на доставения в комплекта интернет кабел към жълтия интернет порт на новия рутер. Ако имате модем, включете другия край в Ethernet (LAN) порта на модема. Ако имате модем-рутер, включете го в някой от наличните портове.
5. Изчакайте, докато светещият светоиндикатор на Linksys върху рутера спре да мига и започне да свети постоянно в бяло.
6. Свържете към името на Wi-Fi, посочено в Ръководството за бързо стартиране, което сте получили заедно с рутера. (По-късно можете да смените тези данни.) Ако се нуждаете от помощ при свързването към мрежата, направете справка в документацията на устройството на адрес [linksys.com/support/ea8300](http://linksys.com/support/ea8300).

**Забележка** — Няма да имате достъп до интернет, докато не завърши настройката на рутера.

7. Въведете <http://LinksysSmartWiFi.com> в уеб браузър. Следвайте инструкциите на екрана, за да завършите настройката на рутера. Можете също така да въведете 192.168.1.1 в браузъра, за да започнете първоначалната настройка.

В края на настройката следвайте указанията на екрана, за да настроите профила си за Linksys Smart Wi-Fi. Използвайте Linksys Smart Wi-Fi, за да конфигурирате рутера от който и да е компютър с интернет връзка.

Управление на настройките на рутера:

- Смяна на името и паролата на рутера
- Създаване на достъп за гости;
- Конфигуриране на родителски контрол;
- Свързване на устройства към Wi-Fi
- Тестване на скоростта на интернет връзката

**Забележка** - Като част от настройването на профил за Linksys Smart Wi-Fi ще Ви бъде изпратен имейл за потвърждение. От домашната си мрежа кликнете върху връзката в имейла, за да асоциирате рутера с профила за Linksys Smart Wi-Fi.

**Съвет** — Отпечатайте следващата страница и след това запишете настройките на рутера и профила си в таблицата по-долу, за да ги използвате за справка. Запазете бележките си на сигурно място.

Име на 2,4 GHz Wi-Fi	
Парола за Wi-Fi	
Име на 5 GHz <sub>1</sub> Wi-Fi	
Парола за Wi-Fi	
Име на 5 GHz <sub>2</sub> Wi-Fi	
Парола за Wi-Fi	
Парола за рутера	
Име на Wi-Fi мрежата за гости на 2,4 GHz	
Име на Wi-Fi мрежата за гости на 5GHz	
Парола на Wi-Fi мрежата за гости (Двете използват една и съща парола.)	
Потребителско име за Linksys Smart Wi-Fi	
Парола за Linksys Smart Wi-Fi	



# Как да използвате Linksys Smart Wi-Fi

Можете да управлявате рутера от всяка точка на света, като използвате Linksys Smart Wi-Fi, но можете да направите това и директно от домашната си мрежа. Linksys Smart Wi-Fi може да се използва и от мобилното ви устройство. За повече информация вижте в магазина за приложения на устройството.

## Как да се свържете към Linksys Smart Wi-Fi

За да се свържете към Linksys Smart Wi-Fi:

1. Отворете уеб браузър на компютъра.
2. Отидете на <http://LinksysSmartWiFi.com> и влезте в профила си.

Ако не можете да си спомните паролата, кликнете върху *Forgot your password (Забравена парола)?* и следвайте инструкциите на екрана, за да я възстановите.

## Мрежова карта

Дава ви възможност да видите и управлявате всички мрежови устройства, свързани към рутера ви. Можете да видите устройствата в главната си мрежа или в тази за гости, или да видите информация за всяко от устройствата.



## Достъп за гости

Дава ви възможност да настроите и да наблюдавате мрежа за гости, която да дава възможност за достъп до Wi-Fi без експозиция на личните ви данни.

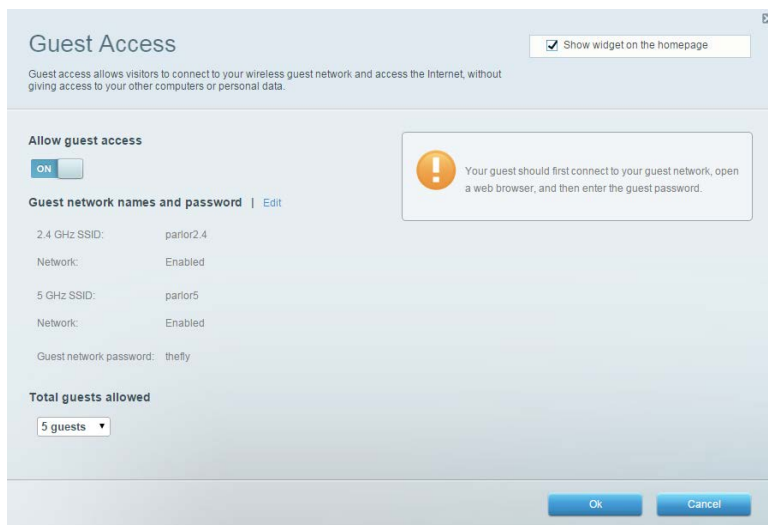

## Родителски контрол

Дава ви възможност да блокирате достъпа до веб сайтове и да задавате часове за достъп до интернет.

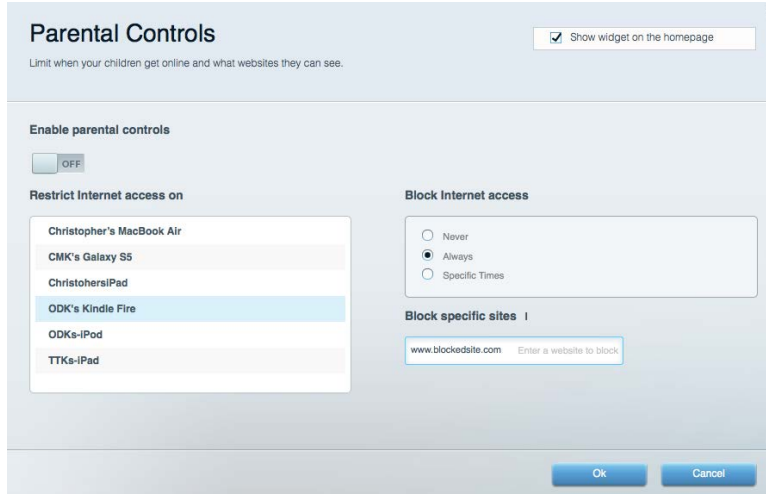

## Приоритизиране на медии

Дава ви възможност да зададете устройства и приложения с най-висок приоритет в мрежовия трафик.

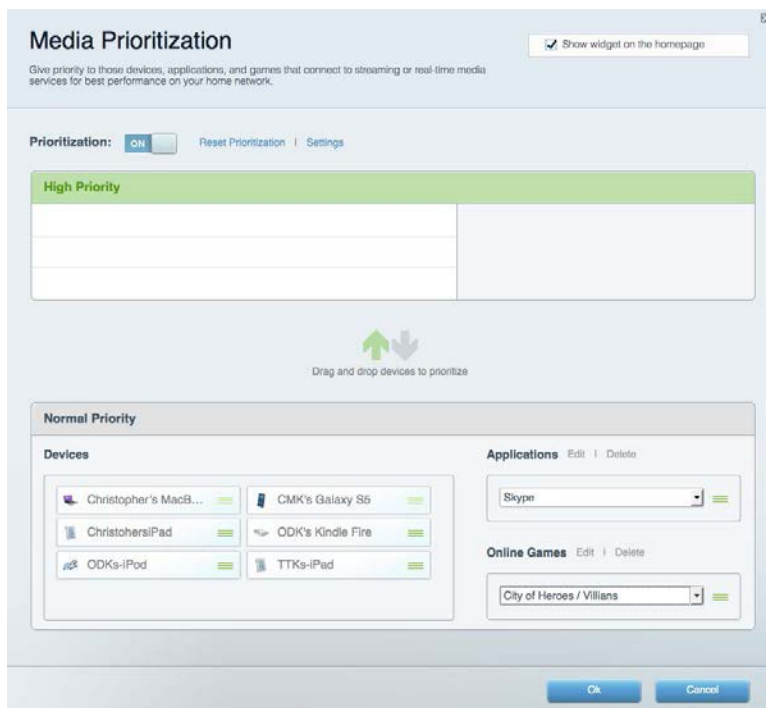

## Тест на скоростта

Дава ви възможност да тествате скоростта на интернет връзката на мрежата.



## Външно съхранение

Дава ви възможност да получите достъп до свързано USB устройство (не е включено в комплекта) и да настроите споделянето на файлове, мултимедиен сървър и FTP достъп.

The image shows an 'External Storage' configuration window with the following details:

- External Storage Drive:**
  - Volume name: ROUND DRIVE
  - Space used: 886 MB used of 960 MB total.
  - Buttons: 'Safely remove drive' and 'Refresh'
- Folder Access:**
  - Status:  Show widget on the homepage
  - Secure Folder Access is OFF: Any user can access content via shared folders.
  - Access paths: PC access (File explorer): \\192.168.1.1; Mac access (Finder): smb://192.168.1.1
- FTP Server:**
  - FTP Server is OFF: Content is not accessible to any user via FTP.
  - FTP server: Disabled
- Media Server (DLNA):**
  - Media Server (DLNA) is ON: Media content is accessible to DLNA clients.
  - DLNA server: EA6050
- Footer:** 'Ok' button

## Свързаност

Дава ви възможност да прегледате и промените основните и разширените мрежови настройки.

The screenshot shows the 'Connectivity' settings page. It has a title bar with a close button and a subtitle 'View and change router settings'. Below the title bar are tabs for 'Basic', 'Internet Settings', 'Local Network', 'Advanced Routing', 'VLAN', and 'Administration'. The 'Basic' tab is selected. The page is divided into several sections: 'Network Name and Password' with fields for 2.4 GHz and 5 GHz network names and passwords; 'Router Password' with a masked password field; 'Router Firmware Update' with a checked 'Automatic' checkbox and a 'Check for Updates' button; 'Time Zone' with a dropdown menu set to '(GMT-05:00) Eastern Time (USA & Canada)' and a checked 'Automatically adjust for Daylight Savings Time' checkbox; and 'Activity Lights' with an 'ON' toggle and a text box explaining the power light behavior. At the bottom are 'Ok', 'Cancel', and 'Apply' buttons.

## Отстраняване на неизправности

Дава ви възможност да правите диагностика на проблеми с рутера и да проверявате състоянието на мрежата.

The screenshot shows the 'Troubleshooting' page. It has a title bar with a close button and a subtitle 'Troubleshoot router settings'. Below the title bar are tabs for 'Status', 'Diagnostics', and 'Logs'. The 'Diagnostics' tab is selected. The page is divided into several sections: 'Ping IPv4' with input fields for IP or host name and number to ping, and a 'Start to Ping' button; 'Trace route' with an input field for IP or host name and a 'Start to Traceroute' button; 'Reboot' with a 'Reboot the router' link; 'Router configuration' with 'Backup' and 'Restore' buttons; 'Router Firmware' with a 'Restore previous firmware' button; 'Internet Address' showing IPv4 (10.0.0.253) and IPv6 (2601:0540::000:0019:0000:0000:0000:314e) addresses with 'Release and Renew' links; and 'Factory reset' with a 'Reset to factory default settings' link. At the bottom is an 'Ok' button.

## Безжична мрежа

Дава ви възможност да прегледате и промените безжичната мрежа на рутера. Можете да смените имената на мрежите, режима на защита, паролата, филтрирането по MAC адрес, както и да свързвате устройства с помощта на Wi-Fi Protected Setup.

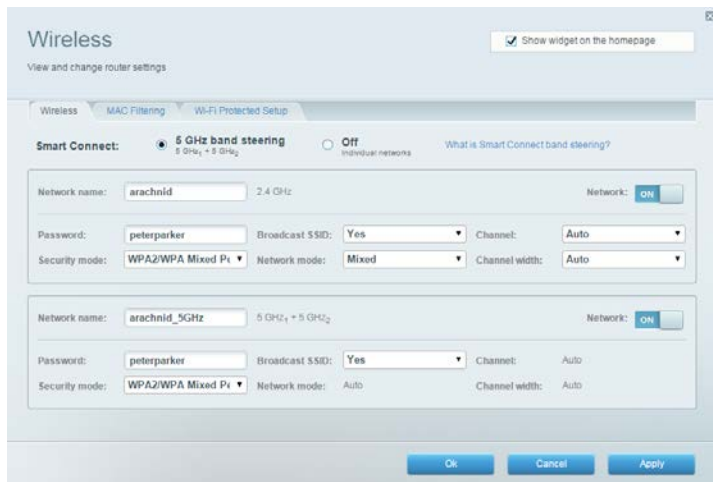

## Защита

Дава ви възможност да прегледате и промените настройките за защита на безжичната мрежа. Можете да настроите защитната стена, настройките за VPN, както и да направите персонализирани настройки за приложения и игри.

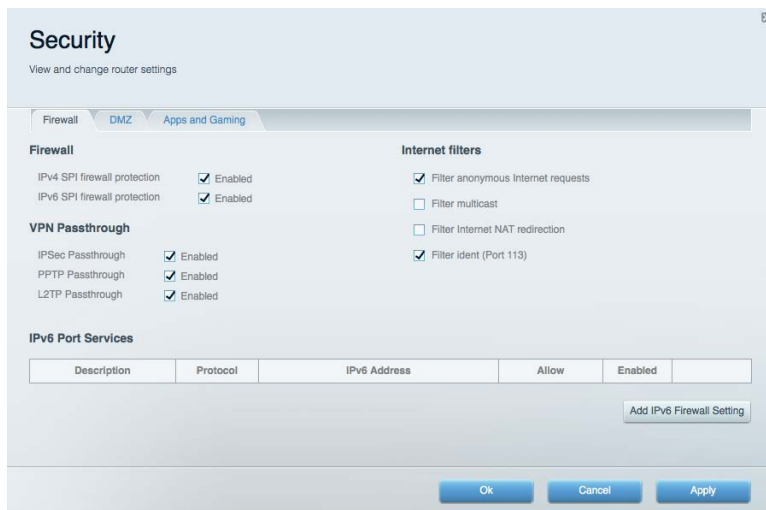

# Отстраняване на неизправности

Още помощ можете да намерите от нашия отличаван с награди отдел за обслужване на клиенти на адрес [linksys.com/support/EA8300](https://linksys.com/support/EA8300).

## Вашият рутер не е настроен успешно

Ако Linksys Smart Wi-Fi не завърши настройката, можете да опитате следното:

- Натиснете и задръжте натиснат бутона Reset (Нулиране) на рутера с кламер или карфица, докато светещото лого на Linksys угасне и сините индикатори на MU-MIMO започнат да мигат (около 10 секунди). Инсталирайте рутера отново.

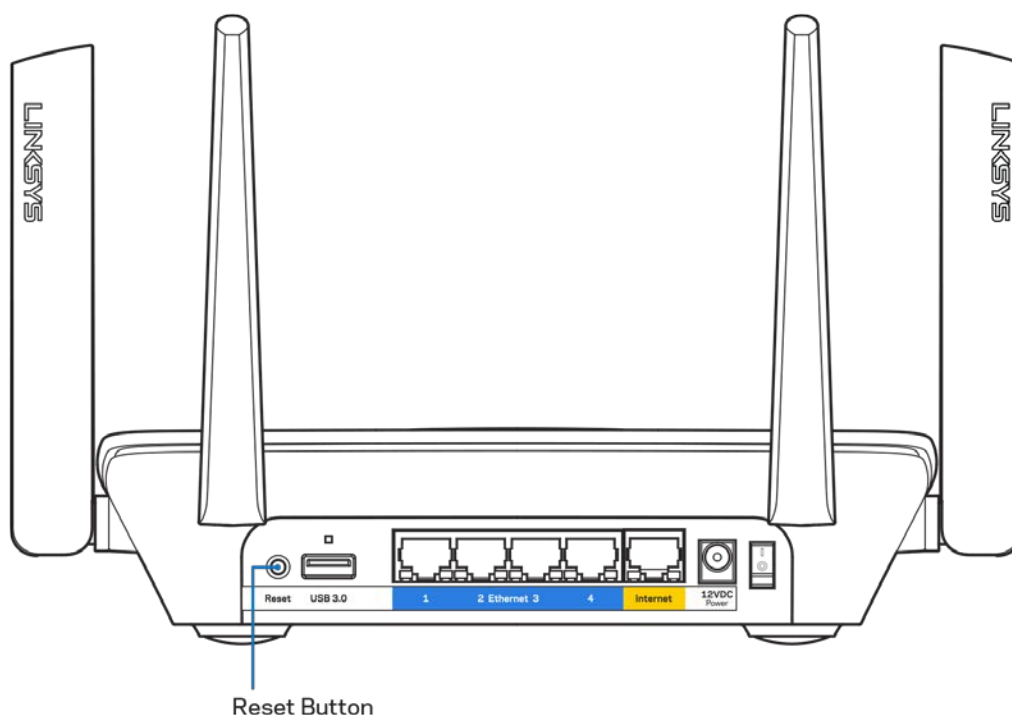

- Временно изключете защитната стена на компютъра си (за помощ вижте инструкциите на софтуера). Инсталирайте рутера отново.
- Ако имате друг компютър, използвайте го, за да инсталирате отново рутера.

## Съобщение *Your Internet cable is not plugged in (Вашият интернет кабел не е включен)*

Ако получите съобщение Your Internet cable is not plugged in (Вашият интернет кабел не е включен), докато се опитвате да настроите рутера, изпълнете следните стъпки за отстраняване на неизправността.

- Уверете се, че ethernet кабелът или кабелът за интернет (или кабел, подобен на предоставения заедно с рутера) е свързан стабилно към жълтия интернет порт от задната страна на рутера и към съответния порт на модема. Този порт за модем е обикновено с обозначение Ethernet.

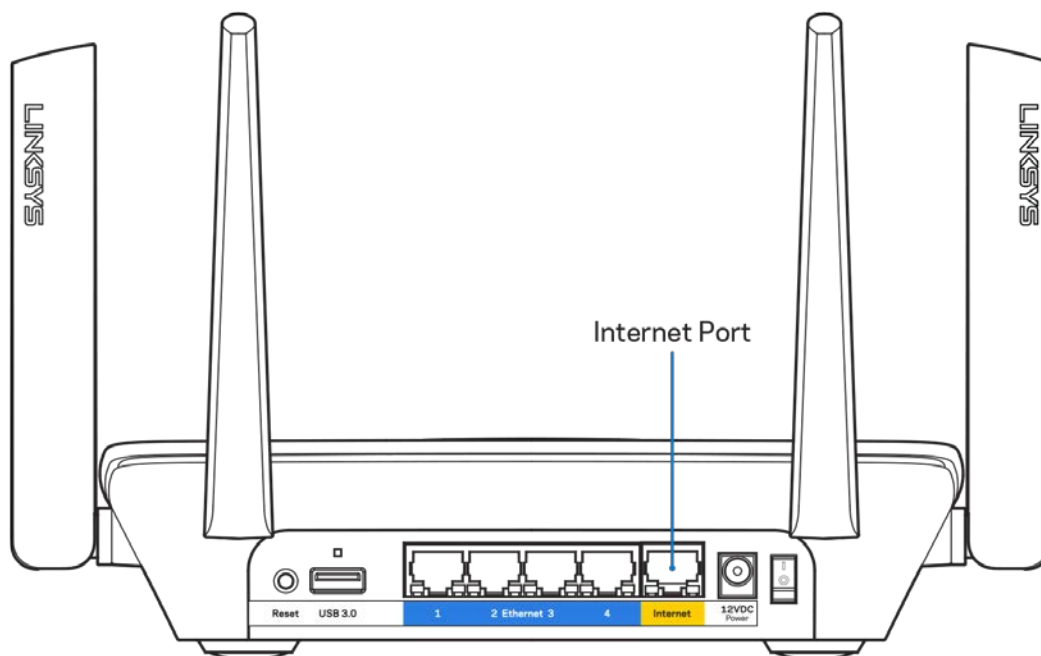

- Уверете се, че модемът ви е свързан към захранване и включен. Ако има ключ за захранването, уверете се, че е в положение ON (Вкл.) или I (обратното на O).

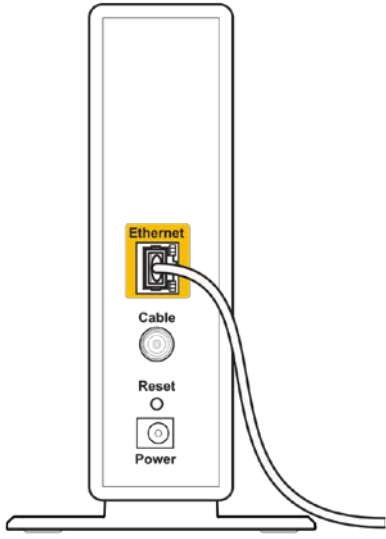
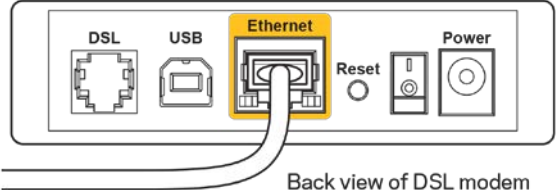

 <p>Back view of cable modem</p>	 <p>Back view of DSL modem</p>
<p>Ако използвате кабелен интернет, проверете дали CABLE портът на кабелния модем е свързан към коаксиалния кабел, предоставен от доставчика на интернет.</p>	<p>Ако използвате интернет услуга чрез DSL, уверете се, че DSL телефонната линия е свързана към DSL порта на модема.</p>

- Ако компютърът ви преди е бил свързан към модем с USB кабел, откачете USB кабела.
- Инсталирайте рутера отново.

## Съобщение *Cannot access your router (Не е възможно да се осъществи достъп до Вашия рутер)*

За да имате достъп до рутера, трябва да бъдете свързани към собствената си мрежа. Ако в момента имате безжичен достъп до Интернет, проблемът може би е, че случайно сте се свързали с друга безжична мрежа.

За да решите проблема при компютри под Windows, направете следното:

1. Кликнете върху иконата за безжична връзка в системната област. Ще се покаже списък с наличните безжични мрежи.

2. Кликнете върху името на вашата мрежа. Кликнете върху Connect (Свързване). В дадения по-долу пример компютърът е свързан с друга безжична мрежа с името wraith\_5GHz. Името на безжичната мрежа на рутера Linksys EA8300, в този пример Damaged\_Beez2.4, е показано като избрано.



3. Ако бъдете помолени да въведете мрежов ключ, въведете паролата си (ключ за сигурност) в полето за ключа за мрежова сигурност. Кликнете върху **OK**.
4. Компютърът се свързва с мрежата и вече трябва да имате достъп до рутера.

*\*В зависимост от версията на Windows може да има различия в текста или в иконите, посочени в тези стъпки.*

За да решите проблема при компютри Mac, направете следното:

1. Кликнете върху иконата Wi-Fi в лентата с менюто в горната част на екрана. Ще се покаже списък с безжични мрежи.
2. В дадения по-долу пример компютърът е свързан с друга безжична мрежа с името wraith\_5GHz. Името на безжичната мрежа на рутера Linksys EA8300, в този пример Damaged\_Beez2.4, е показано като избрано.



3. Кликнете върху името на безжичната мрежа на рутера Linksys EA8300 (Damaged\_Beez2.4 в примера).
4. Въведете паролата за безжичната мрежа (Защитен ключ) в полето *Password (Парола)*. Кликнете върху **ОК**.

## След настройката

### Изглежда няма интернет

Ако има трудности при комуникацията на интернет с рутера, проблемът може да се покаже като съобщение „Cannot find [Internet address]“ (Не може да бъде намерен [Интернет адрес]) в уеб браузъра. Ако знаете, че интернет адресът е правилен и ако сте пробвали да се свържете с няколко валидни интернет адреса със същия резултат, съобщението може да означава, че има проблем с доставчика на интернет или с модема, който комуникира с рутера. Опитайте следното:

- Уверете се, че мрежовите и захранващите кабели са добре свързани.
- Уверете се, че електрическият контакт, към който е свързан рутерът, осигурява захранване.
- Рестартирайте рутера.
- Свържете се с доставчика на Интернет и попитайте дали няма проблеми във вашата зона.

Най-често използваният метод за отстраняване на неизправностите на рутера е да го изключите и да го включите отново. Тогава рутерът може да презареди персонализираните си настройки, а другите устройства (например модемът) ще могат да открият отново рутера и да комуникират с него. Този процес се нарича рестартиране.

За да рестартирате рутера от захранващия кабел, направете следното:

1. Изключете захранващия кабел от рутера и от модема.
2. Изчакайте 10 секунди и свържете отново захранващия кабел към модема. Уверете се, че по него тече ток.
3. Изчакайте индикаторът за онлайн дейност на модема да спре да мига (около две минути). Свържете отново захранващия кабел към рутера.

4. Изчакайте, докато логото на Linksys светне. Изчакайте две минути, преди да се опитате да се свържете към интернет от някой компютър.

За да рестартирате рутера посредством Linksys Smart Wi-Fi, направете следното:

1. Влезте в Linksys Smart Wi-Fi. (Вижте „Как да се свържете към Linksys Smart Wi-Fi“ на стр. [11](#).)
2. В *Router Settings (Настройки на рутера)* кликнете върху *Troubleshooting (Отстраняване на неизправности)*.
3. Кликнете върху раздела *Diagnostics (Диагностика)*.
4. В *Reboot (Рестартиране)* кликнете върху *Reboot (Рестартиране)*.



5. Кликнете върху **Yes (Да)**. Рутерът ще се рестартира. Докато рутерът се рестартира, всички свързани устройства ще загубят интернет връзката си и ще се свържат отново автоматично, когато той е готов.

## Linksys Smart Wi-Fi не се отваря в уеб браузъра

Най-новите версии на Google Chrome™, Firefox®, Safari® (за Mac® и iPad®), Microsoft Edge и Internet Explorer® версия 8 и по-нови работят с Linksys Smart Wi-Fi.

# Спецификации

## Linksys EA8300

Име на модела	Трилентов рутер Max-Stream AC2200 MU-MIMO
Номер на модела	EA8300
Скорост на порта на превключвателя	10/100/1000 Mbps (гигабитов Ethernet)
Радиочестота	2,4 GHz и 5 GHz (x2)
Брой антени	4 външни регулируеми антени (неразглобяеми)
Портове	USB 3.0, Ethernet (1-4), Интернет, захранващ
Бутони	Wi-Fi, Wi-Fi Protected Setup, захранване, нулиране
Светлинни индикатори	<b>Горен панел:</b> Светещо лого на Linksys, Wi-Fi Protected Setup, връзка с Интернет, свързване с мрежов кабел към Интернет порта <b>Заден панел:</b> USB 3.0, Ethernet (1-4), Интернет
UPnP	Поддържа се
Защитни функции	WEP, WPA2, RADIUS
Битове на ключа за защита	До 128-битово шифроване
Поддръжка на файловата система за съхранение	FAT, NTFS и HFS+
Поддръжка на браузъри	Най-новите версии на Google Chrome™, Firefox®, Safari® (за Mac® и iPad®), Microsoft Edge, Internet Explorer® версия 8 и по-нови

## Данни за околната среда

Размери	213,7mm x 161,8mm x 54,8mm (без антени)
Тегло на устройството	608 g
Захранване	12 V, 2A
Сертификати	FCC, IC, CE, Wi-Fi (a/b/g/n/ac)
Работна температура	от 32 до 104 °F (от 0 до 40°C)
Температура на съхранение	от -4 до 140 °F (от -20 до 60°C)
Работна влажност	10 % до 80 % относителна влажност, без кондензация
Влажност за съхранение	5 % до 90 % без кондензация

Спецификациите подлежат на промяна без предизвестие.

**Забележки:**

За информация относно нормативната уредба, гаранцията и безопасността, вижте компактдиска, доставен с вашия рутер, или отидете на адрес [Linksys.com/support/EA8300](http://Linksys.com/support/EA8300).

\* Максималните работни показатели са извлечени от спецификациите на Стандарт 802.11 на IEEE. Действителните работни показатели може да са различни, включително по-нисък капацитет за работа в безжична мрежа, пропускателна способност за данни, диапазон и покритие. Ефективността зависи от много фактори, условия и променливи, включително разстоянието от точката на достъп, обема на мрежовия трафик, строителните материали и конструкцията, използваната операционна система, използвания комплект продукти за безжичен достъп, смущенията и други неблагоприятни условия.

BELKIN, LINKSYS и много имена на продукти и логотипи са търговски марки на групата дружества Belkin. Упоменатите търговски марки на трети страни са собственост на съответните им притежатели. Лицензите и бележките относно софтуера от трети страни, използван с този продукт, можете да видите тук: <http://support.linksys.com/en-us/license>. Моля, свържете се с <http://support.linksys.com/en-us/gplcodecenter> за въпроси или за заявки за GPL отворен код.

© 2017 Belkin Systems, Inc. и/или нейните филиали. Всички права запазени

**LINKSYS®**

Uživatelská příručka

**MAX-STREAM™  
AC2200 MU-MIMO  
TŘÍPÁSMOVÝ ROUTER**

Model EA8300

# Obsah

Přehled produktu.....	3
Horní pohled.....	3
Indikátor stavu baterie .....	4
Zadní pohled.....	5
Boční pohled.....	6
Instalace: Základy .....	7
Kde získáte další pomoc.....	7
Postup instalace routeru.....	8
Jak používat Linksys Smart Wi-Fi .....	11
Připojení k Linksys Smart Wi-Fi .....	11
Mapa sítě .....	12
Přístup s právy hosta .....	12
Rodičovská kontrola.....	13
Priorita médií.....	13
Test rychlosti .....	14
Externí úložiště .....	14
Připojení .....	15
Odstraňování problémů.....	15
Bezdrátové připojení .....	16
Zabezpečení.....	16
Odstraňování problémů .....	17
Váš router nebyl úspěšně nainstalován.....	17
Zpráva „Your Internet cable is not plugged“ (Internetový kabel není připojen).....	18
Zpráva „Cannot access your router“ (Nelze přistupovat k routeru).....	19
Po instalaci.....	21
Internet není dostupný.....	21
Linksys Smart Wi-Fi se neotevře ve vašem webovém prohlížeči .....	22
Technické údaje .....	23
Linksys EA8300 .....	23
Prostředí.....	23



# Přehled produktu

## Horní pohled

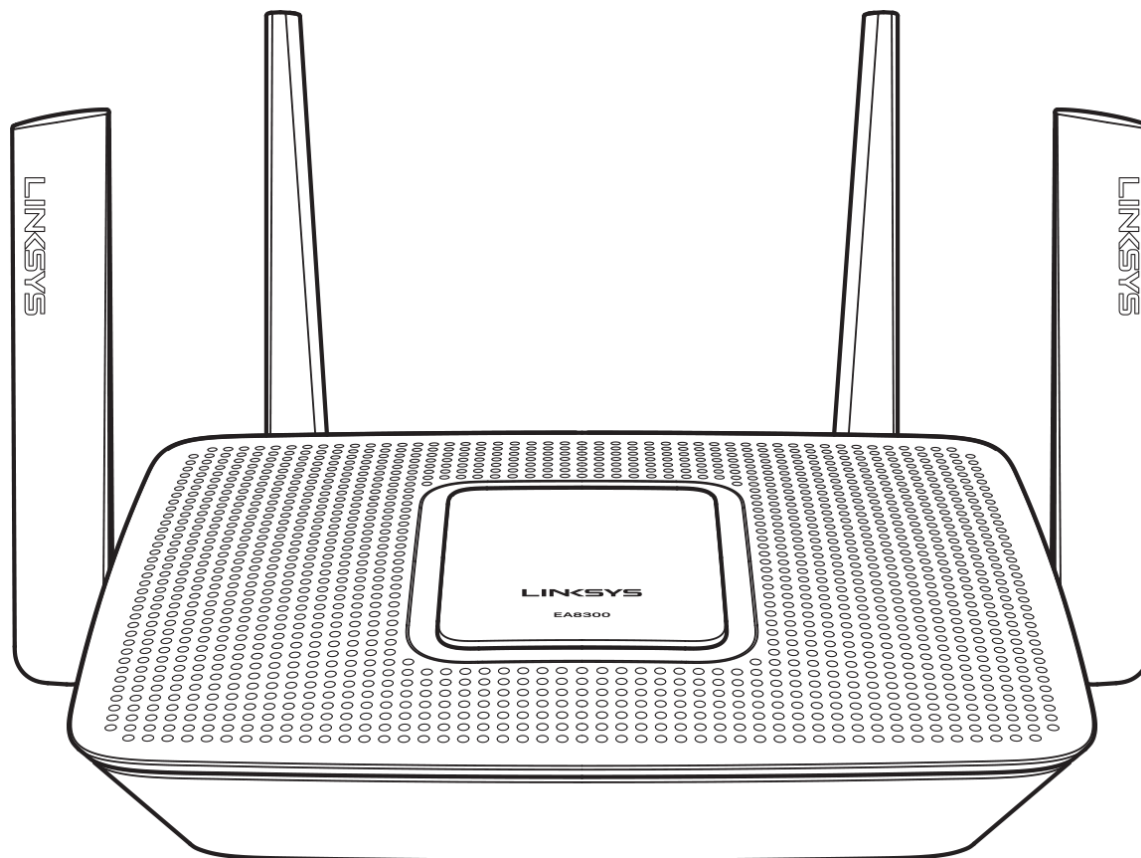

## Indikátor stavu baterie

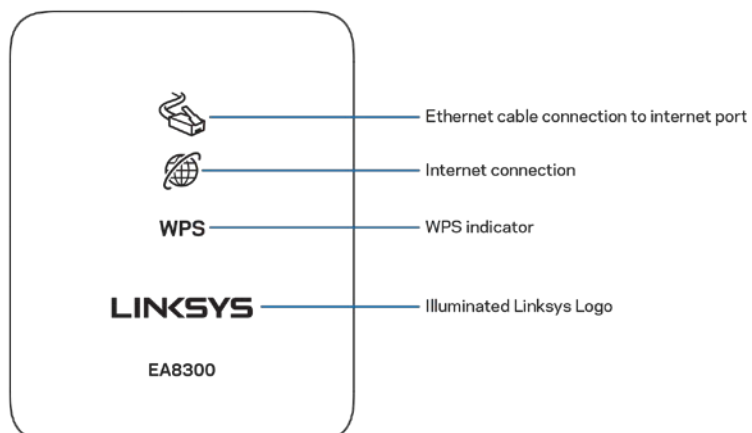

**Připojení síťového kabelu k internetovému portu** - pokud svítí (oranžově), značí to problém se síťovým kabelem připojeným k internetovému portu (WAN).

**Připojení k internetu** - pokud svítí (oranžově), znamená to, že router nemůže přistupovat k internetu.

**Indikátor WPS (Wi-Fi Protected Setup™)** - indikátor WPS má čtyři stavy:

<b>Vypnuto</b>	Nečinnost Wi-Fi Protected Setup
<b>Bliká bíle</b>	Probíhá Wi-Fi Protected Setup
<b>Svítí nepřerušovaně bíle</b>	Úspěch Wi-Fi Protected Setup; zůstane svítit pět sekund
<b>Bliká oranžově</b>	Chyba Wi-Fi Protected Setup; bliká minutu, pak zhasne

**Osvětlené logo Linksys** - logo **bliká**, když se router spouští. Pokud logo svítí nepřerušovaně bíle, router je napájen a pracuje správně.

## Zadní pohled

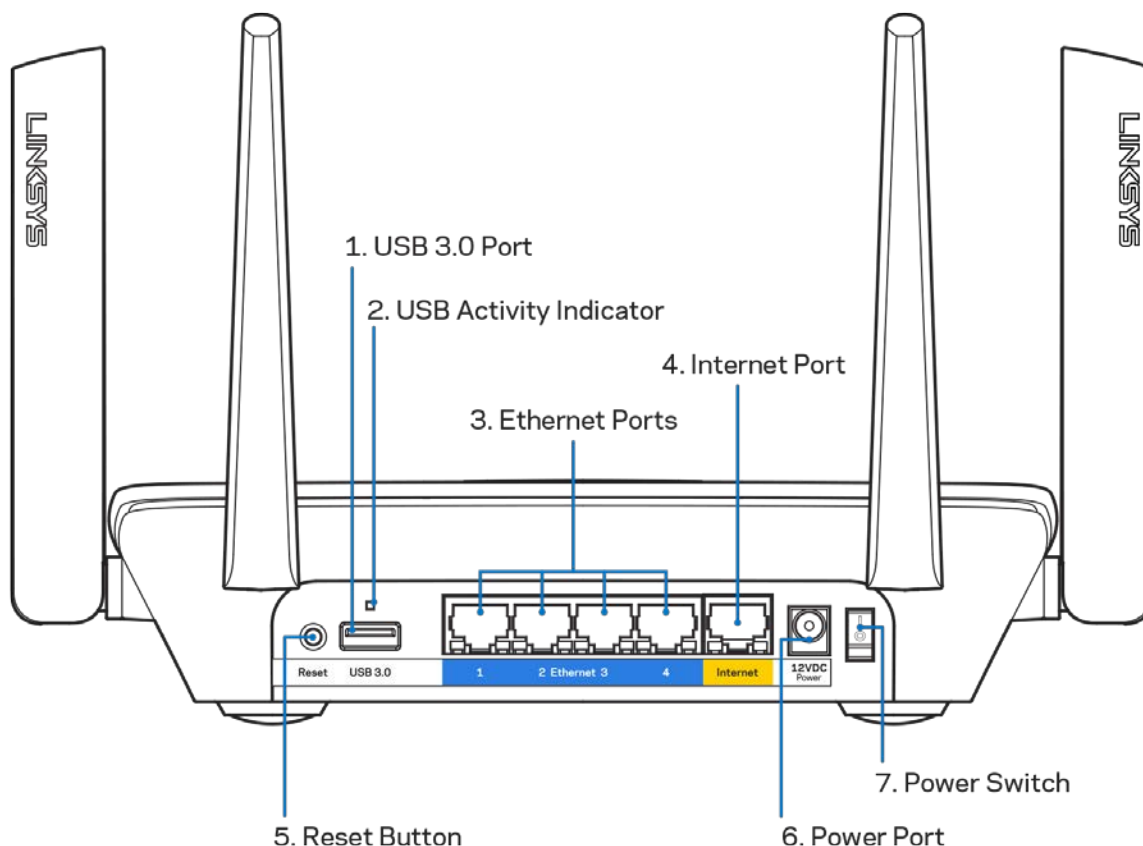

**Port USB 3.0 (1)** – připojte a sdílejte jednotky USB ve své síti nebo na internetu.

Indikátor činnosti **USB (2)** – **indikátory značí přenos dat** do externího zařízení či opačným směrem.

**Ethernetové porty (3)** – ethernetové (síťové) kabely připojte k těmto modrým gigabitovým portům (10/100/1000) a ke kabelovým zařízením v síti.

Poznámka – nejlepšího výkonu dosáhnete, pokud do ethernetových portů zapojíte kabely CAT5e nebo vyšší kategorie.

**Internetový port (4)** – ethernetový kabel připojte k tomuto žlutému gigabitovému portu (10/100/1000) a k modemu širokopásmového kabelového internetu/DSL nebo modemu optického internetového připojení.

*Poznámka - nejlepšího výkonu dosáhnete, pokud do ethernetových portů zapojíte kabely CAT5e nebo vyšší kategorie.*

**Resetovací tlačítko (5)** – stiskněte a podržte, dokud osvětlené logo Linksys nepřestane blikat, aby router obnovil své tovární nastavení. Tovární nastavení můžete obnovit také pomocí Linksys Smart Wi-Fi přes internet nebo mobilní aplikaci.

**Port napájení (6)** – připojte dodaný napájecí adaptér.

**Vypínač (7)** – stisknutím | (zap.) zapnete router.

## Boční pohled

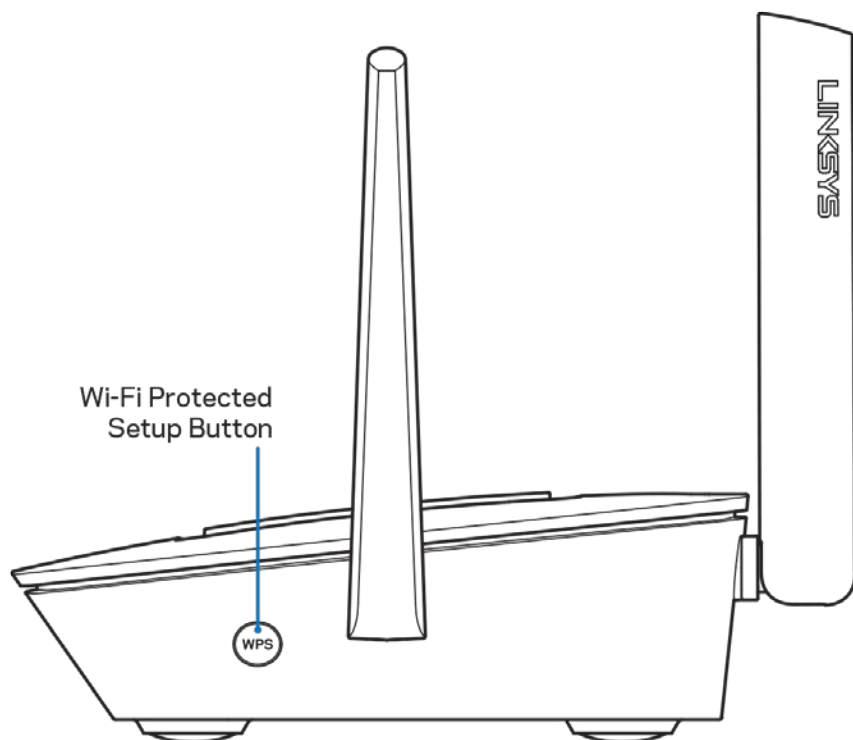

Tlačítko **Wi-Fi Protected Setup™** - stisknutím připojíte síťová zařízení s aktivním WPS.

# Instalace: Základy

## Kde získáte další pomoc

Kromě této uživatelské příručky najdete nápovědu na těchto místech:

- [Linksys.com/support/EA8300](http://Linksys.com/support/EA8300) (dokumentace, soubory ke stažení, časté dotazy, technická podpora, živý chat, fóra)
- Nápověda k Linksys Smart Wi-Fi (připojte se k Linksys Smart Wi-Fi, klepněte na Help (Nápověda) nahoře na obrazovce)

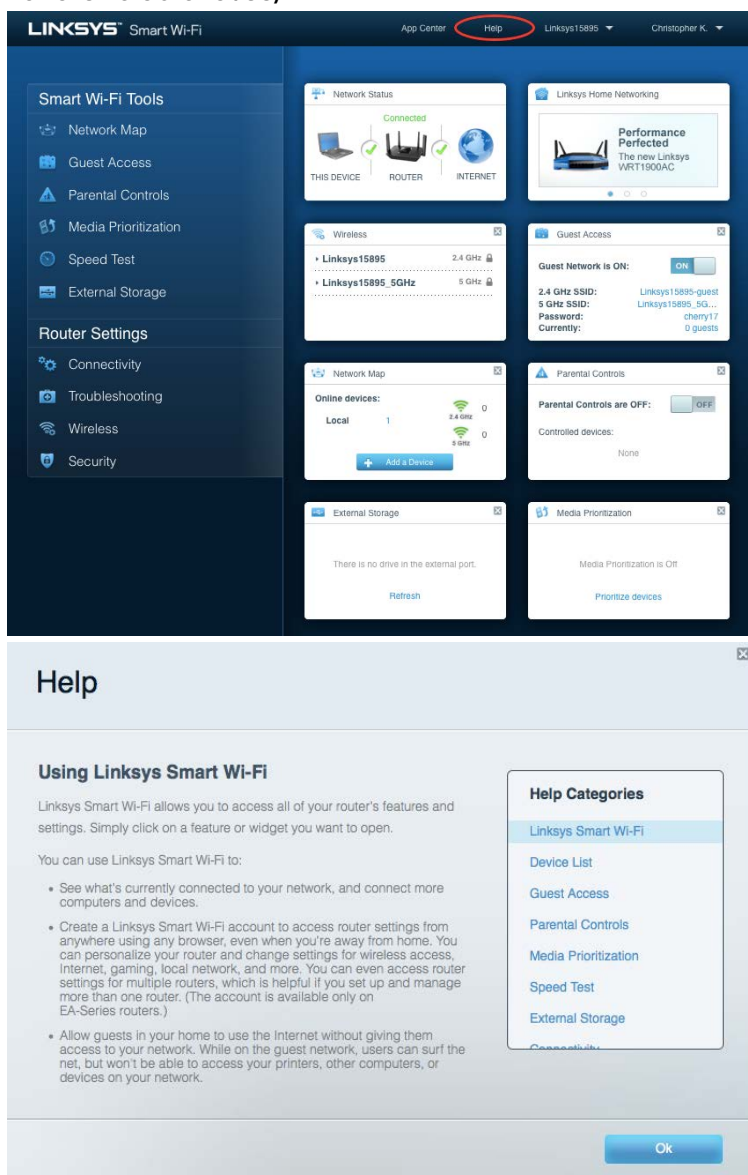

**Poznámka** - licence a informace pro software třetích stran použitý v tomto produktu jsou k dispozici na stránce <http://support.linksys.com/en-us/license>. V případě dotazů a žádostí o zdrojový kód pod licencí GPL se obraťte na <http://support.linksys.com/en-us/gplcodecenter>.

## Postup instalace routeru

1. K dokončení instalace potřebujete počítač s webovým prohlížečem, ve kterém navštívíte <http://LinksysSmartWiFi.com>.
2. Identifikujte své vybavení.

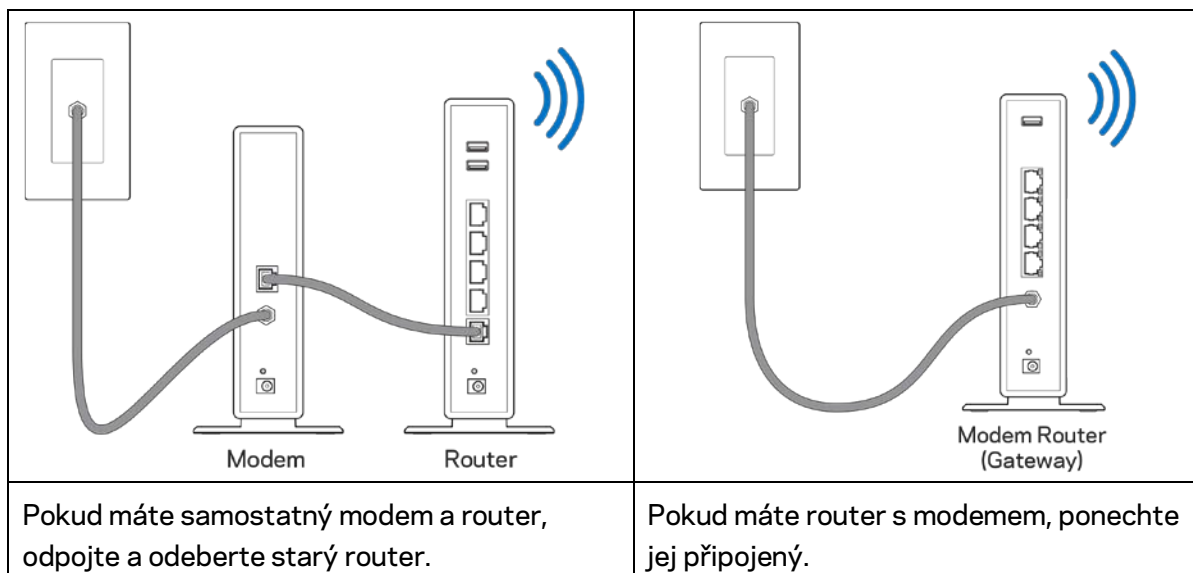

3. Umístěte antény tak, aby směřovaly přímo nahoru, a zapojte router ke zdroji napájení. Zkontrolujte, zda je vypínač v pozici | (zapnuto).
4. Připojte router k modemu nebo k routeru s modemem. Zapojte jeden konec dodaného internetového kabelu ke žlutému internetovému portu na novém routeru. Pokud máte modem, zapojte druhý konec do ethernetového portu (LAN) na modemu. Pokud máte router s modemem, zapojte je do volného portu.
5. Vyčkejte, až osvětlený indikátor Linksys nahoře na routeru přestane blikat a začne nepřerušovaně bíle svítit.
6. Připojte se k bezdrátové síti s názvem zobrazeným v Úvodní příručce, která byla dodána s vaším routerem. (Tyto údaje můžete později změnit.) Pokud potřebujete pomoc s připojením zařízení k síti, podívejte se do dokumentace na stránce [linksys.com/support/EA8300](http://linksys.com/support/EA8300).

**Poznámka - přístup k internetu nebude k dispozici, dokud nedokončíte nastavení routeru.**

7. Do webového prohlížeče zadejte <http://LinksysSmartWiFi.com>. Dokončete instalaci routeru podle instrukcí na obrazovce. Nastavení zahájíte také zadáním 192.168.1.1 do prohlížeče.

Na konci instalace postupujte podle pokynů na obrazovce a vytvořte si účet Linksys Smart Wi-Fi. Pomocí Linksys Smart Wi-Fi nakonfigurujte router z libovolného počítače s internetovým připojením.

Správa nastavení routeru:

- Změna názvu a hesla routeru
- Nastavení přístupu hosta
- Konfigurace rodičovské kontroly
- Připojení zařízení k vaší bezdrátové síti
- Testování rychlosti připojení k internetu

**Poznámka:** V rámci nastavování účtu Linksys Smart Wi-Fi obdržíte ověřovací e-mail. V domácí síti klepněte na odkaz v e-mailu, abyste router propojili s účtem Linksys Smart Wi-Fi.

**Tip:** Vytiskněte si tuto stránku a zaznamenejte si nastavení routeru a účtu do tabulky níže jako referenci. Uložte si poznámky na bezpečné místo.

Název sítě Wi-Fi 2,4 GHz	
Heslo Wi-Fi	
Název sítě Wi-Fi 5 GHz <sub>1</sub>	
Heslo Wi-Fi	
Název sítě Wi-Fi 5 GHz <sub>2</sub>	
Heslo Wi-Fi	
Heslo routeru	
Název sítě Wi-Fi 2,4 GHz pro hosty	
Název sítě Wi-Fi 5 GHz pro hosty	
Heslo sítě Wi-Fi pro hosty (obě sítě sdílejí heslo)	
Uživatelské jméno k Linksys Smart Wi-Fi	
Heslo k Linksys Smart Wi-Fi	



# Jak používat Linksys Smart Wi-Fi

Router můžete spravovat z libovolného místa pomocí Linksys Smart Wi-Fi, ale také přímo ze své domácí sítě. Linksys Smart Wi-Fi může být k dispozici také pro vaše mobilní zařízení. Další informace najdete v obchodě s aplikacemi ke svému zařízení.

## Připojení k Linksys Smart Wi-Fi

Připojení k Linksys Smart Wi-Fi:

1. Otevřete webový prohlížeč v počítači.
2. Přejděte na stránku <http://LinksysSmartWiFi.com> a přihlaste se ke svému účtu.

Linksys Smart Wi-Fi Sign In

If you have not yet created a Linksys Smart Wi-Fi account, click the "Create Account" button in the upper right corner of the page.

Give guests Internet access

Use your Linksys Smart Wi-Fi account to access your home network from anywhere, at any time, even from your mobile device. Easily connect new devices, set parental controls, get access to Smart Wi-Fi mobile Apps, and more.

For more information [click here](#)

English (United States)

For local access, [click here](#).

Pokud si nedokážete vybavit heslo, klepněte na *Forgot your password?* (Zapomněli jste heslo?) a obnovte si heslo podle pokynů na obrazovce.

## Mapa sítě

Můžete prohlížet a spravovat veškerá síťová zařízení připojená k routeru. Můžete sledovat zařízení v hlavní síti i v síti pro hosty, a zobrazit informace o každém zařízení.



## Přístup s právy hosta

Umožňuje nastavit a monitorovat síť pro hosty, a nabízet tak přístup k Wi-Fi bez odhalování osobních údajů.

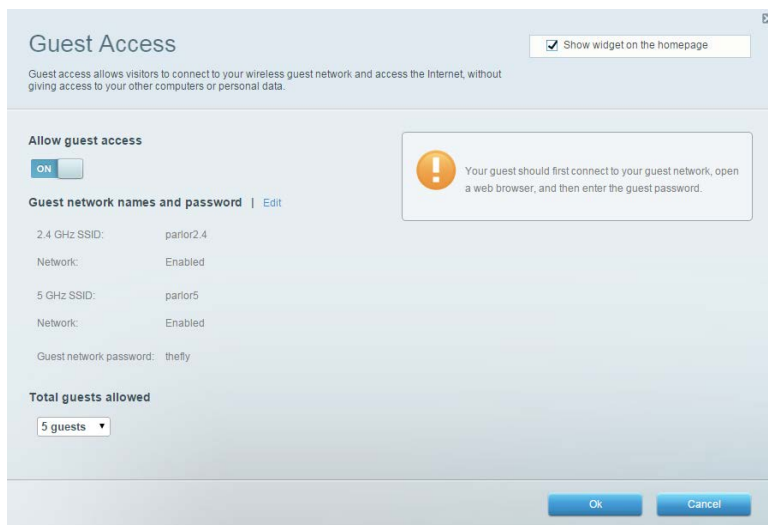

## Rodičovská kontrola

Umožňuje blokovat webové stránky a nastavit dobu přístupu k internetu.

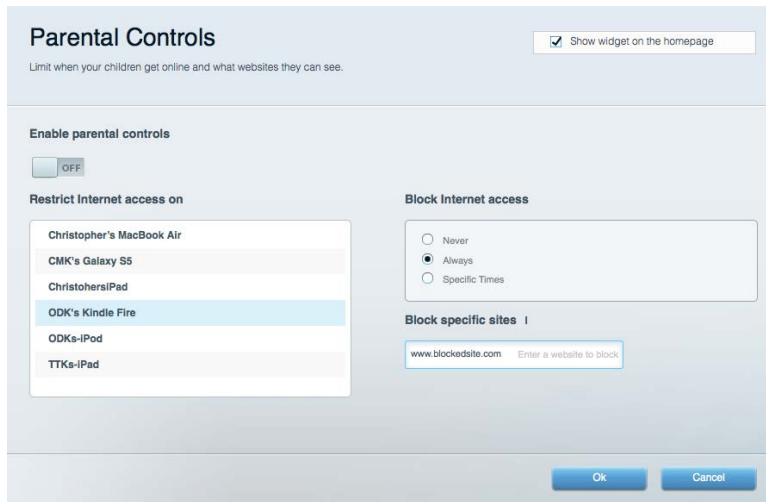

## Priorita médií

Umožňuje nastavit, která zařízení a aplikace mají nejvyšší prioritu pro váš síťový provoz.

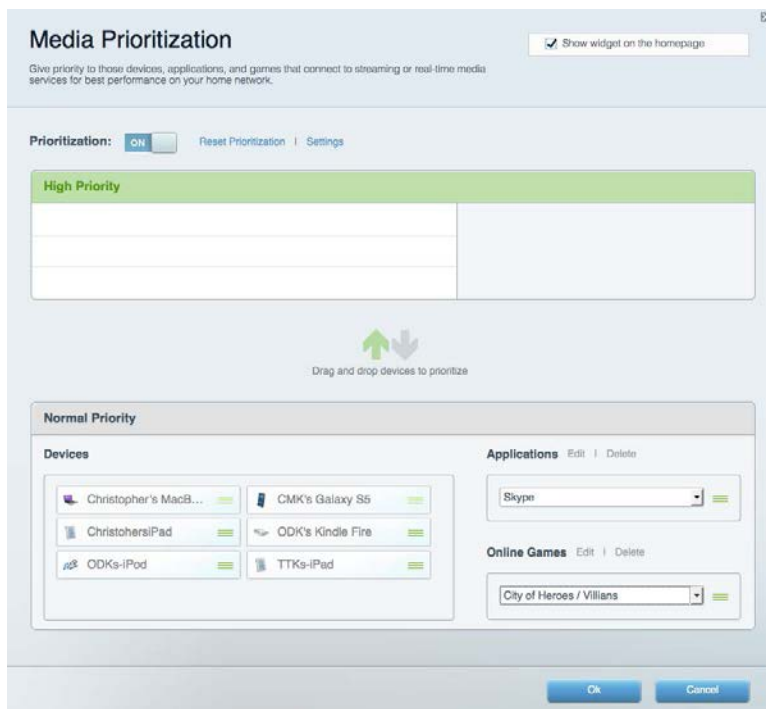

## Test rychlosti

Umožňuje otestovat rychlost internetového připojení vaší sítě.



## Externí úložiště

Umožňuje přistupovat k připojeným jednotkám USB a nastavovat sdílení souborů, mediální servery a přístup FTP.



## Připojení

Umožňuje zobrazovat a měnit základní i rozšířená síťová nastavení.

The screenshot shows the 'Connectivity' settings page of a router. It features a navigation bar with tabs for 'Basic', 'Internet Settings', 'Local Network', 'Advanced Routing', 'VLAN', and 'Administration'. The 'Internet Settings' tab is active. The page is divided into several sections: 'Network Name and Password' with fields for 2.4 GHz and 5 GHz network names and passwords; 'Router Password' with a masked password field; 'Router Firmware Update' with a checked 'Automatic' option and a 'Check for Updates' button; 'Time Zone' with a dropdown menu set to '(GMT-05:00) Eastern Time (USA & Canada)' and a checked 'Automatically adjust for Daylight Savings Time' option; and 'Activity Lights' with an 'ON' toggle and a descriptive text box. At the bottom, there are 'Ok', 'Cancel', and 'Apply' buttons.

## Odstraňování problémů

Umožňuje diagnostikovat problémy s routerem a kontrolovat stav sítě.

The screenshot shows the 'Troubleshooting' settings page of a router. It features a navigation bar with tabs for 'Status', 'Diagnostics', and 'Logs'. The 'Diagnostics' tab is active. The page is divided into several sections: 'Ping IPv4' with input fields for IP or host name and number of pings, and a 'Start to Ping' button; 'Trace route' with an input field for IP or host name and a 'Start to Traceroute' button; 'Reboot' with a 'Reboot the router' link; 'Router configuration' with 'Backup' and 'Restore' buttons; 'Router Firmware' with a 'Restore previous firmware' button; 'Internet Address' showing IPv4 (10.0.0.253) and IPv6 (2601:0540::000:0019:0000:0000:0000:314e) addresses with 'Release and Renew' links; and 'Factory reset' with a 'Reset to factory default settings' link. An 'Ok' button is located at the bottom right.

## Bezdrátové připojení

Umožňuje zobrazovat a měnit bezdrátovou síť routeru. Můžete měnit názvy sítě, režim zabezpečení, heslo, filtrování adres MAC a připojovat zařízení pomocí Wi-Fi Protected Setup™.

Wireless

View and change router settings

Wireless MAC Filtering Wi-Fi Protected Setup

Smart Connect:  5 GHz band steering  Off

Network name: arachnid 2.4 GHz Network: ON

Password: peterparker Broadcast SSID: Yes Channel: Auto

Security mode: WPA2/WPA Mixed Pt Network mode: Mixed Channel width: Auto

Network name: arachnid\_5GHz 5 GHz<sub>1</sub> + 5 GHz<sub>2</sub> Network: ON

Password: peterparker Broadcast SSID: Yes Channel: Auto

Security mode: WPA2/WPA Mixed Pt Network mode: Auto Channel width: Auto

Ok Cancel Apply

## Zabezpečení

Umožňuje zobrazovat a měnit bezdrátové zabezpečení routeru. Můžete nainstalovat firewall, nastavit VPN a vytvářet vlastní nastavení pro aplikace a hry.

Security

View and change router settings

Firewall DMZ Apps and Gaming

Firewall

IPv4 SPI firewall protection  Enabled

IPv6 SPI firewall protection  Enabled

VPN Passthrough

IPSec Passthrough  Enabled

PPTP Passthrough  Enabled

L2TP Passthrough  Enabled

Internet filters

Filter anonymous Internet requests

Filter multicast

Filter Internet NAT redirection

Filter ident (Port 113)

IPv6 Port Services

Description	Protocol	IPv6 Address	Allow	Enabled

Add IPv6 Firewall Setting

Ok Cancel Apply

# Odstraňování problémů

Další nápovědu najdete v naší oceňované zákaznické podpoře na stránce [linksys.com/support/EA8300](https://linksys.com/support/EA8300).

## Váš router nebyl úspěšně nainstalován

Pokud Linksys Smart Wi-Fi nedokončí instalaci, můžete zkusit následující:

- Stiskněte a podržte resetovací tlačítko na routeru sponkou na papír nebo špendlíkem, dokud osvětlené logo Linksys nezhasne a modré indikátory MU-MIMO nepřestanou blikat (přibližně 10 sekund). Nainstalujte router znovu.

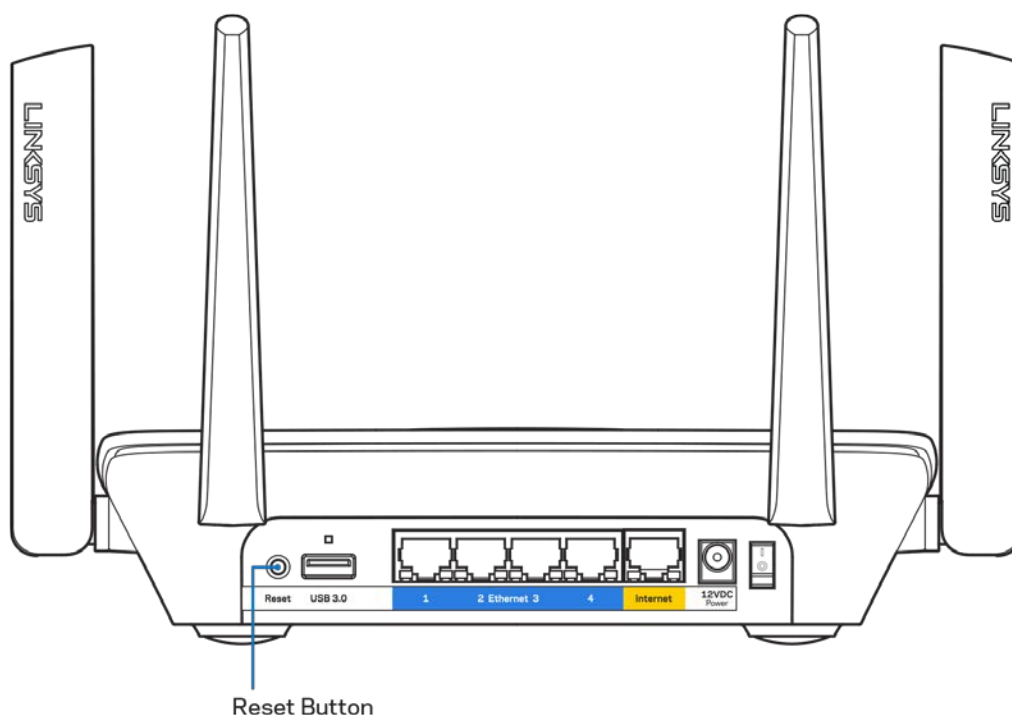

- Deaktivujte dočasně bránu firewall počítače (nápovědu najdete v pokynech k bezpečnostnímu softwaru). Nainstalujte router znovu.
- Pokud máte jiný počítač, použijte jej a nainstalujte router znovu.

## Zpráva „Your Internet cable is not plugged“ (Internetový kabel není připojen)

Pokud se při nastavování routeru zobrazí zpráva „Your Internet cable is not plugged“ (Internetový kabel není připojen), postupujte podle těchto pokynů.

- Zkontrolujte, zda je ethernetový nebo internetový kabel (nebo kabel dodaný s routerem) pevně připojený ke žlutému internetovému portu na zadní straně routeru a ke správnému portu modemu. Tento port je na modemu obvykle označený jako Ethernet.

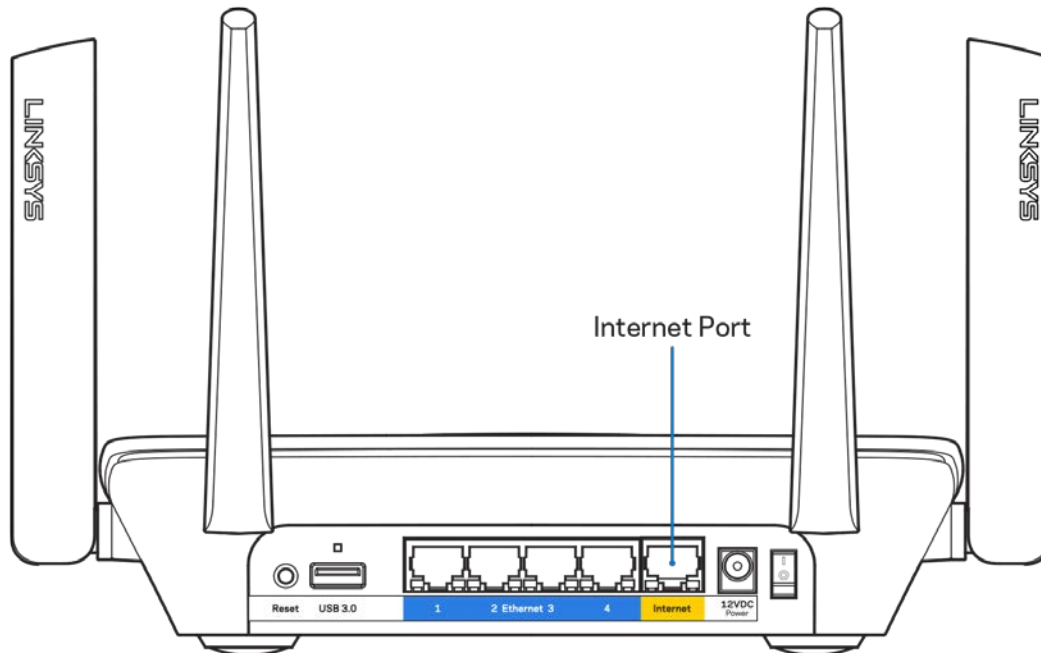

- Zkontrolujte, zda je modem připojený k napájení a zapnutý. Pokud má vypínač, zkontrolujte, že je nastavený v pozici ON (zap.) nebo I (protiklad O).

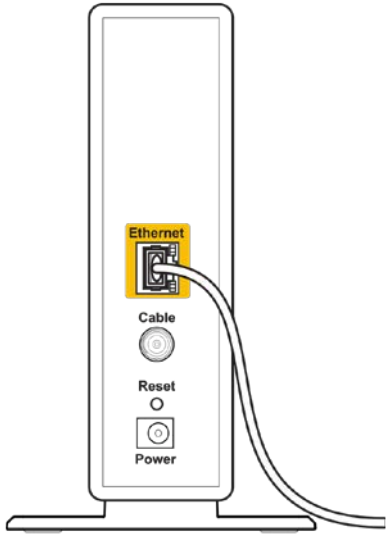
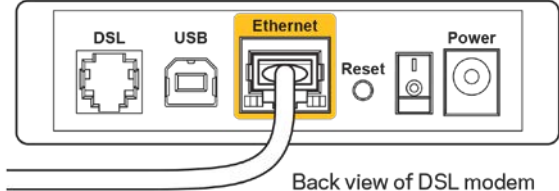

 <p>Back view of cable modem</p>	 <p>Back view of DSL modem</p>
<p>Pokud používáte kabelové připojení k internetu, zkontrolujte, zda je kabelový port (CABLE) připojený ke koaxiálnímu kabelu od vašeho poskytovatele připojení internetu.</p>	<p>Pokud používáte internetové připojení DSL, zkontrolujte, zda je vaše telefonní linka DSL připojená k portu DSL.</p>

- Pokud byl váš počítač připojen k modemu kabelem USB, odpojte tento kabel USB.
- Nainstalujte router znovu.

## ***Zpráva „Cannot access your router“ (Nelze přistupovat k routeru)***

Chcete-li přistupovat k routeru, musíte být připojeni k vlastní síti. Pokud se k internetu připojujete bezdrátově, možná jste se omylem připojili k jiné bezdrátové síti.

Postup řešení problému na počítačích se systémem Windows\*:

1. Klepněte na ikonu bezdrátové sítě na hlavním panelu. Zobrazí se seznam dostupných sítí.

2. Klepněte na název své sítě. Klepněte na Připojit. V příkladu níže byl počítač připojen k jiné bezdrátové síti s názvem wraith\_5GHz. Zobrazí se název vybrané bezdrátové sítě routeru Linksys EA8300, v příkladu je vybrán název Damaged\_Beez2.4.



3. Pokud se zobrazí výzva, abyste zadali síťový klíč, zadejte heslo (bezpečnostní klíč) do pole pro bezpečnostní klíč. Klepněte na OK.
4. Váš počítač se připojí k síti a měli byste být schopni přistupovat k routeru.

*\*V závislosti na verzi Windows mohou existovat rozdíly v textu či ikonách obsažených v tomto postupu.*

Postup řešení problému v počítačích se systémem Mac:

1. V panelu nabídek nahoře na obrazovce klepněte na ikonu Wi-Fi. Zobrazí se seznam bezdrátových sítí.
2. V příkladu níže byl počítač připojen k jiné bezdrátové síti s názvem wraith\_5GHz. Zobrazí se název vybrané bezdrátové sítě routeru Linksys EA8300, v příkladu je vybrán název Damaged\_Beez2.4.

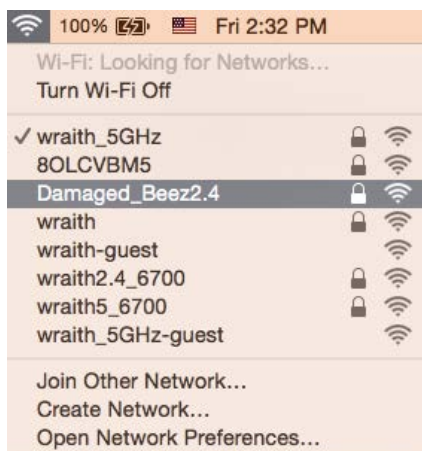

3. Klepněte na název bezdrátové sítě vašeho routeru Linksys EA8300 (v příkladu `Damaged_Beez2.4`).
4. Zadejte heslo bezdrátové sítě (bezpečnostní klíč) do pole *Password (Heslo)*. Klepněte na OK.

## Po instalaci

### Internet není dostupný

Pokud nastane problém v komunikaci internetu s vaším routerem, může se ve webovém prohlížeči zobrazit zpráva „Cannot find [Internet address]“ (Nelze najít [internetovou adresu]). Pokud víte, že je internetová adresa správná, a pokud jste vyzkoušeli více internetových adres se stejným výsledkem, zpráva by mohla značit, že nastal problém u poskytovatele připojení k internetu nebo v modemu, který komunikuje s routerem. Zkuste:

- Zkontrolujte, že jsou síťové a napájecí kabely bezpečně připojené.
- Zkontrolujte, že elektrická zásuvka, ke které je router připojený, dodává napájení.
- Restartujte router.
- Kontaktujte poskytovatele připojení k internetu a dotežte se na výpadky ve vaší oblasti.

Nejčastějším řešením je vypnutí a zapnutí routeru. Váš router poté může znovu načíst vlastní nastavení. Ostatní zařízení (například modem) router detekují a začnou s ním znovu komunikovat. Tento proces se nazývá restartování.

Chcete-li restartovat router pomocí napájecího kabelu, postupujte takto:

1. Odpojte napájecí kabel od routeru a modemu.
2. Počkejte 10 sekund a pak znovu připojte napájecí kabel k modemu. Zkontrolujte, že má napájení.
3. Vyčkejte, dokud online indikátor modemu nepřestane blikat (přibližně dvě minuty). Připojte napájecí kabel zpět k routeru.
4. Vyčkejte, dokud se nerozsvítí osvětlené logo Linksys. Vyčkejte dvě minuty, než se pokusíte připojit počítač k internetu.

Restartování routeru pomocí Linksys Smart Wi-Fi:

1. Přihlaste se k Linksys Smart Wi-Fi. (Viz „Připojení k Linksys Smart Wi-Fi“ na straně [11](#).)
2. V části *Router Settings* (Nastavení routeru) klepněte na *Troubleshooting* (Odstraňování problémů).
3. Klepněte na kartu *Diagnostics* (Diagnostika).

4. V části *Reboot (Restartovat)* klepněte na Reboot (Restartovat).



5. Klepněte na „Yes“ (Ano). Router se restartuje. Když se router restartuje, všechna připojená zařízení ztratí připojení k internetu, a znovu se automaticky připojí, až bude router opět připraven.

## Linksys Smart Wi-Fi se neotevře ve vašem webovém prohlížeči

Poslední verze Google Chrome™, Firefox®, Safari® (pro Mac® a iPad®), Microsoft Edge a Internet Explorer® verze 8 a novější fungují s Linksys Smart Wi-Fi.

# Technické údaje

## Linksys EA8300

Název modelu	Třípásmový router Max-Stream AC2200 MU-MIMO
Číslo modelu	EA8300
Rychlost přepínaných portů	10/100/1000 Mb/s (gigabitový ethernet)
Frekvence vysílání	2,4 GHz a 5 GHz (x2)
Počet antén	4 externích nastavitelných antén (neodnímatelné)
Porty	USB 3.0, ethernet (1-4), internet, napájení
Tlačítka	Wi-Fi Protected Setup, napájení, reset
Indikátory	<b>Horní panel:</b> Osvětlené logo Linksys, Wi-Fi Protected Setup, připojení k internetu, připojení síťového kabelu k internetovému portu <b>Zadní panel:</b> USB, ethernet (1-4), internet
UPnP	Podporované
bezpečnostní funkce	WEP, WPA2, RADIUS
Úroveň zabezpečení	Až 128bitové šifrování
Podpora systému souborů úložiště	FAT, NTFS a HFS+
Podpora prohlížečů	Nejnovější verze Google Chrome™, Firefox®, Safari® (pro Mac® a iPad®), Microsoft Edge a Internet Explorer® verze 8 a novější

## Prostředí

Rozměry	213,7mm x 161,8mm x 54,8mm (bez antén)
Hmotnost	608 g
Napájení	12 V, 2A
Certifikace	FCC, IC, CE, Wi-Fi (a/b/g/n/ac)
Provozní teplota	0 až 40 °C (32 až 104 °F)
Skladovací teplota	-20 až 60 °C (-4 až 140 °F)
Provozní vlhkost	10% až 80% relativní vlhkost, bez kondenzace
Skladovací vlhkost	5% až 90% bez kondenzace

Specifikace podléhají změně bez oznámení.

Poznámky:

Regulační, záruční a bezpečnostní informace najdete na disku CD, který byl dodán s routerem, nebo navštivte stránku [Linksys.com/support/EA8300](http://Linksys.com/support/EA8300).

Maximální výkon je odvozen od specifikací standardu IEEE 802.11. Skutečný výkon se může lišit, a to včetně nižší kapacity bezdrátové sítě, rychlosti přenosu dat, dosahu a pokrytí sítě. Výkon závisí na mnoha faktorech, podmínkách a proměnných, včetně vzdálenosti od přístupového bodu, intenzity síťového provozu, stavebních materiálů a konstrukcí, použitého operačního systému, kombinace používaných bezdrátových produktů, rušení atd.

BELKIN, LINKSYS a řada názvů produktů, značek a log jsou ochranné známky skupiny společností Belkin. Zmíněné ochranné známky třetích stran jsou vlastnictvím příslušných vlastníků. Licence a informace pro software třetích stran použitý v tomto produktu jsou k dispozici zde:

<http://support.linksys.com/en-us/license>. V případě dotazů a žádostí o zdrojový kód pod licencí GPL se obraťte na <http://support.linksys.com/en-us/gplcodecenter>.

© 2017 Belkin International, Inc. a/nebo její dceřiné společnosti. Všechna práva vyhrazena.

**LINKSYS®**

Brugervejledning

**MAX-STREAM™  
AC2200 MU-MIMO  
TRI-BAND ROUTER**

Model EA8300

# Indhold

Produktoverblik .....	3
Set fra oven .....	3
Systemets statuslamper .....	4
Set bagfra .....	5
Set fra siden .....	6
Installation: Grundlæggende .....	7
Hvor finder jeg mere hjælp? .....	7
Installation af routeren .....	8
Brug af Linksys Smart Wi-Fi .....	11
Oprettelse af forbindelse til Linksys Smart Wi-Fi .....	11
Netværksoversigt .....	12
Gæst adgang .....	12
Forældrekontrol .....	13
Prioritering af båndbredde .....	13
Test af hastighed .....	14
Ekstern lagring .....	14
Tilslutning .....	15
Fejlfinding .....	15
Trådløs .....	16
Sikkerhed .....	16
Fejlfinding .....	17
Routeren er ikke installeret rigtigt .....	17
Meddelelsen <i>Internetledning ikke tilsluttet</i> .....	18
Meddelelsen <i>Ingen adgang til routeren</i> .....	19
Efter installationen .....	21
Internettet ser ud til ikke at være tilgængeligt .....	21
Linksys Smart Wi-Fi åbner ikke i browseren .....	22
Specifikationer .....	23
Linksys EA8300 .....	23
Omgivelser .....	23



# Produktoverblik

Set fra oven

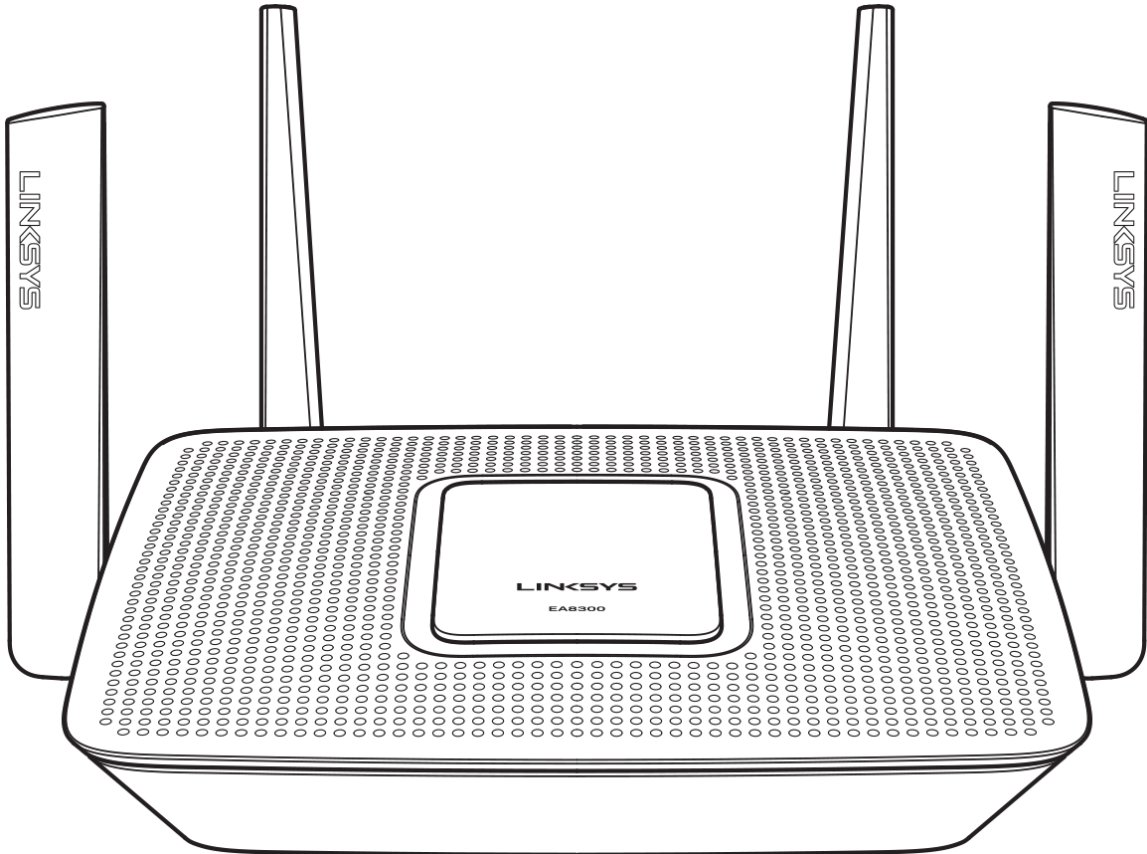

## Systemets statuslamper

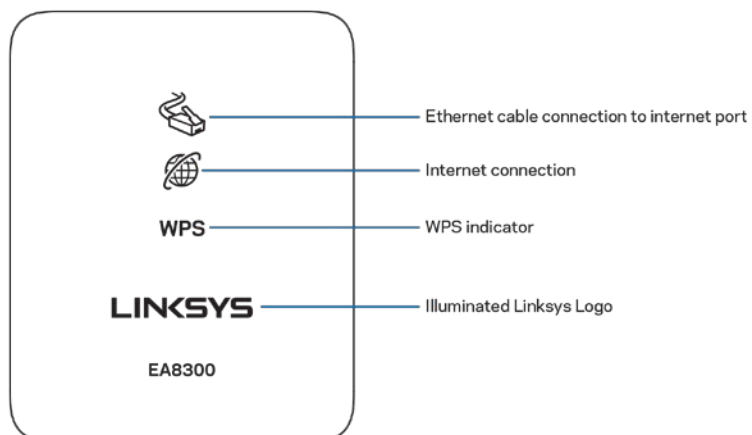

**Ethernet-ledningstilslutning til internetport:** Hvis lampen lyser (orange), er der et problem med netværksledningen, som er tilsluttet i internetporten (WAN).

**Internetforbindelse:** Hvis lampen lyser (orange), har routeren ikke forbindelse til internettet.

**WPS-lampe (Wi-Fi Protected Setup™):** WPS-lampen har 4 statusindikationer:

<b>Slukket</b>	Ingen Wi-Fi Protected Setup-aktivitet
<b>Blinker hvidt</b>	Wi-Fi Protected Setup i gang
<b>Konstant hvidt</b>	Wi-Fi Protected Setup fuldført; lyser i 5 sekunder
<b>Blinker orange</b>	Fejl ved Wi-Fi Protected Setup; blinker i 1 minut og slukker derefter

**Lysende Linksys logo:** Blinker, mens routeren starter. Når logoet lyser konstant hvidt, er routeren tændt og fungerer korrekt.

## Set bagfra

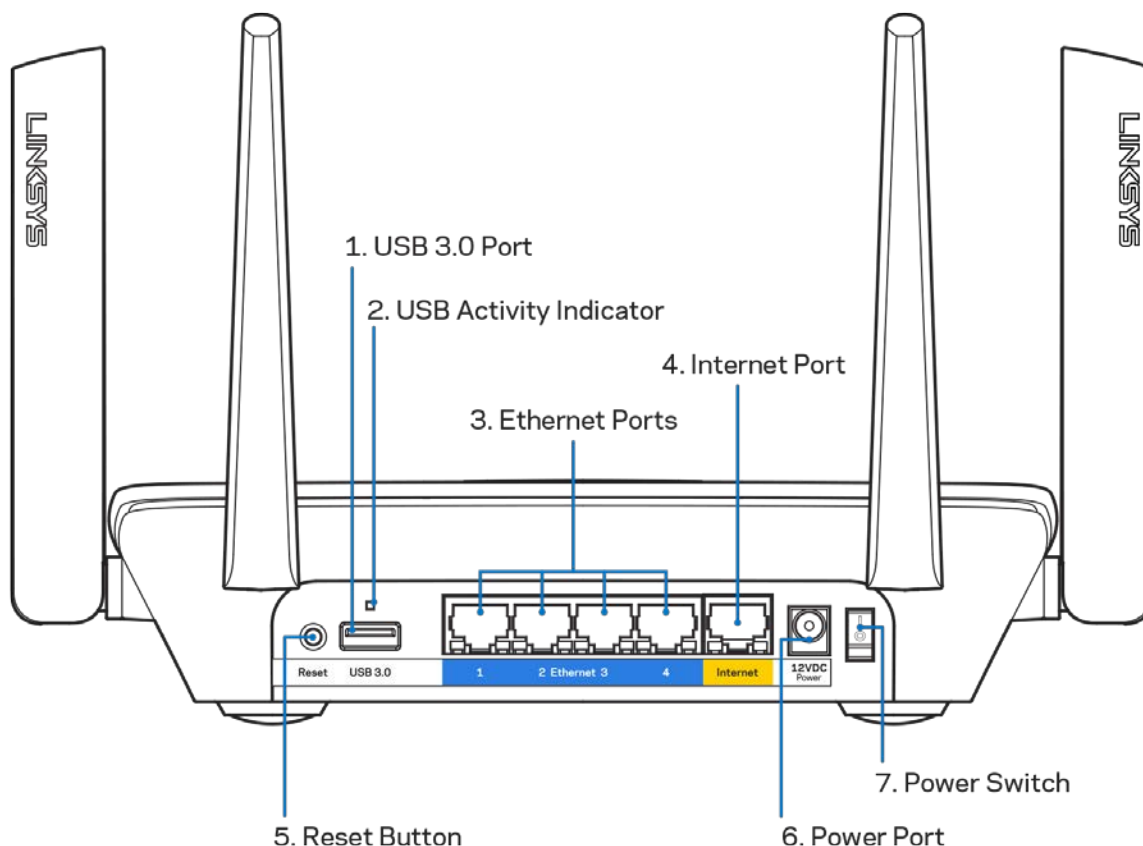

**USB 3.0 port (1):** Tilslut USB-drev og del dem med andre på dit netværk eller på internettet.

Lampe for **USB-aktivitet (2):** Lyser, når der overføres data til/fra eksterne enheder.

Ethernet-porte (3): Tilslut Ethernet-ledninger i disse blå Gigabit-porte (10/100/1000) og til kablede enheder i netværket.

**Bemærk:** Brug CAT5e-ledninger eller ledninger med en højere mærkeeffekt til Ethernet-portene for optimal funktion.

**Internetport (4):** Tilslut en Ethernet-ledning i denne gule Gigabit-port (10/100/1000) og i et bredbåndsmodem med ledning/DSL eller fibernet.

**Bemærk:** Brug CAT5e-kabler eller bedre i internetporten for at opnå den bedste ydeevne.

**Nulstillingsknap (5):** Tryk på knappen og hold den inde, indtil det lysende Linksys logo slukker, for at nulstille routeren til fabriksindstillingerne. Fabriksindstillingerne kan også gendannes ved at bruge Linksys Smart Wi-Fi på internettet eller mobilappen.

Strømport (6) – Tilslut den medfølgende vekselstrømsadapter.

**Strømknap (7) –** Tryk på | (on) for at tænde routeren.

## Set fra siden

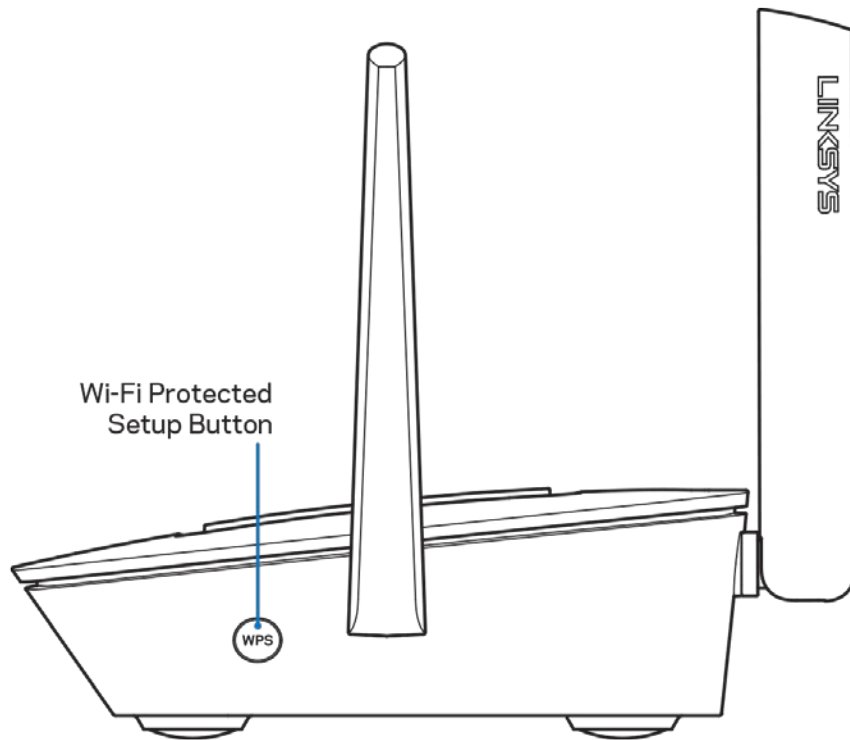

**Wi-Fi Protected Setup™ knap:** Tryk for at oprette forbindelse til WPS-kompatible netværksenheder.

# Installation: Grundlæggende

## Hvor finder jeg mere hjælp?

Ud over denne brugervejledning kan du finde hjælp her:

- [Linksys.com/support/EA8300](http://Linksys.com/support/EA8300) (dokumentation, download, spørgsmål/svar, teknisk support, chat, forummer)
- Hjælp til Linksys Smart Wi-Fi (tilslut til Linksys Smart Wi-Fi, og klik på Hjælp øverst i vinduet)

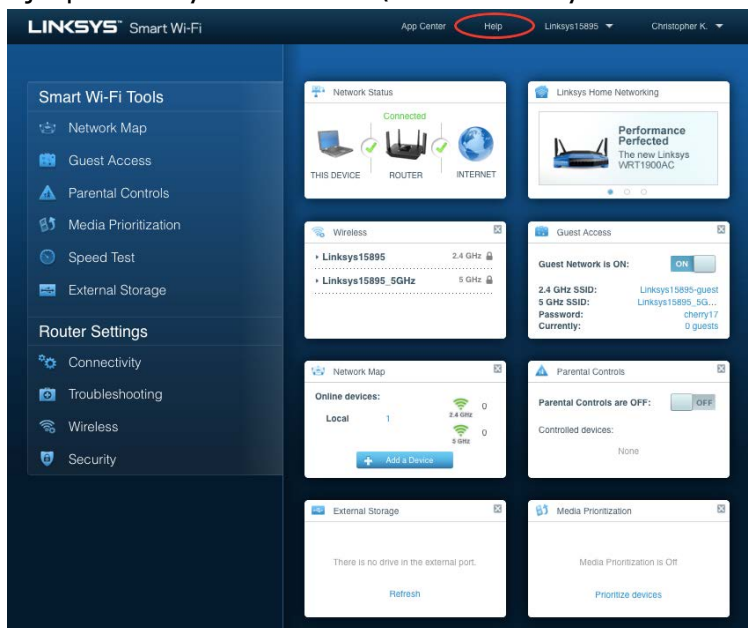

The screenshot shows the Linksys Smart Wi-Fi web interface. At the top, there is a navigation bar with 'App Center', 'Help' (highlighted with a red circle), 'Linksys15895', and 'Christopher K.'. The main content area is divided into several sections: 'Smart Wi-Fi Tools' (Network Map, Guest Access, Parental Controls, Media Prioritization, Speed Test, External Storage), 'Router Settings' (Connectivity, Troubleshooting, Wireless, Security), and various status widgets (Network Status, Linksys Home Networking, Wireless, Guest Access, Network Map, Parental Controls, External Storage, Media Prioritization). Below this, a 'Help' dialog box is open, displaying the title 'Using Linksys Smart Wi-Fi' and a list of 'Help Categories' including 'Linksys Smart Wi-Fi', 'Device List', 'Guest Access', 'Parental Controls', 'Media Prioritization', 'Speed Test', and 'External Storage'. An 'Ok' button is visible at the bottom of the dialog.

*Bemærk: Licenser og meddelelser vedrørende tredjepartssoftware, som anvendes i dette produkt, kan ses på <http://support.linksys.com/en-us/license>. Se <http://support.linksys.com/en-us/gplcodecenter>, hvis du har spørgsmål eller ønsker GPL-kildekode.*

## Installation af routeren

1. For at installere skal du bruge en computer og gå ind på <http://LinksysSmartWiFi.com> i en browser.
2. Identificer udstyret.

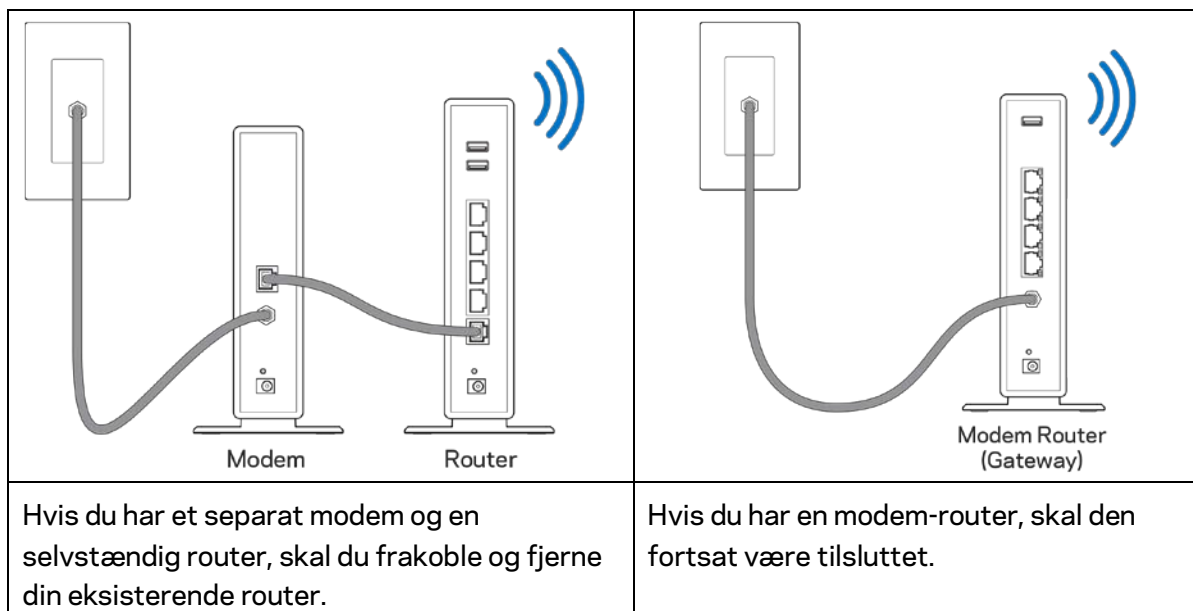

3. Placer antennerne lige opad, og tilslut routeren til en strømkilde. Tænd/sluk-knappen skal være i positionen | (on).
4. Tilslut routeren til modemmet eller modem-routeren. Tilslut stikket i den ene ende på den medfølgende internetledning i den gule internetport på den nye router. Hvis du har et modem, skal du sætte stikket i den anden ende i Ethernet-porten (LAN) på modemmet. Hvis du har en modem-router, kan stikket sættes i en vilkårlig ledig port.
5. Vent, indtil det lysende Linksys logo oven på routeren stopper med at blinke og lyser konstant hvidt.
6. Opret forbindelse til det trådløse netværksnavn, som ses i startvejledningen, der medfølger til routeren (du kan ændre disse oplysninger senere). Hvis du har brug for hjælp til at oprette forbindelse til netværket, kan du se dokumentationen til enheden på [linksys.com/support/EA8300](http://linksys.com/support/EA8300).

*Bemærk: Der er ikke adgang til internettet, før installationen af routeren er fuldført.*

7. Indtast <http://LinksysSmartWiFi.com> i en browser. Følg vejledningen på skærmen for at fuldføre installationen af routeren. Du kan også indtaste 192.168.1.1 i en browser for at starte installationen.

Når installationen er fuldført, skal du følge vejledningen på skærmen for at oprette din konto til Linksys Smart Wi-Fi. Du kan bruge Linksys Smart Wi-Fi til at konfigurere routeren via enhver computer med internetforbindelse.

Redigering af routerens indstillinger:

- Ændring af routerens navn og adgangskode
- Konfigurering af gæstegang
- Konfigurering af forældrekontrol
- Tilslutning af enheder til dit trådløse netværk
- Test af internetforbindelsens hastighed

**Bemærk:** Ved oprettelse af kontoen til Linksys Smart Wi-Fi får du tilsendt en bekræftende e-mail. På hjemmenetværket skal du klikke på linket i e-mailen for at knytte din router til din konto til Linksys Smart Wi-Fi.

**Tip:** Udskriv næste side, og noter dine router- og kontoindstillinger i skemaet nedenfor som reference. Læg de noterede indstillinger et sted, hvor du kan finde dem igen.

Navn på 2,4 GHz WiFi	
Wi-Fi adgangskode	
Navn på 5 GHz <sub>1</sub> Wi-Fi	
Adgangskode til Wi-Fi	
Navn på 5 GHz <sub>2</sub> Wi-Fi	
Adgangskode til Wi-Fi	
Adgangskode til router	
Navn på 2,4 GHz Wi-Fi til gæster	
Navn på 5 GHz Wi-Fi til gæster	
Adgangskode til Wi-Fi til gæster (begge har den samme adgangskode)	
Brugernavn til Linksys Smart Wi-Fi	
Adgangskode til Linksys Smart Wi-Fi	



# Brug af Linksys Smart Wi-Fi

Du kan administrere routeren hvor som helst fra i verden via Linksys Smart Wi-Fi, men du kan også gøre det direkte på dit hjemmenetværk. Der er desuden adgang til Linksys Smart Wi-Fi via mobilenheder. Se appbutikken til din mobilenhed for nærmere oplysninger.

## Oprettelse af forbindelse til Linksys Smart Wi-Fi

Sådan opretter du forbindelse til Linksys Smart Wi-Fi:

1. Åbn en browser på din computer.
2. Gå ind på <http://LinksysSmartWiFi.com>, og log på din konto.

Linksys Smart Wi-Fi Sign In

If you have not yet created a Linksys Smart Wi-Fi account, click the "Create Account" button in the upper right corner of the page.

Give guests Internet access

Use your Linksys Smart Wi-Fi account to access your home network from anywhere, at any time, even from your mobile device. Easily connect new devices, set parental controls, get access to Smart Wi-Fi mobile Apps, and more.

For more information [click here](#)

English (United States)

For local access, [click here](#).

Hvis du har glemt din adgangskode, skal du klikke på *Har du glemt din adgangskode?* og følge vejledningen på skærmen for at få den igen.

## Netværksoversigt

Her kan du se og holde styr på alle netværksenheder, der er tilsluttet routeren. Du kan se enheder på dit primære netværk og gæsternetværk eller se oplysninger om hver enkelt enhed.



## Gæstegang

Til at installere og overvåge et netværk til gæster, så de kan få trådløs adgang, uden at dine personlige data afsløres.

The screenshot shows a 'Guest Access' configuration window. At the top, there is a 'Show widget on the homepage' checkbox. Below this, the text reads: 'Guest access allows visitors to connect to your wireless guest network and access the Internet, without giving access to your other computers or personal data.' The main section is titled 'Allow guest access' and features a toggle switch set to 'ON'. To the right of this section is a warning box with an exclamation mark icon and the text: 'Your guest should first connect to your guest network, open a web browser, and then enter the guest password.' Below the toggle, there is a section for 'Guest network names and password' with an 'Edit' link. This section lists: '2.4 GHz SSID: parlor2.4', 'Network: Enabled', '5 GHz SSID: parlor5', and 'Network: Enabled'. The 'Guest network password' is listed as 'theyfly'. At the bottom, there is a 'Total guests allowed' section with a dropdown menu set to '5 guests'. 'Ok' and 'Cancel' buttons are at the bottom right.

## Forældrekontrol

Her kan du spærre websteder og indstille tidspunkter for adgang til internettet.

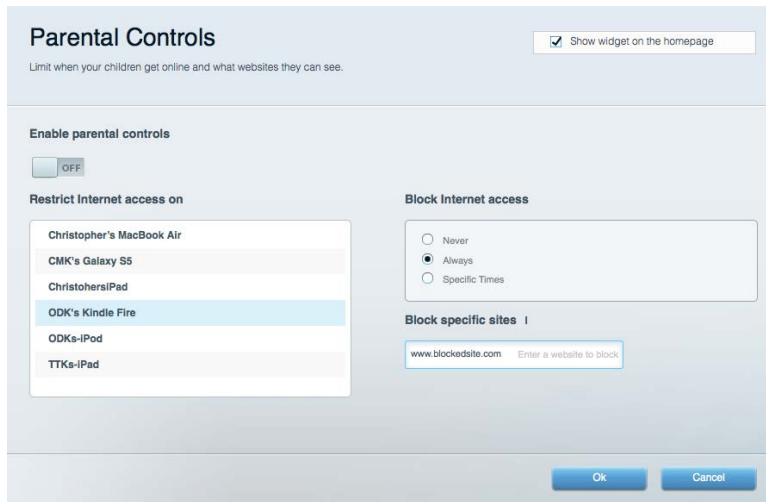

## Prioritering af båndbredde

Her kan du indstille, hvilke enheder og applikationer der skal have størst prioritet i netværkstrafikken.

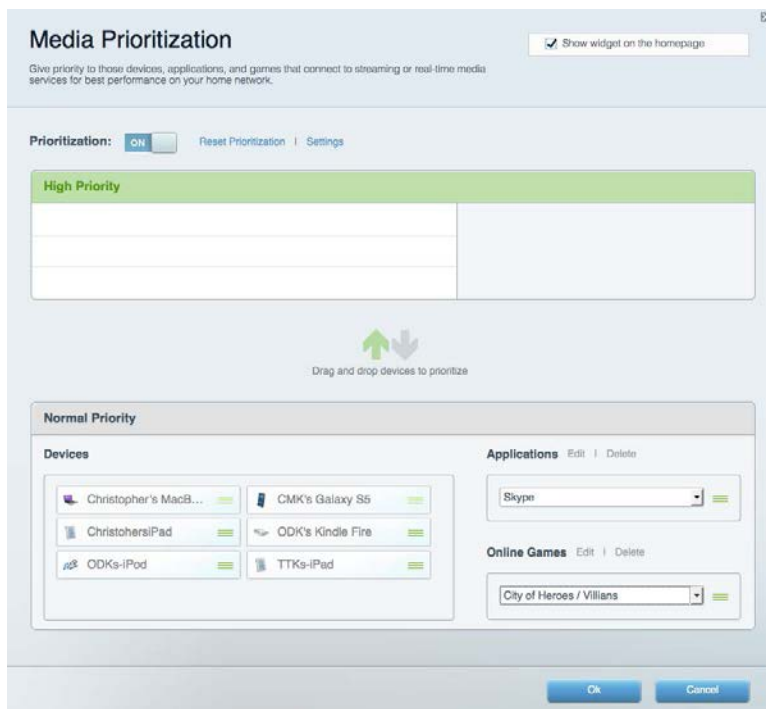

## Test af hastighed

Her kan du teste dit netværks internethastighed.



## Ekstern lagring

Her kan du gå ind på et tilsluttet USB-drev (medfølger ikke) og indstille fildeling, en medieserver og ftp-adgang.

The screenshot shows the 'External Storage' configuration interface. At the top, it says 'External Storage' and 'Connect an external storage device to your network and configure how users can access its contents.' There is a checkbox 'Show widget on the homepage' which is checked. Below this are four tabs: 'Status', 'Folder Access', 'FTP Server', and 'Media Server'. The 'Status' tab is selected. Under 'External Storage Drive', there is a box showing 'External storage volume name: ROUND DRIVE' and a progress bar indicating 'Space used: 886 MB used of 960 MB total.' There are 'Safely remove drive' and 'Refresh' buttons. To the right, there are three sections: 'Secure Folder Access is OFF' with a note 'Any user can access content via shared folders.' and a box containing 'PC access (File explorer): \\192.168.1.1' and 'Mac access (Finder): smb://192.168.1.1'; 'FTP Server is OFF' with a note 'Content is not accessible to any user via FTP.' and a box containing 'FTP server: Disabled'; and 'Media Server (DLNA) is ON' with a note 'Media content is accessible to DLNA clients.' and a box containing 'DLNA server: EA6050'. At the bottom right, there is an 'Ok' button.

# Tilslutning

Her kan du se og ændre grundlæggende og avancerede netværksindstillinger.

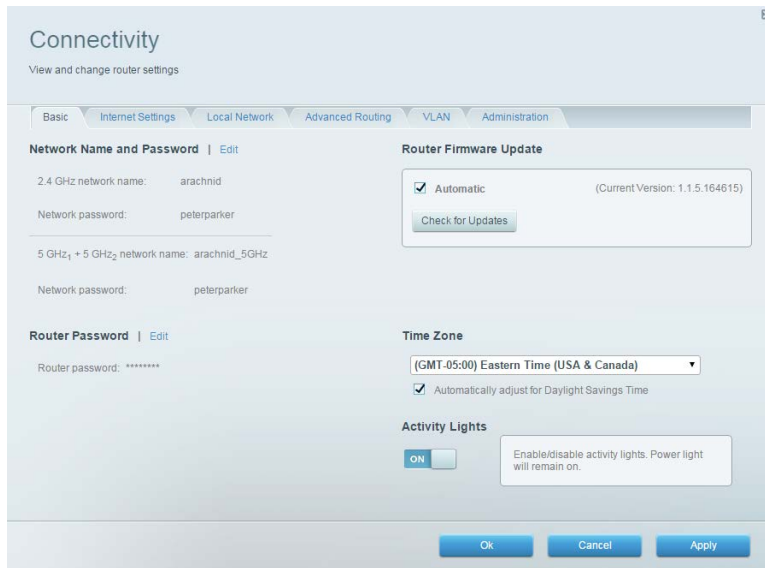

# Fejlfinding

Her kan du fejlsøge problemer på routeren og kontrollere netværkets status.

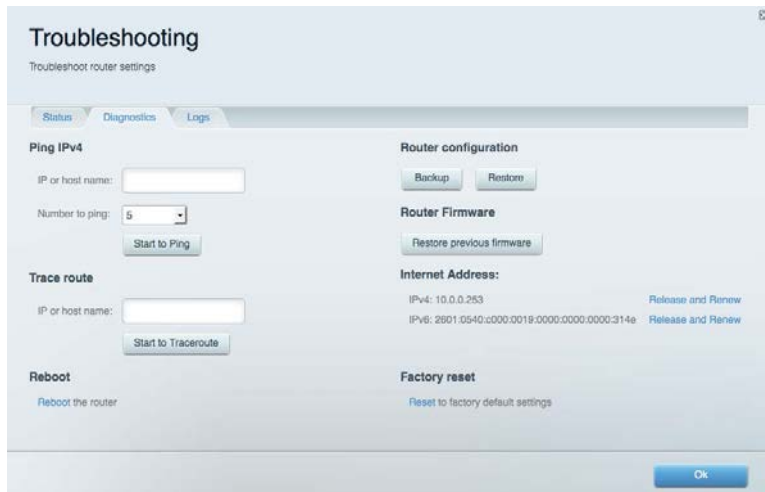

## Trådløs

Her kan du se og ændre routerens trådløse netværk. Du kan ændre netværksnavne, sikkerhedstilstand, adgangskode, MAC-filtrering og tilslutte enheder med Wi-Fi Protected Setup.

The screenshot shows the 'Wireless' settings page. At the top, there is a checkbox for 'Show widget on the homepage' which is checked. Below this, there are tabs for 'Wireless', 'MAC Filtering', and 'Wi-Fi Protected Setup'. The 'Smart Connect' section has two radio buttons: '5 GHz band steering' (selected) and 'Off'. Below this, there are two network configuration sections. The first section is for a 2.4 GHz network with the name 'arachnid', password 'peterparker', and security mode 'WPA2/WPA Mixed Pt'. The second section is for a 5 GHz network with the name 'arachnid\_5GHz', password 'peterparker', and security mode 'WPA2/WPA Mixed Pt'. At the bottom, there are 'Ok', 'Cancel', and 'Apply' buttons.

## Sikkerhed

Her kan du se og ændre routerens trådløse sikkerhed. Du kan konfigurere en firewall og VPN-indstillinger og brugerdefinere indstillinger til programmer og spil.

The screenshot shows the 'Security' settings page. At the top, there are tabs for 'Firewall', 'DMZ', and 'Apps and Gaming'. The 'Firewall' section is active and contains several sub-sections: 'Firewall' with checkboxes for 'IPv4 SPI firewall protection' and 'IPv6 SPI firewall protection', both checked; 'VPN Passthrough' with checkboxes for 'IPSec Passthrough', 'PPTP Passthrough', and 'L2TP Passthrough', all checked; and 'Internet filters' with checkboxes for 'Filter anonymous Internet requests', 'Filter multicast', 'Filter Internet NAT redirection', and 'Filter ident (Port 113)'. At the bottom, there is a table for 'IPv6 Port Services' with columns for 'Description', 'Protocol', 'IPv6 Address', 'Allow', and 'Enabled'. Below the table is an 'Add IPv6 Firewall Setting' button. At the bottom of the page, there are 'Ok', 'Cancel', and 'Apply' buttons.

# Fejlfinding

Du kan få yderligere hjælp af vores prisbelønnede kundesupport på [Linksys.com/support/EA8300](https://Linksys.com/support/EA8300).

## Routeren er ikke installeret rigtigt

Hvis Linksys Smart Wi-Fi ikke fuldfører konfigurationen, kan du prøve følgende:

- Tryk på nulstillingsknappen på din router og hold den inde med en papirclips eller nål, indtil det lysende Linksys logo slukker, og de blå MU-MIMO lamper begynder at blinke (ca. 10 sekunder). Installer routeren igen.

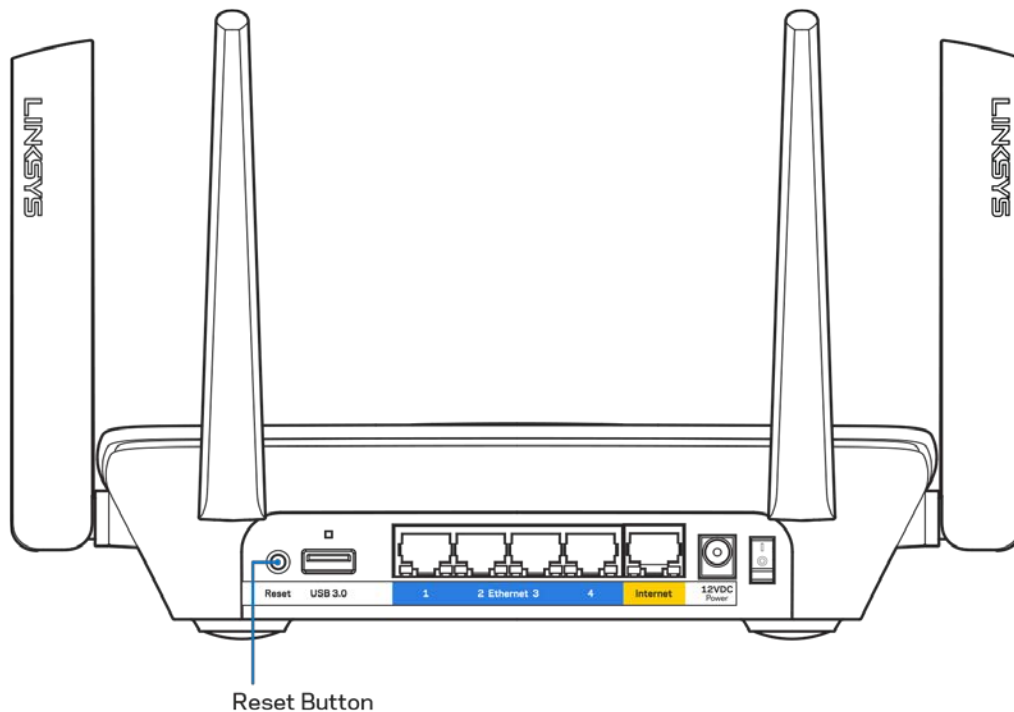

- Slå firewallen på din computer fra midlertidigt (se vejledningen til sikkerhedsprogrammet for hjælp). Installer routeren igen.
- Hvis du har en anden computer, skal du bruge den til at installere routeren igen.

## Meddelelsen *Internetledning ikke tilsluttet*

Benyt følgende fremgangsmåde til fejlfinding, hvis meddelelsen "Internetledning ikke tilsluttet" bliver vist, når du vil installere routeren:

- Sørg for, at der er tilsluttet en Ethernet- eller internetledning (eller en ledning tilsvarende den, der medfølger til routeren) korrekt i den gule internetport bag på routeren og i den rigtige port på modemmet. Denne port på modemmet er normalt mærket Ethernet.

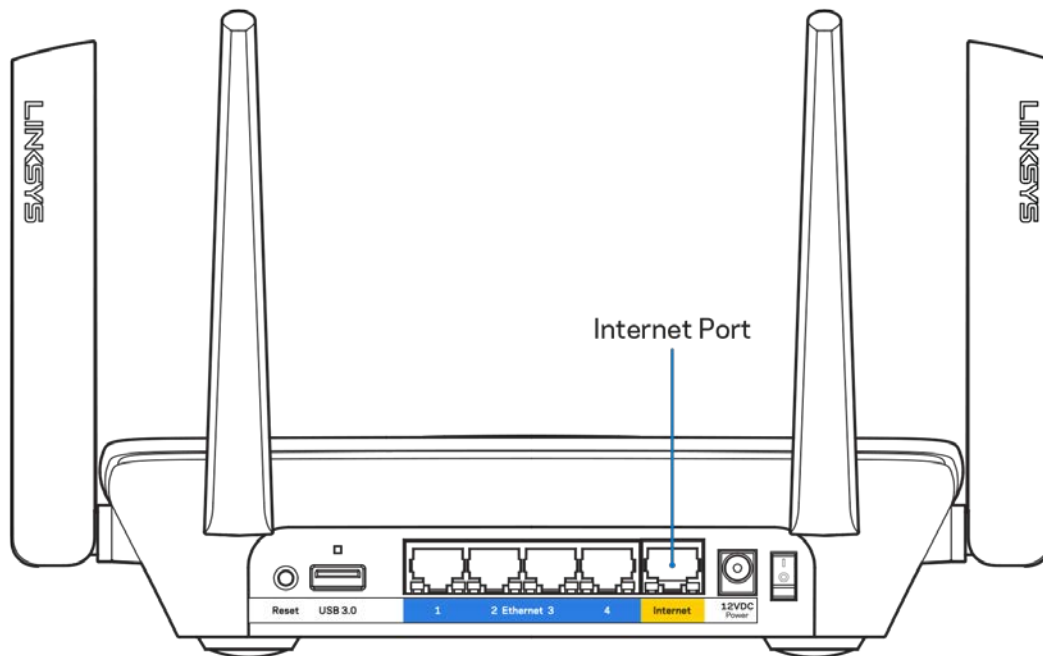

- Sørg for, at modemmet er tilsluttet strømkilden og er tændt. Hvis der er en tænd/sluk-knap, skal den være i stillingen ON eller I (tændt (ikke O)).

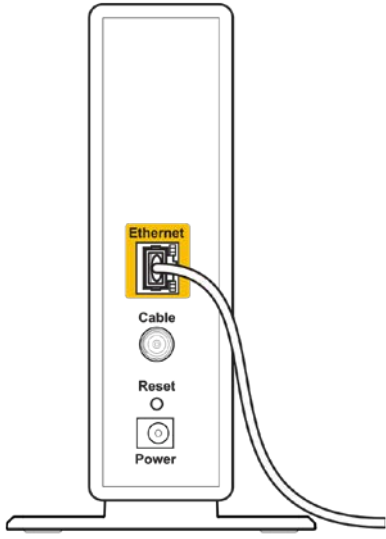
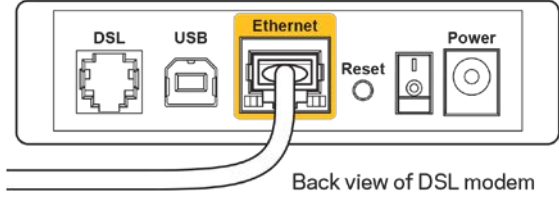

 <p>Back view of cable modem</p>	 <p>Back view of DSL modem</p>
<p>Hvis din internettjeneste er kablet, skal du kontrollere, at det medfølgende koaksialkabel fra din internetudbyder er tilsluttet i kabelmodemets CABLE-port.</p>	<p>Eller, hvis din internettjeneste er en DSL-forbindelse, skal DSL-telefonledningen være tilsluttet i modemets DSL-port.</p>

- Hvis din computer har været tilsluttet modemmet tidligere med en USB-ledning, skal du tage ledningen ud.
- Installer routeren igen.

## Meddelelsen *Ingen adgang til routeren*

For at få adgang til routeren skal du have forbindelse til dit netværk. Hvis der er trådløs internetadgang, kan problemet være, at du ved en fejl har oprettet forbindelse til et andet trådløst netværk.

Benyt følgende fremgangsmåde til at afhjælpe problemet på Windows computere\*:

1. Klik på ikonet for trådløs forbindelse på proceslinjen. Der bliver vist en liste med tilgængelige trådløse netværk.

2. Klik på dit netværks navn. Klik på Opret forbindelse. I eksemplet nedenfor er computeren tilsluttet et andet trådløst netværk, som hedder wraith\_5GHz. Det trådløse netværks navn for Linksys EA8300-routeren (Damaged\_Beez2.4 i dette eksempel) bliver vist markeret.



3. Hvis du bliver bedt om at indtaste en sikkerhedsnøgle til netværket, skal du indtaste din adgangskode (sikkerhedsnøgle) i feltet til sikkerhedsnøglen til netværket. Klik på OK.
4. Din computer opretter forbindelse til netværket, og nu skal der være adgang til routeren.

*\*Alt efter hvilken version af Windows du har, kan ordlyden eller ikonerne variere i vejledningen nedenfor.*

Benyt følgende fremgangsmåde til at afhjælpe problemet på Mac computere:

1. Klik på Wi-Fi ikonet på menulinjen øverst i vinduet. Der bliver vist en liste med trådløse netværk.
2. I eksemplet nedenfor er computeren tilsluttet et andet trådløst netværk, som hedder wraith\_5GHz. Det trådløse netværks navn for Linksys EA8300-routeren (Damaged\_Beez2.4 i dette eksempel) bliver vist markeret.



3. Klik på navnet for det trådløse netværk på Linksys EA8300-routeren (Damaged\_Beez2.4 i dette eksempel).
4. Indtast adgangskoden til det trådløse netværk (sikkerhedsnøgle) i feltet Adgangskode. Klik på OK.

## Efter installationen

### Internettet ser ud til ikke at være tilgængeligt

Hvis der er problemer med internetforbindelsen til routeren, kan meddelelsen "Kan ikke finde [internetadresse]" blive vist i browseren. Hvis du ved, at webadressen er korrekt, og du har prøvet med flere gyldige webadresser og fået det samme resultat, kan meddelelsen betyde, at der er et problem hos din internetudbyder eller med modemkommunikationen med din router. Prøv følgende:

- Kontroller, at netværks- og strømledningen er korrekt tilsluttet.
- Kontroller, at der er strøm til den stikkontakt, som routeren er tilsluttet.
- Genstart routeren.
- Kontakt din internetudbyder og spørg, om der er driftsnedbrud, hvor du bor.

Den mest almindelige metode til fejlfinding af routeren er ved at slukke for den og tænde for den igen. Derefter kan routeren genindlæse de brugerdefinerede indstillinger, og øvrige enheder (f.eks. modemmet) kan registrere routeren igen og kommunikere med den. Det kaldes at genstarte routeren.

Benyt følgende fremgangsmåde til at genstarte routeren med strømledningen:

1. Frakobl strømledningen fra routeren og modemmet.
2. Vent 10 sekunder, og tilslut strømledningen til modemmet igen. Kontroller, at der er tilsluttet strøm.
3. Vent, indtil modemets online lampe ophører med at blinke (ca. 2 minutter). Tilslut strømledningen til routeren igen.
4. Vent, indtil det lysende Linksys logo tændes. Vent 2 minutter med at forsøge at oprette forbindelse til internettet fra en computer.

Benyt følgende fremgangsmåde til at genstarte routeren ved hjælp af Linksys Smart Wi-Fi:

1. Log på Linksys Smart Wi-Fi (se "Oprettelse af forbindelse til Linksys Smart Wi-Fi" på side [11](#)).
2. Klik på *Fejlfinding* under *Routerindstillinger*.
3. Klik på fanen *Diagnosticering*.

4. Klik på *Genstart under* Genstart.



5. Klik på **Ja**. Routeren genstartes. Mens routeren genstarter, mister alle tilsluttede enheder internetforbindelsen. De opretter forbindelse igen automatisk, når routeren er genstartet.

## Linksys Smart Wi-Fi åbner ikke i browseren

De nyeste versioner af Google Chrome™, Firefox®, Safari® (til Mac® og iPad®), Microsoft Edge og Internet Explorer® version 8 og nyere fungerer med Linksys Smart Wi-Fi.

# Specifikationer

## Linksys EA8300

Modelnavn	Max-Stream AC2200 MU-MIMO Tri-Band Router
Modelnummer	EA8300
Switch-porthastighed	10/100/1000 Mbps (Gigabit Ethernet)
Radiofrekvens	2,4 GHz og 5 GHz (2 stk.)
Antal antenner	4 udvendige, justerbare antenner (ikke aftagelige)
Porte	USB 3.0, Ethernet (1-4), internet, strøm
Knapper	Wi-Fi Protected Setup, strøm, nulstilling
Lamper	<b>Øverst:</b> Lysende Linksys logo, Wi-Fi Protected Setup, internetforbindelse, tilslutning af netværksledning i internetport <b>Bag på:</b> USB, Ethernet (1-4), internet
UPnP	Understøttet
Sikkerhedsfunktioner	WEP, WPA2, RADIUS
Sikkerhedsnøglebit	Op til 128-bit kryptering
Understøttede filsystemer	FAT, NTFS og HFS+
Understøttede browsere	De nyeste versioner af Google Chrome™, Firefox®, Safari® (til Mac® og iPad®), Microsoft Edge og Internet Explorer® version 8 og nyere

## Omgivelser

Mål	213,7 mm x 161,8 mm x 54,8 mm (uden antenner)
Enhedens vægt	608 g
Strøm	12 V, 2 A
Certificeringer	FCC, IC, CE, Wi-Fi (a/b/g/n/ac)
Driftstemperatur	0-40° C
Opbevaringstemperatur	-20 til 60° C
Luftfugtighed ved brug	10-80% relativ luftfugtighed, ikke-kondenserende
Luftfugtighed ved opbevaring	5-90% ikke-kondenserende

Specifikationerne er med forbehold for ændringer uden varsel.

Bemærk:

Se den medfølgende cd til routeren, eller se [Linksys.com/support/EA8300](http://Linksys.com/support/EA8300) for lovkrav, garantier og sikkerhedsoplysninger.

Maksimal ydeevne ifølge specifikationerne for IEEE-standard 802.11. Den faktiske ydeevne kan variere, f.eks. kan der være lavere netværkskapacitet, dataoverførselshastighed, rækkevidde og dækning. Ydeevnen afhænger af mange faktorer, betingelser og variable, bl.a. afstanden fra adgangspunktet, netværkstrafikmængden, bygningens materialer og konstruktion, det anvendte operativsystem, kombinationen af de trådløse produkter, der anvendes, interferens og andre ugunstige forhold.

BELKIN, LINKSYS og mange af produktnavnene og logoerne er varemærker tilhørende Belkin koncernen. Tredjeparters varemærker, som er nævnt heri, tilhører de respektive ejere. Licenser og meddelelser vedrørende tredjepartssoftware, som anvendes i dette produkt, kan ses her: <http://support.linksys.com/en-us/license>. Se <http://support.linksys.com/en-us/gplcodecenter>, hvis du har spørgsmål eller ønsker GPL-kildekode.

© 2017 Belkin International, Inc. og/eller selskabets associerede virksomheder. Alle rettigheder forbeholdes.

**LINKSYS®**

Benutzerhandbuch

**MAX-STREAM™  
AC2200 MU-MIMO  
TRI-BAND-ROUTER**

Modell EA8300

# Inhalt

<b>Produktübersicht</b> .....	<b>3</b>
Ansicht von oben .....	3
Systemstatusanzeige.....	4
Rückseite.....	5
Seitenansicht.....	6
<b>Einrichtung: Grundlagen</b> .....	<b>7</b>
Hier finden Sie weitere Unterstützung.....	7
Ihren Router installieren.....	8
<b>So verwenden Sie Linksys Smart Wi-Fi</b> .....	<b>11</b>
Eine Verbindung zu Linksys Smart Wi-Fi herstellen .....	11
Netzwerkübersicht .....	12
Gastzugriff.....	12
Kinderschutzfunktionen.....	13
Medienpriorisierung.....	13
Geschwindigkeitstest.....	14
Externer Speicher .....	14
Konnektivität.....	15
Fehlerbehebung .....	15
Wireless (WLAN).....	16
Sicherheit.....	16
<b>Fehlerbehebung</b> .....	<b>17</b>
Ihr Router wurde nicht erfolgreich eingerichtet.....	17
<i>Meldung</i> „Ihr Internetkabel ist nicht angeschlossen“.....	18
<i>Meldung</i> „Kein Zugriff auf den Router“ .....	19
Nach dem Setup.....	21
Kein Zugriff auf das Internet.....	21
Linksys Smart Wi-Fi lässt sich nicht im Webbrowser öffnen.....	22
<b>Technische Daten</b> .....	<b>23</b>
Linksys EA8300 .....	23
Betriebsbedingungen.....	23



# Produktübersicht

## Ansicht von oben

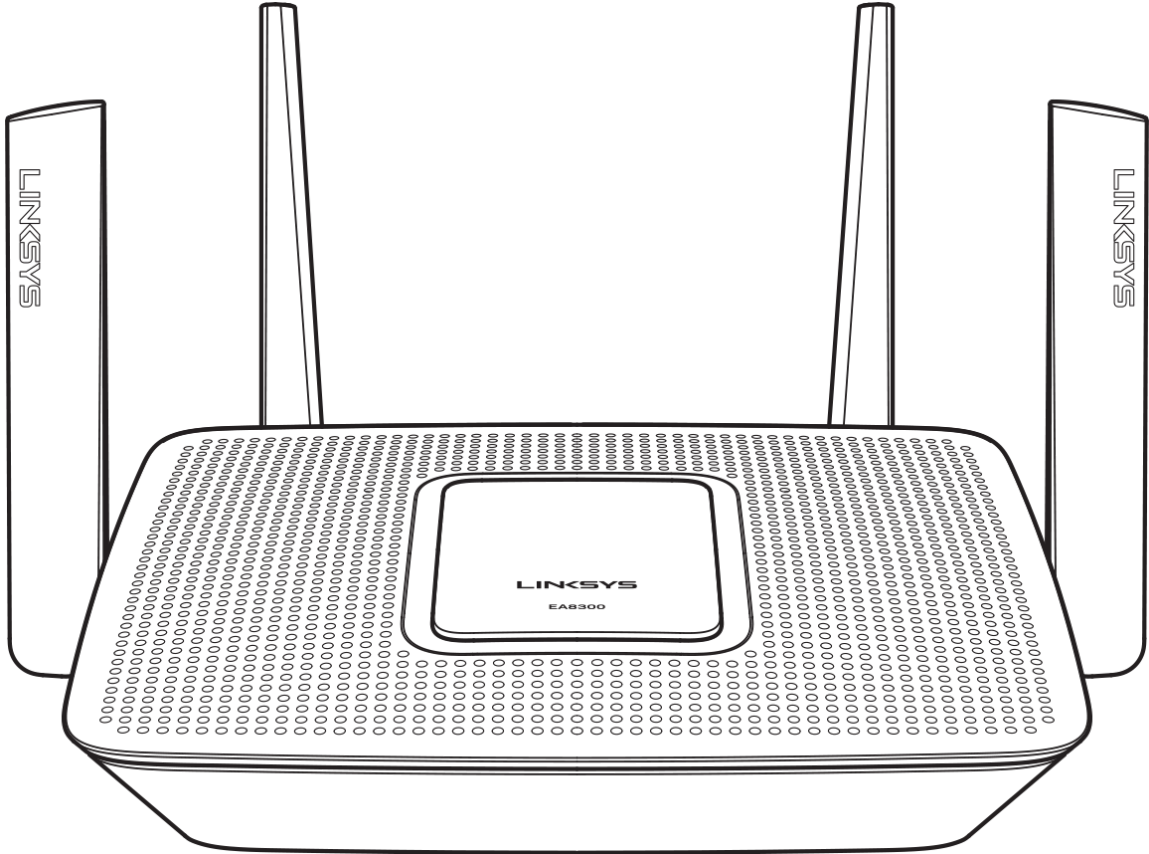

## Systemstatusanzeige

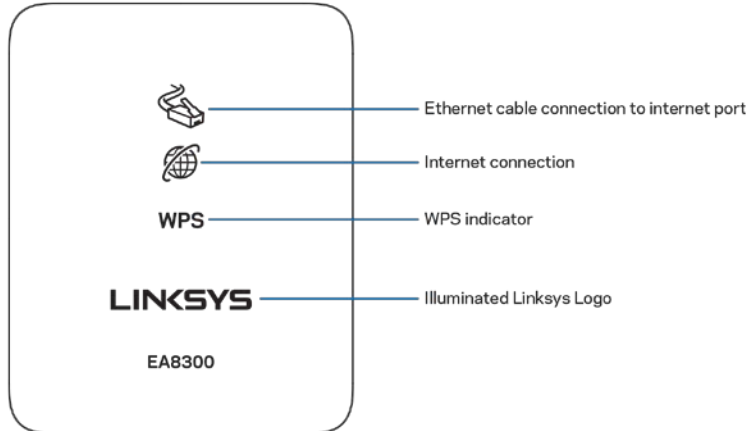

**Ethernetkabelverbindung am Internetanschluss** - Oranges Leuchten zeigt ein Problem mit dem Netzkabel an, das an den Internetanschluss (WAN) angeschlossen ist.

**Internetverbindung** - Oranges Leuchten zeigt an, dass der Router keine Verbindung mit dem Internet herstellen kann.

**WPS-Anzeige (Wi-Fi Protected Setup™)** - die WPS-Leuchte kann vier Zustände anzeigen:

<b>Aus</b>	Wi-Fi Protected Setup ist nicht in Betrieb
<b>Weißer Blinkanzeige</b>	Wi-Fi Protected Setup ist in Betrieb
<b>Weißes Dauerlicht</b>	Wi-Fi Protected Setup ist erfolgreich abgeschlossen; Leuchte bleibt fünf Sekunden an
<b>Oranges Blinklicht</b>	Fehler beim Wi-Fi Protected Setup; Leuchte blinkt eine Minute lang und geht danach aus

**Erleuchtetes Linksys-Logo** - Blinkt während des Startens des Routers. Wenn das Logo weißes Dauerlicht anzeigt, ist der Router eingeschaltet und funktioniert korrekt.

## Rückseite

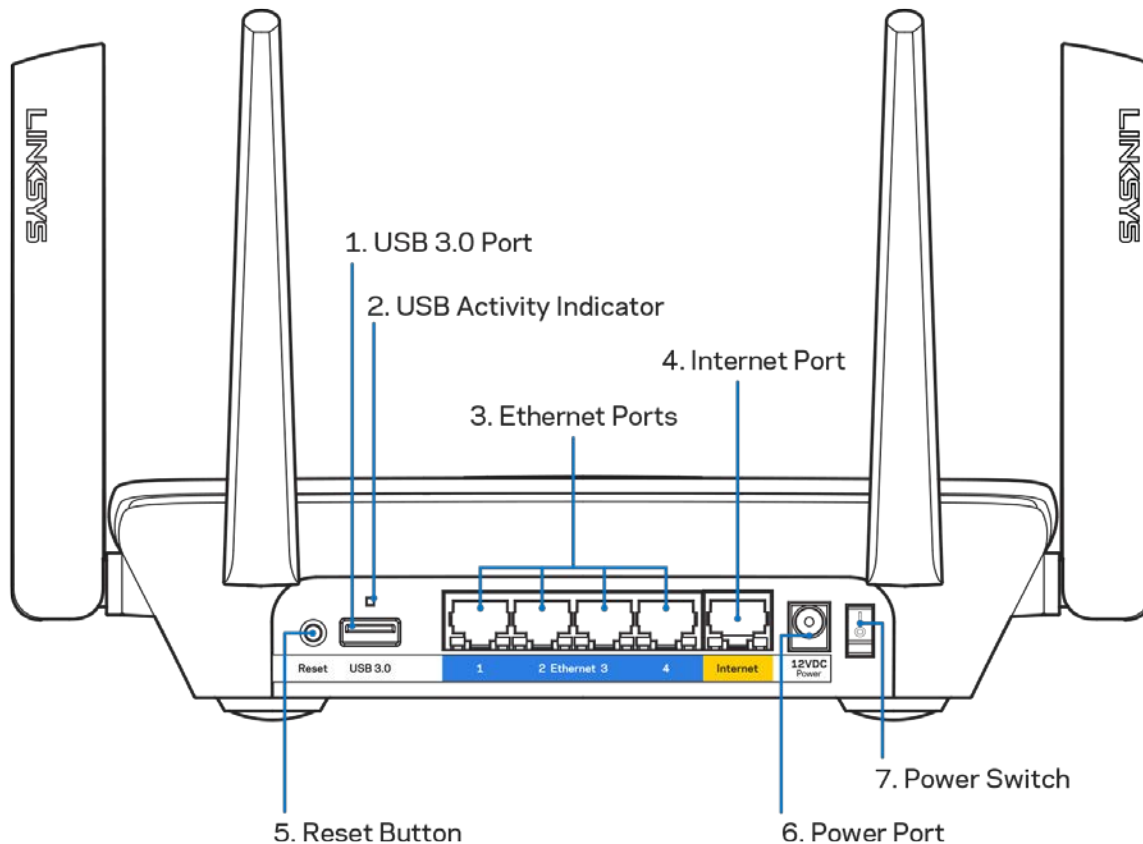

**USB-3.0-Port (1)** - Schließen Sie USB-Laufwerke zur gemeinsamen Nutzung in Ihrem Netzwerk oder im Internet an.

**USB-Aktivitätsleuchte (2)** - Leuchten zeigen Datenübertragung zu und von externen Geräten an.

**Ethernet-Ports (3)** - Mithilfe von Ethernet-Kabeln können über diese blau markierten Gigabit-Ports (10/100/1000) kabelgebundene Geräte mit Ihrem Netzwerk verbunden werden.

*Hinweis: Die beste Leistung erzielen Sie, wenn Sie CAT5e-Kabel oder Kabel einer höheren Kategorie an die Ethernet-Ports anschließen.*

**Internet-Port (4)** - Schließen Sie ein Ethernet-Kabel an diesen gelben Gigabit-Port (10/100/1000) und an ein Breitband-Internet-, Kabel-, DSL- oder Glasfaser-Modem an.

*Hinweis: Die beste Leistung erzielen Sie, wenn Sie CAT5e-Kabel oder Kabel einer höheren Kategorie an den Internet-Port anschließen.*

**Reset-Taste (5)** - Halten Sie die Taste gedrückt, bis das Linksys-Logo ausgeht, um den Router auf die Werkseinstellungen zurückzusetzen. Sie können die Werkseinstellungen auch durch Verwendung von Linksys Smart Wi-Fi im Internet oder auf der mobilen App wiederherstellen.

**Stromanschluss (6)** - Schließen Sie hier das im Lieferumfang enthaltene Netzteil an.

**Ein/Aus-Schalter (7)** - Drücken Sie | (ein), um den Router einzuschalten.

## Seitenansicht

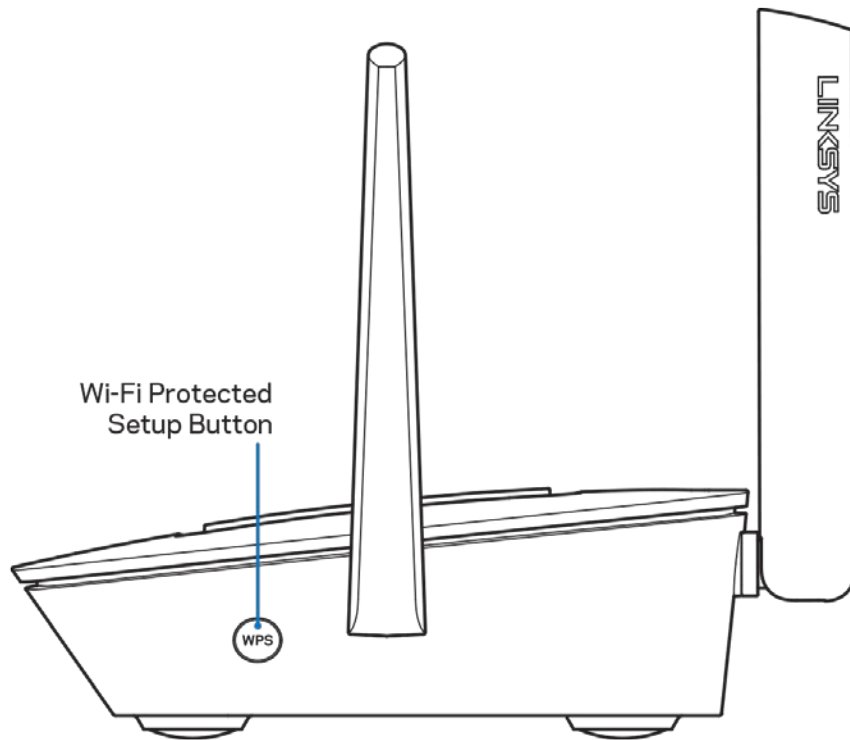

**Wi-Fi Protected Setup™-Taste** - Drücken Sie diese Taste, um WPS-fähige Netzwerkgeräte zu verbinden.

# Einrichtung: Grundlagen

## Hier finden Sie weitere Unterstützung

Neben diesem Benutzerhandbuch erhalten Sie Hilfe unter:

- [Linksys.com/support/EA8300](http://Linksys.com/support/EA8300) (Dokumentation, Downloads, FAQs [häufig gestellte Fragen], technischer Support, Live-Chat, Foren)
- Linksys Smart Wi-Fi-Hilfe (stellen Sie eine Verbindung zu Linksys Smart Wi-Fi her, und klicken Sie dann oben im Bildschirm auf Help [Hilfe])

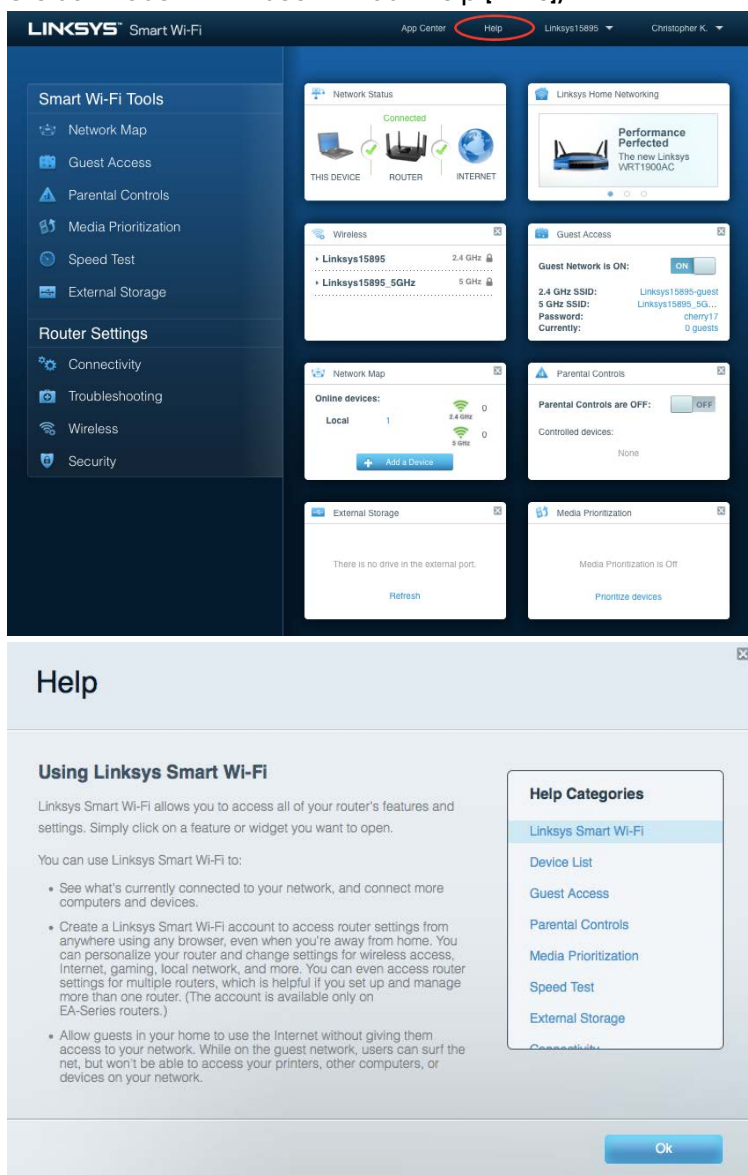

**Hinweis:** Lizenzen und Hinweise zur Software Dritter, die auf diesem Produkt zum Einsatz kommt, finden Sie hier: <http://support.linksys.com/en-us/license>. Antworten auf Fragen und Informationen zum GPL-Quellcode finden Sie unter: <http://support.linksys.com/en-us/gplcodecenter>

## Ihren Router installieren

1. Um das Setup auszuführen, müssen Sie auf einem Computer in einem Webbrowser folgende URL aufrufen: <http://LinksysSmartWiFi.com>.
2. Welche Geräte haben Sie?

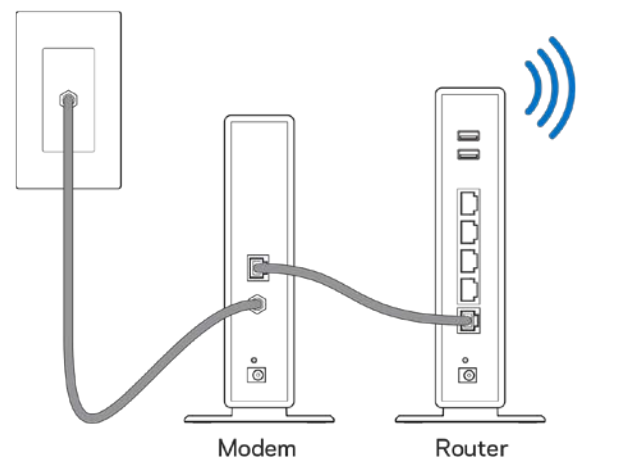
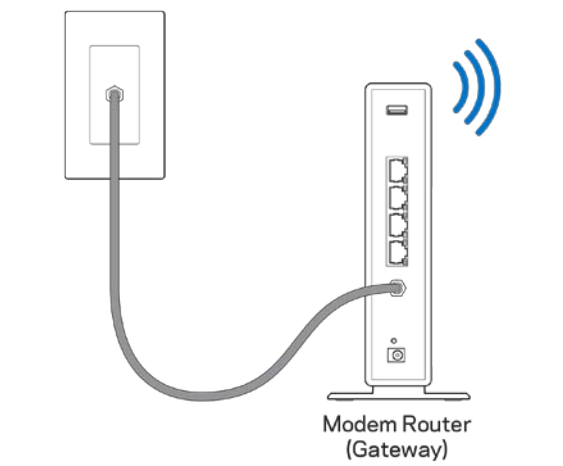
 <p>Das Diagramm zeigt zwei separate Geräte: ein Modem und einen Router. Ein Kabel verbindet das Modem mit dem Router. Die Geräte sind an eine Steckdose angeschlossen. Ein WLAN-Symbol ist rechts neben dem Router zu sehen.</p>	 <p>Das Diagramm zeigt ein einziges Gerät, ein Modem-Router (Gateway), das an eine Steckdose angeschlossen ist. Ein WLAN-Symbol ist rechts neben dem Gerät zu sehen.</p>
<p>Wenn Sie ein separates Modem und einen eigenständigen Router haben, trennen Sie die Verbindung Ihres alten Routers und entfernen Sie ihn.</p>	<p>Wenn Sie einen Modem-Router haben, lassen Sie ihn angeschlossen.</p>

3. Richten Sie die Antennen nach oben aus und schließen Sie den Router an eine Steckdose an. Vergewissern Sie sich, dass der Ein-/Ausschalter auf | „On“ (Ein) steht.
4. Schließen Sie Ihren Router an Ihr Modem oder Ihren Modem-Router an. Schließen Sie ein Ende des enthaltenen Internetkabels an den gelben Internetanschluss am Router an. Wenn Sie ein Modem haben, schließen Sie das andere Ende an den Ethernetanschluss (LAN) am Modem an. Wenn Sie einen Modem-Router haben, schließen Sie das Kabel an einen freien Anschluss an.
5. Warten Sie, bis die Linksys-Leuchte an der Oberseite Ihres Routers aufhört zu blinken und weißes Dauerlicht anzeigt.
6. Stellen Sie eine Verbindung mit dem WLAN-Netzwerk her, das in der im Lieferumfang Ihres Routers enthaltenen Kurzanleitung angegeben wird. (Sie können diese Daten später ändern.) Weitere Informationen zur Herstellung einer Verbindung mit dem Netzwerk finden Sie in der Dokumentation Ihres Geräts auf [linksys.com/support/ea8300](http://linksys.com/support/ea8300).

**Hinweis:** Sie haben keinen Internetzugriff, bis die Routereinrichtung abgeschlossen ist.

7. Geben Sie <http://LinksysSmartWiFi.com> in einen Web-Browser ein. Folgen Sie den Anweisungen auf Ihrem Bildschirm, um die Einrichtung auszuführen. Sie können auch [192.168.1.1](http://192.168.1.1) in den Browser eingeben, um das Setup zu starten.

Folgen Sie nach der Einrichtung den Anweisungen auf dem Bildschirm, um Ihr Linksys Smart Wi-Fi-Konto einzurichten. Mit Linksys Smart Wi-Fi können Sie Ihren Router von einem beliebigen Computer mit Internetverbindung aus konfigurieren.

Sie können folgende Routereinstellungen vornehmen/ändern:

- Ändern des Routernamens und -kennworts
- Einrichten des Gastzugriffs
- Konfigurieren der Kinderschutzfunktionen
- Verbinden von Geräten mit Ihrem WLAN
- Internetgeschwindigkeit testen

**Hinweis:** Zum Einrichten Ihres Linksys Smart Wi-Fi-Kontos erhalten Sie eine Bestätigungs-E-Mail. Klicken Sie auf den Link in der E-Mail (über Ihr Heimnetzwerk), um den Router Ihrem Linksys Smart Wi-Fi-Konto zuzuordnen.

**Tipp:** Drucken Sie diese Seite aus, und geben Sie die Router- und Kontoeinstellungen zum späteren Nachschlagen in die Tabelle ein. Bewahren Sie die Seite an einem sicheren Ort auf.

2,4-GHz-WLAN-Name	
WLAN-Kennwort	
5-GHz <sub>1</sub> -WLAN-Name	
WLAN-Kennwort	
5-GHz <sub>2</sub> -WLAN-Name	
WLAN-Kennwort	
Routerkennwort	
2,4-GHz-Gast-WLAN-Name	
5-GHz-Gast-WLAN-Name	
Gast-WLAN-Kennwort (beide Gastnetzwerke haben dasselbe Kennwort.)	
Linksys Smart Wi-Fi-Benutzername	
Linksys Smart Wi-Fi-Kennwort	



# So verwenden Sie Linksys Smart Wi-Fi

Die Verwaltung Ihres Routers ist mit Linksys Smart Wi-Fi von überall auf Welt aus möglich. Sie kann aber auch direkt über Ihr Heimnetzwerk erfolgen. Linksys Smart Wi-Fi ist möglicherweise auch für Ihr mobiles Gerät verfügbar. Entsprechende Informationen finden Sie im App-Store Ihres Geräts.

## Eine Verbindung zu Linksys Smart Wi-Fi herstellen

So stellen Sie eine Verbindung zu Linksys Smart Wi-Fi her:

1. Öffnen Sie den Webbrowser Ihres Computers.
2. Rufen Sie <http://LinksysSmartWiFi.com> auf und melden Sie sich bei Ihrem Konto an.

Linksys Smart Wi-Fi Sign In

If you have not yet created a Linksys Smart Wi-Fi account, click the "Create Account" button in the upper right corner of the page.

Give guests Internet access

Use your Linksys Smart Wi-Fi account to access your home network from anywhere, at any time, even from your mobile device. Easily connect new devices, set parental controls, get access to Smart Wi-Fi mobile Apps, and more.

For more information [click here](#)

English (United States)

For local access, [click here](#).

Wenn Sie Ihr Kennwort vergessen haben, klicken Sie auf *Forgot your password?* (Kennwort vergessen?) und folgen Sie den Anweisungen auf dem Bildschirm, um es wiederherzustellen.

## Netzwerkübersicht

Ermöglicht das Anzeigen und Verwalten aller Netzwerkgeräte, die mit dem Router verbunden sind. Sie können die verbundenen Geräte Ihres Haupt- und Gastnetzwerks anzeigen lassen oder Informationen zu jedem Gerät abrufen.



## Gastzugriff

Gibt Ihnen die Möglichkeit zur Einrichtung und Kontrolle eines Netzwerks, das Gästen den Zugriff auf das WLAN, jedoch nicht auf Ihre persönlichen Daten ermöglicht.

The screenshot shows the 'Guest Access' configuration page. At the top, there is a checkbox 'Show widget on the homepage' which is checked. Below this, there is a description: 'Guest access allows visitors to connect to your wireless guest network and access the Internet, without giving access to your other computers or personal data.' The main configuration area includes: 'Allow guest access' with a toggle switch set to 'ON'; 'Guest network names and password' section with '2.4 GHz SSID: parlor2.4', 'Network: Enabled', '5 GHz SSID: parlor5', 'Network: Enabled', and 'Guest network password: thefly'; and 'Total guests allowed' set to '5 guests'. A warning box with an exclamation mark icon contains the text: 'Your guest should first connect to your guest network, open a web browser, and then enter the guest password.' At the bottom, there are 'OK' and 'Cancel' buttons.

# Kinderschutzfunktionen

Ermöglicht das Sperren von Websites und Festlegen von Internetzugriffszeiten.

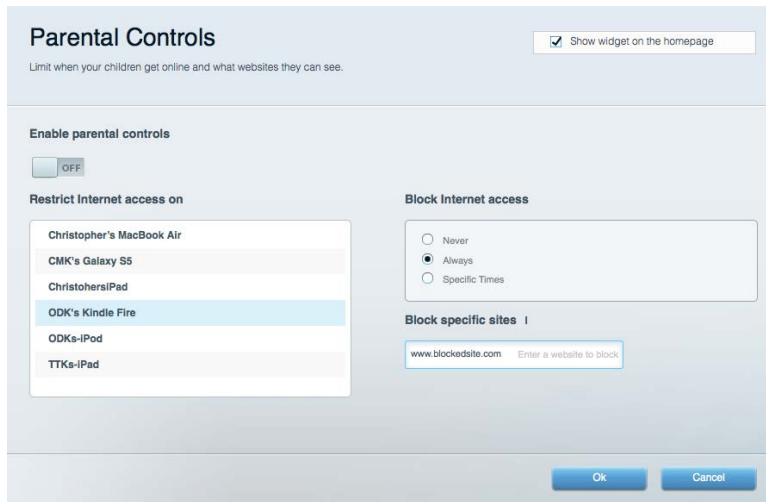

# Medienpriorisierung

Ermöglicht es festzulegen, welche Geräte und Anwendungen in Bezug auf den Netzwerkdatenverkehr oberste Priorität haben.

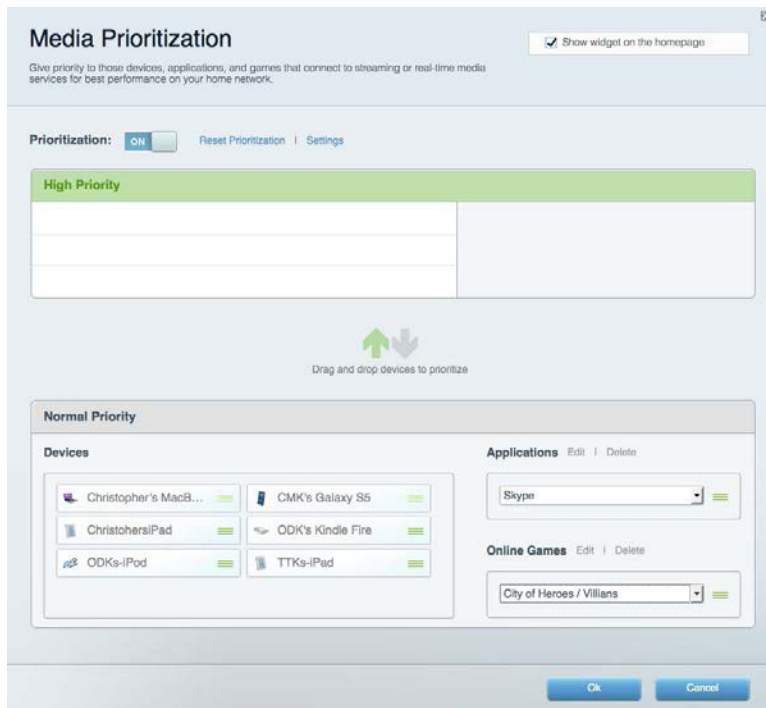

## Geschwindigkeitstest

Ermöglicht das Überprüfen der Internetgeschwindigkeit.



## Externer Speicher

Ermöglicht den Zugriff auf ein angeschlossenes USB-Laufwerk (nicht im Lieferumfang enthalten) sowie das Einrichten von Filesharing, einem Medienserver und einem FTP-Zugang.



## Konnektivität

Ermöglicht Ihnen die Ansicht und das Verändern grundlegender und erweiterter Netzwerkeinstellungen.

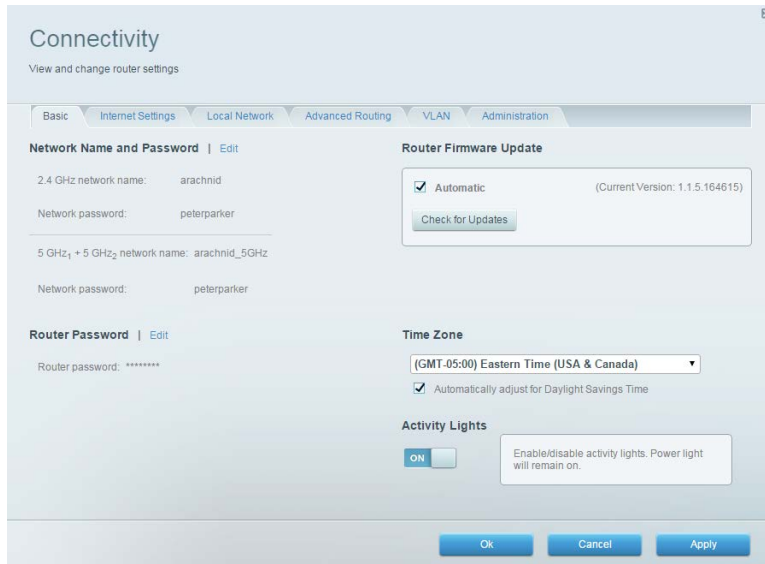

## Fehlerbehebung

Ermöglicht das Identifizieren von Routerproblemen und das Überprüfen des Netzwerkstatus.

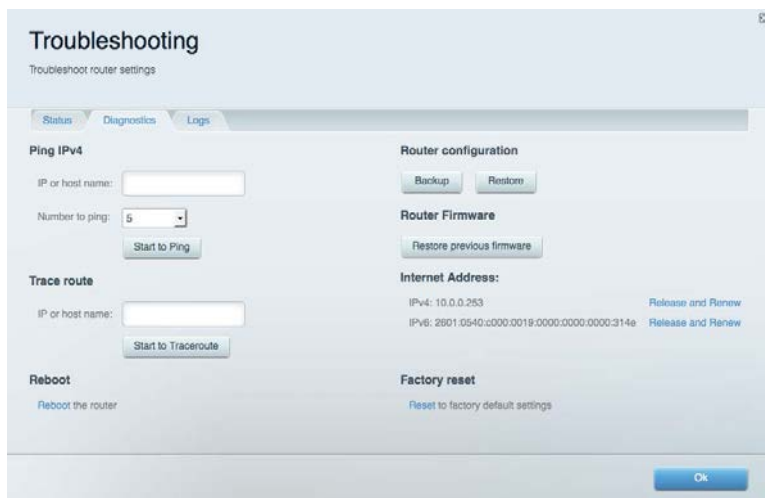

## Wireless (WLAN)

Ermöglicht Ihnen die Ansicht und das Verändern des WLAN-Netzwerks Ihres Routers. Netzwerknamen, Sicherheitsmodus, Kennwort und Einstellungen der MAC-Filterung können geändert und Geräte über das Wi-Fi Protected Setup verbunden werden.

The screenshot shows the 'Wireless' settings page. At the top, there is a 'Show widget on the homepage' checkbox which is checked. Below this, there are tabs for 'Wireless', 'MAC Filtering', and 'Wi-Fi Protected Setup'. The 'Smart Connect' section has two radio buttons: '5 GHz band steering' (selected) and 'Off'. Below this, there are two network configuration sections. The first is for the 2.4 GHz band with network name 'arachnid', password 'peterparker', and security mode 'WPA2/WPA Mixed Pt'. The second is for the 5 GHz band with network name 'arachnid\_5GHz', password 'peterparker', and security mode 'WPA2/WPA Mixed Pt'. At the bottom, there are 'Ok', 'Cancel', and 'Apply' buttons.

## Sicherheit

Ermöglicht Ihnen die Ansicht und das Verändern der WLAN-Sicherheit Ihres Routers. Firewall- und VPN-Einstellungen können bearbeitet und benutzerdefinierte Einstellungen für Anwendungen und Spiele festgelegt werden.

The screenshot shows the 'Security' settings page. It has tabs for 'Firewall', 'DMZ', and 'Apps and Gaming'. The 'Firewall' section is active and shows 'IPv4 SPI firewall protection' and 'IPv6 SPI firewall protection' both checked and enabled. The 'VPN Passthrough' section shows 'IPSec Passthrough', 'PPTP Passthrough', and 'L2TP Passthrough' all checked and enabled. The 'Internet filters' section has 'Filter anonymous Internet requests' checked, while 'Filter multicast', 'Filter Internet NAT redirection', and 'Filter ident (Port 113)' are unchecked. At the bottom, there is a table for 'IPv6 Port Services' with columns for Description, Protocol, IPv6 Address, Allow, and Enabled. Below the table is an 'Add IPv6 Firewall Setting' button. At the very bottom, there are 'Ok', 'Cancel', and 'Apply' buttons.

# Fehlerbehebung

Weitere Unterstützung erhalten Sie von unserem preisgekrönten Kundendienst unter [linksys.com/support/EA8300](http://linksys.com/support/EA8300).

## Ihr Router wurde nicht erfolgreich eingerichtet.

Wenn Linksys Smart Wi-Fi das Setup nicht abgeschlossen hat, können Sie folgendermaßen vorgehen:

- Halten Sie die Reset-Taste auf Ihrem Router mit einer Büroklammer oder einem Metallstift gedrückt, bis die Leuchte des Linksys-Logos ausgeht und die blauen MU-MIMO-Anzeigen anfangen zu blinken (ca. 10 Sekunden). Installieren Sie den Router erneut.

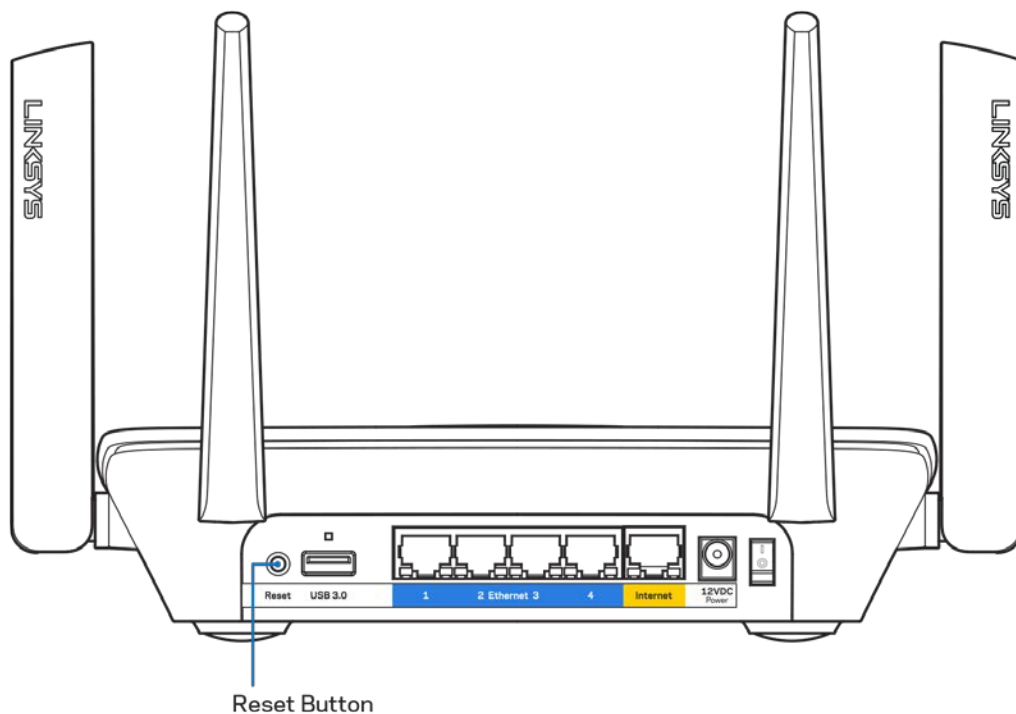

- Deaktivieren Sie vorübergehend die Firewall Ihres Computers (weitere Informationen hierzu finden Sie in den Anweisungen der Sicherheitssoftware). Installieren Sie den Router erneut.
- Wenn Ihnen ein anderer Computer zur Verfügung steht, versuchen Sie den Router über diesen zu installieren.

## Meldung „Ihr Internetkabel ist nicht angeschlossen“

Wenn bei der Routereinrichtung die Meldung „Ihr Internetkabel ist nicht angeschlossen“ angezeigt wird, gehen Sie nach folgenden Schritten vor.

- Stellen Sie sicher, dass ein Ethernet- oder Internetkabel (oder ein Kabel, das dem mitgelieferten Kabel Ihres Routers gleicht) fest an den gelben Internet-Port auf der Rückseite des Routers und an den entsprechenden Port des Modems angeschlossen ist. Dieser Port auf dem Modem ist normalerweise mit der Bezeichnung „Ethernet“ versehen.

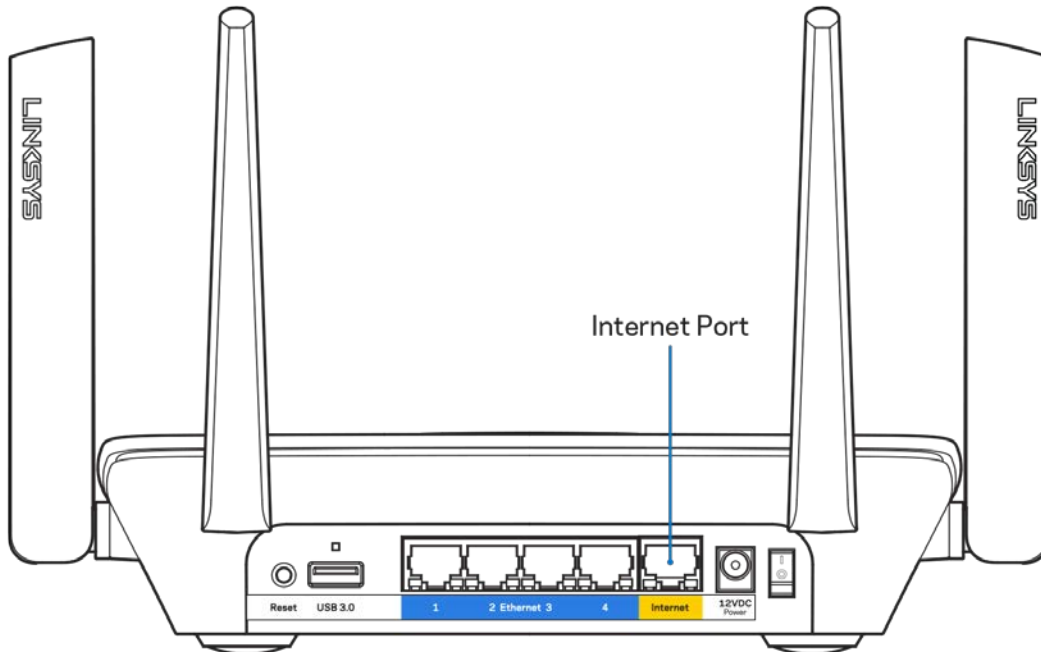

- Vergewissern Sie sich, dass das Modem an einer Steckdose eingesteckt und eingeschaltet ist. Wenn es über einen Ein/Aus-Schalter verfügt, stellen Sie sicher, dass dieser auf die Position ON (Ein) oder | gestellt ist (und nicht auf O).

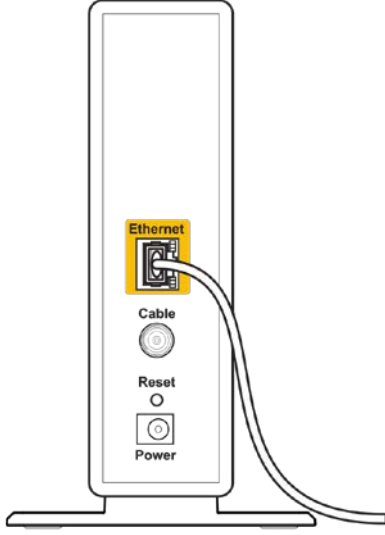
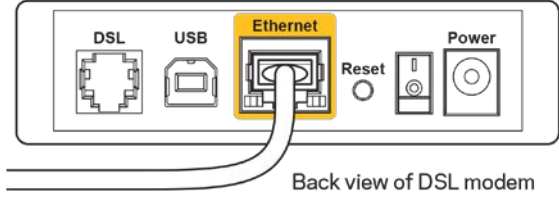

 <p>Back view of cable modem</p>	 <p>Back view of DSL modem</p>
<p>Wenn Sie ein Kabelmodem nutzen, vergewissern Sie sich, dass an dessen KABEL-Port das Koaxialkabel angeschlossen ist, das Sie von Ihrem ISP erhalten haben.</p>	<p>Wenn Sie stattdessen eine DSL-Verbindung nutzen, vergewissern Sie sich, dass die DSL-Leitung mit dem DSL-Port des Modems verbunden ist.</p>

- Falls der Computer bislang über ein USB-Kabel mit dem Modem verbunden war, stecken Sie das USB-Kabel aus.
- Installieren Sie den Router erneut.

## **Meldung „Kein Zugriff auf den Router“**

Es muss eine Verbindung zu Ihrem eigenen Netzwerk bestehen, damit Sie auf den Router zugreifen können. Wenn Sie über WLAN Zugriff auf das Internet haben, könnte das Problem darin bestehen, dass Sie aus Versehen eine Verbindung zu einem anderen WLAN hergestellt haben.

Gehen Sie auf Computern mit einem Windows-Betriebssystem folgendermaßen vor\*:

1. Klicken Sie in der Taskleiste auf das WLAN-Symbol. Daraufhin wird eine Liste aller verfügbaren Netzwerke angezeigt.

2. Klicken Sie auf den Namen Ihres Netzwerks. Klicken Sie auf Connect (Verbinden). Im Beispiel unten war der Computer mit einem anderen WLAN-Netzwerk mit dem Namen wraith\_5GHz verbunden. Der Name des WLAN-Netzwerks des Linksys EA8300 Routers, in diesem Beispiel Damaged\_Beez2.4, wird als ausgewählt angezeigt.



3. Wenn Sie aufgefordert werden, einen Netzwerkschlüssel einzugeben, geben Sie Ihr Kennwort (Sicherheitsschlüssel) in das Feld security key (Sicherheitsschlüssel) ein. Klicken Sie auf OK.
4. Ihr Computer stellt eine Verbindung mit dem Netzwerk her und Sie müssten auf den Router zugreifen können.

*\*Je nachdem, welche Windows-Version Sie nutzen, können die Formulierungen oder Symbole in diesen Schritten geringfügig von Ihrer Version abweichen.*

Gehen Sie auf Computern mit einem Mac-Betriebssystem folgendermaßen vor:

1. Klicken Sie in der Menüleiste am oberen Bildschirmrand auf das Symbol des WLAN-Netzwerks. Daraufhin wird eine Liste mit WLAN-Netzwerken angezeigt.
2. Im Beispiel unten war der Computer mit einem anderen WLAN-Netzwerk mit dem Namen wraith\_5GHz verbunden. Der Name des WLAN-Netzwerks des Linksys EA8300 Routers, in diesem Beispiel Damaged\_Beez2.4, wird als ausgewählt angezeigt.

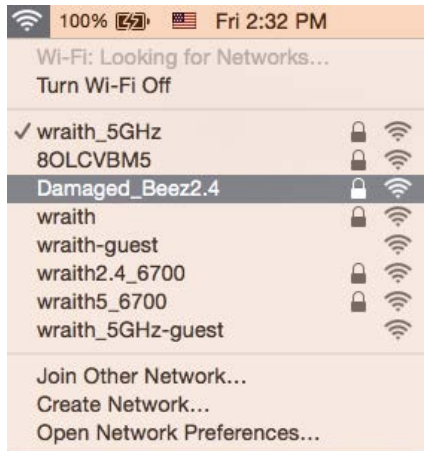

3. Klicken Sie auf den Namen des WLAN-Netzwerks Ihres Linksys Routers EA8300 (in diesem Beispiel Damaged\_Beez2.4).
4. Geben Sie das Kennwort (Sicherheitsschlüssel) Ihres WLAN-Netzwerks in das Feld *Password* (Kennwort) ein. Klicken Sie auf **OK**.

## Nach dem Setup

### Kein Zugriff auf das Internet

Wenn Verbindungsprobleme zwischen Internet und Router auftreten, erscheint im Webbrowser häufig die Meldung „[Internetadresse] kann nicht angezeigt werden“. Wenn Sie jedoch wissen, dass die Internetadresse stimmt, und es mit mehreren gültigen Internetadressen mit dem gleichen Ergebnis ausprobiert haben, könnte die Meldung bedeuten, dass ein Kommunikationsproblem zwischen Ihrem ISP oder Modem und dem Router besteht. Versuchen Sie Folgendes:

- Vergewissern Sie sich, dass die Netzwerk- und Stromkabel fest angeschlossen sind.
- Stellen Sie sicher, dass die Steckdose, an der Ihr Router eingesteckt ist, funktioniert.
- Starten Sie den Router neu.
- Erkundigen Sie sich bei Ihrem ISP nach möglichen Stromausfällen in Ihrem Gebiet.

Die gängigste Methode zur Fehlerbehebung an Ihrem Router besteht darin, ihn aus- und wieder einzuschalten. Dadurch können die benutzerdefinierten Einstellungen des Routers neu geladen werden, und andere Geräte (wie etwa das Modem) können den Router neu erkennen und mit ihm kommunizieren. Dieser Vorgang nennt sich Neustart oder Neubooten.

So starten Sie den Router mittels des Netzkabels neu:

1. Trennen Sie das Netzkabel von Router und Modem.
2. Warten Sie 10 Sekunden, und schließen Sie das Netzkabel dann wieder am Modem an. Stellen Sie sicher, dass es funktioniert (Strom fließt).
3. Warten Sie, bis die Aktivitätsanzeige des Modems aufgehört hat zu blinken (ungefähr zwei Minuten). Schließen Sie das Netzkabel wieder am Router an.

4. Warten Sie, bis das Linksys-Logo leuchtet. Warten Sie zwei Minuten, bevor Sie versuchen, über einen Computer eine Verbindung zum Internet herzustellen.

So starten Sie den Router über Linksys Smart Wi-Fi neu:

1. Melden Sie sich bei Linksys Smart Wi-Fi an. (siehe „Eine Verbindung zu Linksys Smart Wi-Fi herstellen“ auf Seite [11](#)).
2. Klicken Sie unter *Router Settings* (Routereinstellungen) auf *Troubleshooting* (Fehlerbehebung).
3. Klicken Sie auf die Registerkarte *Diagnostics* (Diagnose).
4. Klicken Sie unter *Reboot* (Neustart) auf Reboot (Neustart).



5. Klicken Sie auf „Yes“ (Ja). Der Router wird neu gestartet. Während des Neustarts werden alle verbundenen Geräte vom Internet getrennt und dann automatisch neu verbunden, sobald der Router wieder bereit ist.

## Linksys Smart Wi-Fi lässt sich nicht im Webbrowser öffnen

Die neuesten Versionen von Google Chrome™, Firefox®, Safari® (für Mac® und iPad®), Microsoft Edge und Internet Explorer® Version 8 und höher eignen sich für Linksys Smart Wi-Fi.

# Technische Daten

## Linksys EA8300

Modellbezeichnung	Max-Stream AC2200 MU-MIMO Tri-Band-Router
Modellnummer	EA8300
Switchport-Geschwindigkeit	10/100/1000 Mbit/s (Gigabit Ethernet)
Funkfrequenz	2,4 GHz und 5 GHz (2x)
Anzahl der Antennen	4 verstellbare externe Antennen (nicht abnehmbar)
Anschlüsse	USB 3.0, Ethernet (1-4), Internet, Strom
Tasten	WLAN, Wi-Fi Protected Setup, Ein/Aus, Reset
Leuchten	<b>Oberseite:</b> Erleuchtetes Linksys-Logo , Wi-Fi Protected Setup, Internetverbindung, Netzwerkkabelverbindung am Internetanschluss <b>Rückseite:</b> USB, Ethernet (1-4), Internet
UPnP	Wird unterstützt
Sicherheitsfunktionen	WEP, WPA2, RADIUS
Sicherheitsschlüssel/Bits	Verschlüsselung mit bis zu 128 Bit
Unterstützte Dateisysteme	FAT, NTFS und HFS+
Unterstützte Browser	Die neusten Versionen von Google Chrome™, Firefox®, Safari® (für Mac® und iPad®), Microsoft Edge und Internet Explorer® Version 8 und höher

## Betriebsbedingungen

Abmessungen	213,7 mm x 161,8 mm x 54,8 mm (ohne Antennen)
Gerätgewicht	608 g
Stromversorgung	12 V, 2 A
Zertifizierungen	FCC, IC, CE, Wi-Fi (a/b/g/n/ac)
Betriebstemperatur	0 - 40 °C
Lagertemperatur	-20 bis 60 °C
Betriebsfeuchtigkeit	10 bis 80 % relative Feuchtigkeit, nicht kondensierend
Lagerfeuchtigkeit	5 bis 90 %, nicht kondensierend

Technische Änderungen können ohne Vorankündigung vorgenommen werden.

Anmerkungen:

Zulassungs-, Garantie- und Sicherheitsinformationen finden Sie auf der im Lieferumfang des Routers enthaltenen CD oder unter [Linksys.com/support/EA8300](http://Linksys.com/support/EA8300).

Maximale Leistung gemäß den Spezifikationen des IEEE-Standards 802.11. Die tatsächliche Leistung kann variieren und geringere Kapazitäten des WLAN-Netzwerks, eine geringere Datendurchsatzrate und Reichweite sowie einen geringeren Empfangsbereich einschließen. Die Leistung wird durch zahlreiche Faktoren, Bedingungen und Variablen beeinflusst. Dazu zählen die Entfernung vom Access Point, das Datenverkehrsaufkommen im Netzwerk, Baustoffe und Konstruktionsweise von Gebäuden, das verwendete Betriebssystem, die Kombination der eingesetzten WLAN-Geräte, Interferenzen und weitere ungünstige Bedingungen.

BELKIN, LINKSYS und zahlreiche weitere Produktbezeichnungen und Logos sind Marken des Belkin-Konzerns. Alle anderen erwähnten Marken sind Eigentum ihrer jeweiligen Rechtsinhaber. Lizenzen und Hinweise zur Software Dritter, die auf diesem Produkt zum Einsatz kommt, finden Sie hier: <http://support.linksys.com/en-us/license>. Antworten auf Fragen und Informationen zum GPL-Quellcode finden Sie unter: <http://support.linksys.com/en-us/gplcodecenter>.

© 2017 Belkin International, Inc. und ihre Tochtergesellschaften. Alle Rechte vorbehalten.

**LINKSYS®**

Οδηγός Χρήσης

**MAX-STREAM™**

AC2200 MU-MIMO

ROUTER ΤΡΙΠΛΗΣ ΖΩΝΗΣ

Μοντέλο EA8300

# Περιεχόμενα

Επισκόπηση προϊόντος .....	3
Επάνω όψη .....	3
Ένδειξη κατάστασης συστήματος.....	4
Πίσω όψη.....	5
Πλαϊνή όψη.....	6
Ρυθμίσεις: Βασικά στοιχεία .....	7
Πού θα βρείτε περισσότερη βοήθεια .....	7
Πώς να εγκαταστήσετε το router σας .....	8
Πώς να χρησιμοποιήσετε το Linksys Smart Wi-Fi.....	11
Πώς να συνδεθείτε στο Linksys Smart Wi-Fi.....	11
Χάρτης δικτύου .....	12
Πρόσβαση επισκεπτών.....	12
Γονικός έλεγχος.....	13
Προτεραιότητα στα πολυμέσα .....	13
Έλεγχος ταχύτητας .....	14
Εξωτερική αποθήκευση.....	14
Συνδεσιμότητα.....	15
Αντιμετώπιση προβλημάτων .....	15
Ασύρματη σύνδεση.....	16
Ασφάλεια.....	16
Αντιμετώπιση προβλημάτων .....	17
Το router σας δεν εγκαταστάθηκε επιτυχώς.....	17
Μήνυμα « <i>Το καλώδιο Internet δεν είναι συνδεδεμένο (Your Internet cable is not plugged in)</i> ».....	18
Μήνυμα « <i>Δεν είναι δυνατή η πρόσβαση στο router σας (Cannot access your router)</i> » .....	19
Μετά την εγκατάσταση .....	21
Δεν είναι διαθέσιμο το Internet .....	21
Το Linksys Smart Wi-Fi δεν ανοίγει στο πρόγραμμα περιήγησης Web .....	22
Τεχνικά χαρακτηριστικά .....	23
Linksys EA8300 .....	23
Χαρακτηριστικά περιβάλλοντος λειτουργίας.....	23



# Επισκόπηση προϊόντος

Επάνω όψη

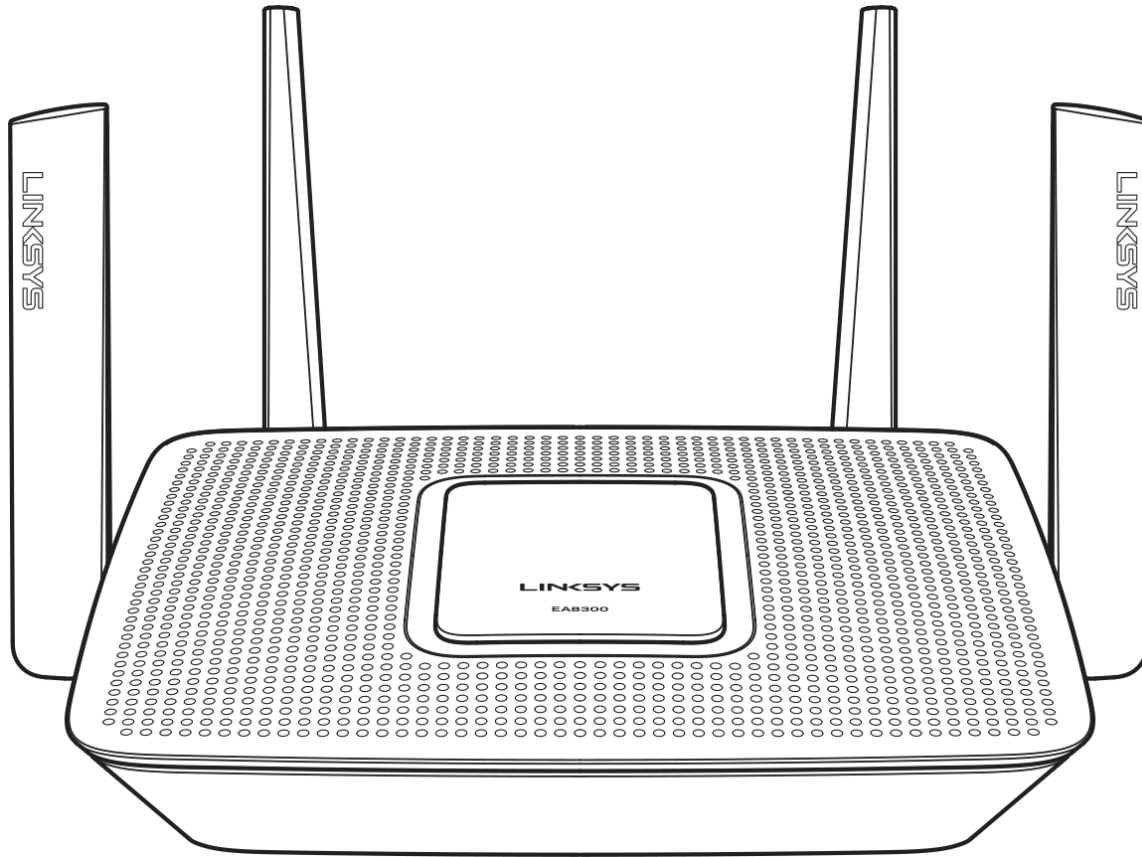

## Ένδειξη κατάστασης συστήματος

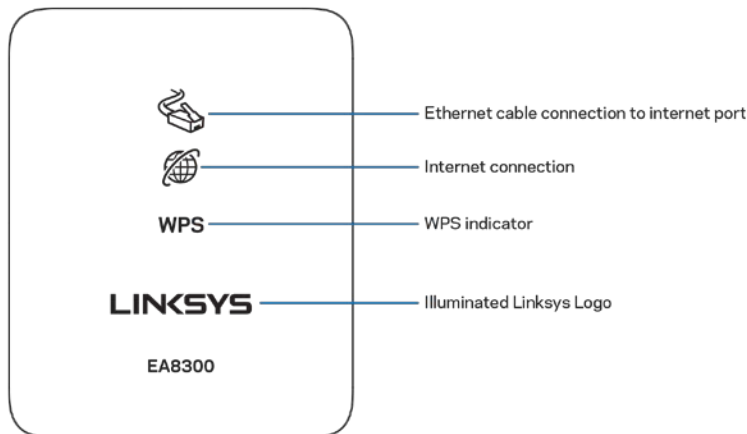

Σύνδεση μέσω καλωδίου Ethernet στη θύρα Internet—Όταν είναι αναμμένη (πορτοκαλί), υποδεικνύει πρόβλημα με το καλώδιο δικτύου που είναι συνδεδεμένο στη θύρα Internet (WAN).

Σύνδεση Internet—Όταν είναι αναμμένη (πορτοκαλί), υποδεικνύει πως το router δεν έχει πρόσβαση στο internet.

Ένδειξη WPS (Wi-Fi Protected Setup™) —Η λυχνία WPS διαθέτει τέσσερις καταστάσεις:

Απενεργοποιημένη	Δεν υπάρχει δραστηριότητα Wi-Fi Protected Setup
Αναβοσβήνει, λευκό χρώμα	Η διαδικασία Wi-Fi Protected Setup βρίσκεται σε εξέλιξη
Σταθερά αναμμένη, λευκό χρώμα	Η διαδικασία Wi-Fi Protected Setup ολοκληρώθηκε με επιτυχία, παραμένει αναμμένη για πέντε δευτερόλεπτα
Αναβοσβήνει πορτοκαλί	Σφάλμα Wi-Fi Protected Setup, αναβοσβήνει για ένα λεπτό και μετά σβήνει

Φωτισμένο λογότυπο Linksys—Το λογότυπο αναβοσβήνει κατά την εκκίνηση του router. Όταν το λογότυπο είναι σταθερά αναμμένο με λευκό χρώμα, το router είναι ενεργοποιημένο και λειτουργεί σωστά.

## Πίσω όψη

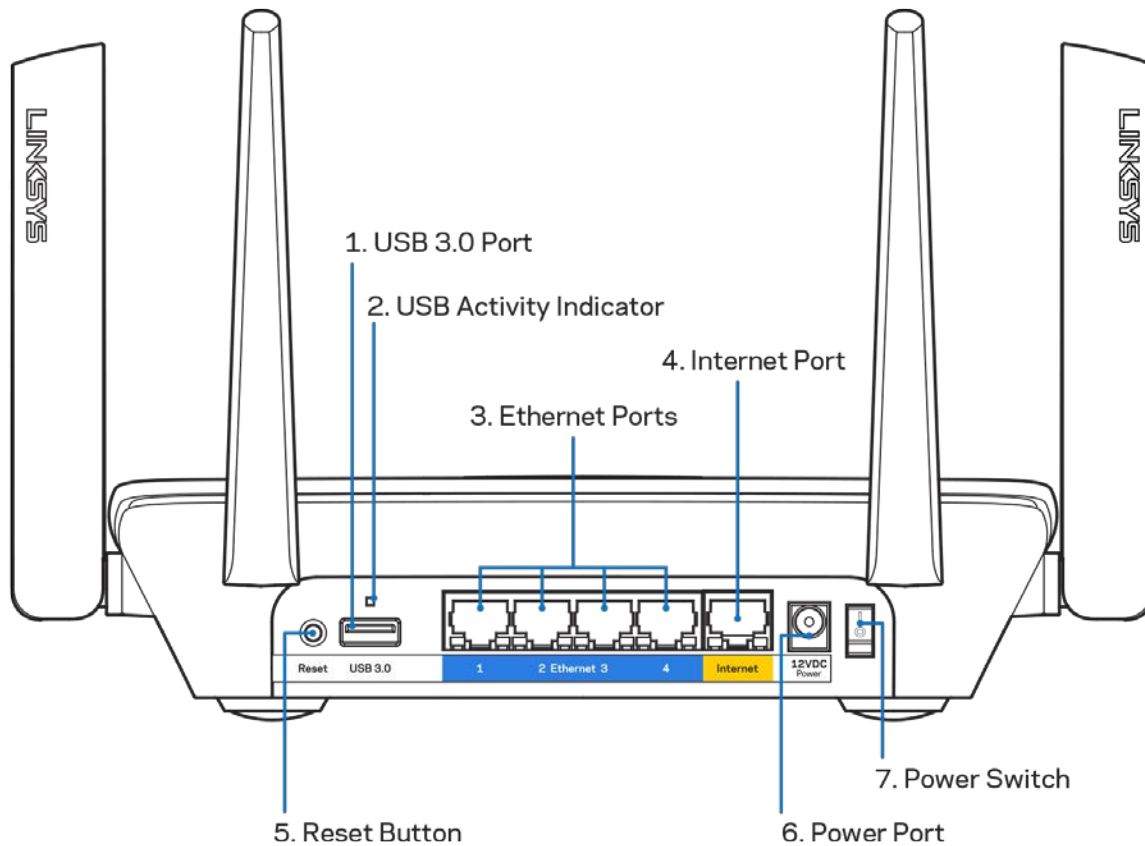

Θύρα USB 3.0 (1)—Συνδέστε και μοιραστείτε μονάδες δίσκου USB στο δίκτυό σας ή στο Internet.

Ενδεικτική λυχνία δραστηριότητας USB (2)—Όταν είναι αναμμένη υποδεικνύει μεταφορά δεδομένων προς/από εξωτερικές συσκευές.

Θύρες Ethernet (3)—Συνδέστε καλώδια ethernet σε αυτές τις μπλε θύρες gigabit (10/100/1000) και το άλλο άκρο τους στις ενσύρματες συσκευές στο δίκτυό σας.

Σημείωση—Για καλύτερη απόδοση, χρησιμοποιήστε καλώδια κατηγορίας CAT5e ή υψηλότερης στις θύρες Ethernet.

Θύρα Internet (4)—Συνδέστε ένα καλώδιο ethernet σε αυτήν την κίτρινη θύρα gigabit (10/100/1000) και το άλλο άκρο σε ένα καλωδιακό/DSL μόντεμ ευρυζωνικού internet ή μόντεμ οπτικής ίνας.

Σημείωση—Για καλύτερη απόδοση, χρησιμοποιήστε καλώδια κατηγορίας CAT5e ή υψηλότερης στη θύρα Internet.

Κουμπί επαναφοράς (5)—Κρατήστε το πατημένο μέχρι να σβήσει το φωτισμένο λογότυπο Linksys για να κάνετε επαναφορά του router στις εργοστασιακές ρυθμίσεις. Μπορείτε επίσης να επαναφέρετε τις εργοστασιακές ρυθμίσεις μέσω του Linksys Smart Wi-Fi μέσω του Internet ή της εφαρμογής για φορητές συσκευές.

Θύρα τροφοδοσίας (6)—Συνδέστε τον παρεχόμενο μετασχηματιστή AC.

Διακόπτης τροφοδοσίας (7)— Πατήστε | (ενεργοποίηση) για να ενεργοποιήσετε το router.

## Πλαϊνή όψη

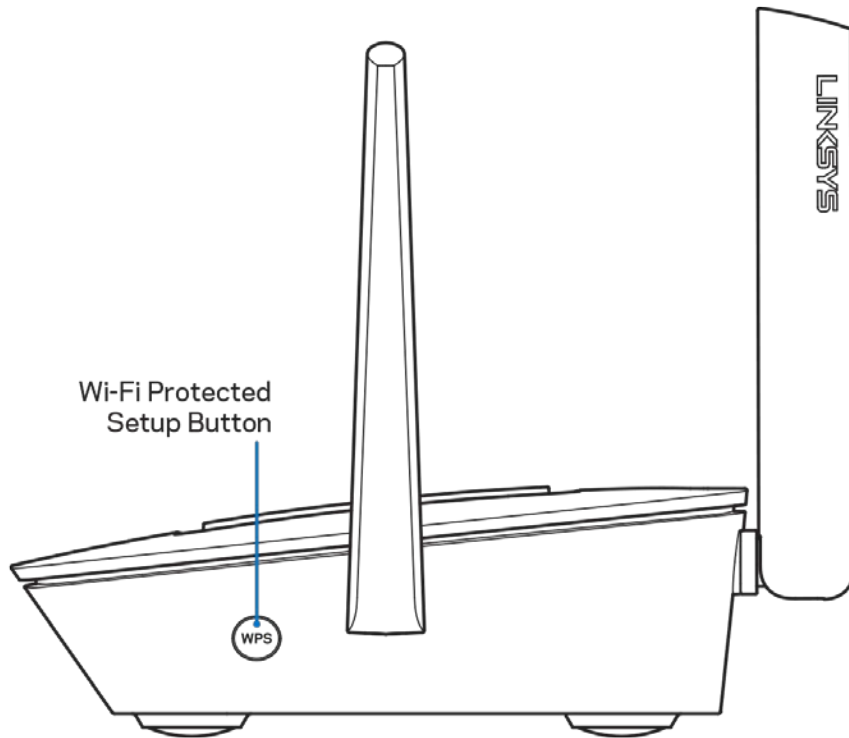

Κουμπί Wi-Fi Protected Setup™—Πατήστε το για σύνδεση με συσκευές δικτύου που υποστηρίζουν WPS.

# Ρυθμίσεις: Βασικά στοιχεία

## Πού θα βρείτε περισσότερη βοήθεια

Εκτός από αυτόν το Οδηγό χρήσης, μπορείτε να βρείτε βοήθεια στις παρακάτω τοποθεσίες:

- [Linksys.com/support/EA8300](http://Linksys.com/support/EA8300) (τεκμηρίωση, λήψεις, συχνές ερωτήσεις, τεχνική υποστήριξη, ζωντανή συνομιλία, φόρουμ)
- Βοήθεια για το Linksys Smart Wi-Fi (συνδεθείτε στο Linksys Smart Wi-Fi, κι έπειτα κάντε κλικ στη Βοήθεια (Help) στο επάνω μέρος της οθόνης)

The screenshot shows the Linksys Smart Wi-Fi app interface. At the top, there is a navigation bar with 'App Center', 'Help' (highlighted with a red circle), 'Linksys15895', and 'Christopher K.'. The main interface is divided into several sections: 'Smart Wi-Fi Tools' (Network Map, Guest Access, Parental Controls, Media Prioritization, Speed Test, External Storage), 'Router Settings' (Connectivity, Troubleshooting, Wireless, Security), and a central dashboard with widgets for Network Status, Linksys Home Networking, Wireless, Guest Access, Network Map, Parental Controls, External Storage, and Media Prioritization. A 'Help' dialog box is open at the bottom, titled 'Using Linksys Smart Wi-Fi'. It contains introductory text and a 'Help Categories' list with the following items: Linksys Smart Wi-Fi, Device List, Guest Access, Parental Controls, Media Prioritization, Speed Test, External Storage, and Connectivity. An 'Ok' button is at the bottom right of the dialog.

Σημείωση—Οι άδειες και οι γνωστοποιήσεις για λογισμικό τρίτων εταιρειών που χρησιμοποιείται σε αυτό το προϊόν είναι διαθέσιμες στη διεύθυνση <http://support.linksys.com/en-us/license>. Επικοινωνήστε με το <http://support.linksys.com/en-us/gplcodecenter> για ερωτήσεις ή σχετικά με αιτήματα πηγαίου κώδικα GPL.

## Πώς να εγκαταστήσετε το router σας

1. Για να ολοκληρώσετε την εγκατάσταση, θα χρειαστείτε έναν υπολογιστή ώστε να επισκεφτείτε τον ιστότοπο <http://LinksysSmartWiFi.com> από ένα πρόγραμμα περιήγησης Web.
2. Ταυτοποιήστε τον εξοπλισμό σας.

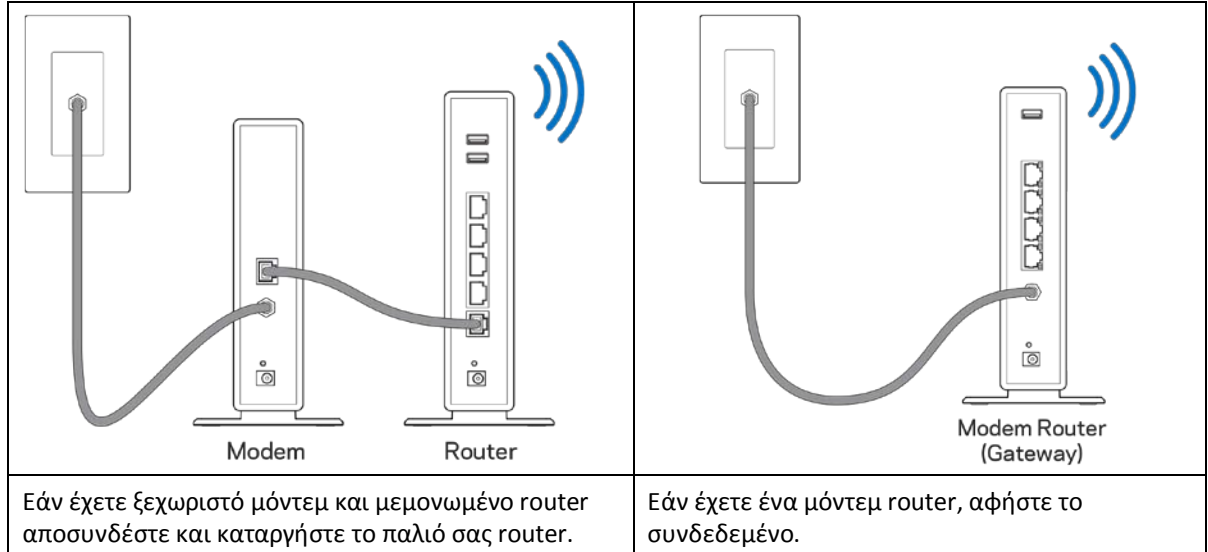

3. Στρέψτε τις κεραίες προς τα πάνω και συνδέστε το router σε μια πηγή τροφοδοσίας. Βεβαιωθείτε ότι ο διακόπτης βρίσκεται στη θέση I (ενεργοποίηση).
4. Συνδέστε το router σας στο μόντεμ σας ή στο μόντεμ router. Συνδέστε το ένα άκρο του καλωδίου Internet στην κίτρινη θύρα Internet του νέου σας router. Εάν έχετε μόντεμ, συνδέστε το άλλο άκρο στη θύρα Ethernet (LAN) στο μόντεμ. Εάν έχετε μόντεμ router, συνδέστε το σε οποιαδήποτε διαθέσιμη θύρα.
5. Περιμένετε έως ότου η φωτεινή λυχνία Linksys στο επάνω μέρος του router σας σταματήσει να αναβοσβήνει και να παραμείνει σταθερά λευκή.
6. Συνδεθείτε στο όνομα του Wi-Fi που εμφανίζεται στον Οδηγό γρήγορης εκκίνησης που συνόδευε το router σας. (Μπορείτε να αλλάξετε αυτά τα στοιχεία αργότερα.) Εάν χρειάζεστε βοήθεια για να συνδεθείτε στο δίκτυο, ανατρέξτε στην τεκμηρίωση της συσκευής σας στο [linksys.com/support/EA8300](http://linksys.com/support/EA8300).

**Σημείωση—**Δεν θα έχετε πρόσβαση στο Internet έως ότου να ολοκληρωθεί η ρύθμιση του router.

7. Εισάγετε τη διεύθυνση <http://LinksysSmartWiFi.com> σε ένα πρόγραμμα περιήγησης web. Ακολουθήστε τις οδηγίες στην οθόνη για να ολοκληρώσετε την εγκατάσταση του router. Μπορείτε επίσης να πληκτρολογήσετε 192.168.1.1 σε ένα πρόγραμμα περιήγησης για να ξεκινήσετε τις ρυθμίσεις.

Στο τέλος της διαδικασίας εγκατάστασης, ακολουθήστε τις οδηγίες στην οθόνη για να ρυθμίσετε το λογαριασμό Linksys Smart Wi-Fi σας. Χρησιμοποιήστε το Linksys Smart Wi-Fi για να διαμορφώσετε το router σας από οποιονδήποτε υπολογιστή με σύνδεση στο Internet.

Διαχείριση ρυθμίσεων του router σας:

- Αλλαγή ονόματος και κωδικού πρόσβασης του router
- Ρύθμιση πρόσβασης επισκεπτών
- Διαμόρφωση γονικών ελέγχων
- Σύνδεση συσκευών στο ασύρματο δίκτυό σας
- Έλεγχος της ταχύτητας σύνδεσης στο Internet

Note—Κατά τη ρύθμιση του λογαριασμού Linksys Smart Wi-Fi, θα λάβετε ένα e-mail επαλήθευσης. Από το οικιακό σας δίκτυο, κάντε κλικ στη σύνδεση στο e-mail για να συσχετίσετε το router σας με το λογαριασμό σας στο Linksys Smart Wi-Fi.

Συμβουλή—Εκτυπώστε αυτήν τη σελίδα και καταγράψτε τις ρυθμίσεις του router και του λογαριασμού σας στον πίνακα για μελλοντική αναφορά. Αποθηκεύστε τις σημειώσεις σας σε ένα ασφαλές μέρος.

Όνομα ασύρματου δικτύου 2.4 GHz	
Κωδικός πρόσβασης Wi-Fi	
Όνομα ασύρματου δικτύου 5 GHz <sub>1</sub>	
Κωδικός πρόσβασης Wi-Fi	
Όνομα ασύρματου δικτύου 5 GHz <sub>2</sub>	
Κωδικός πρόσβασης Wi-Fi	
Κωδικός πρόσβασης router	
Όνομα ασύρματου δικτύου επισκεπτών 2.4 GHz	
Όνομα ασύρματου δικτύου επισκεπτών 5GHz	
Κωδικός πρόσβασης ασύρματου δικτύου επισκεπτών Wi-Fi (Μοιράζονται τον ίδιο κωδικό πρόσβασης και τα δύο.)	
Όνομα χρήστη Linksys Smart Wi-Fi	
Κωδικός πρόσβασης Linksys Smart Wi-Fi	



# Πώς να χρησιμοποιήσετε το Linksys Smart Wi-Fi

Μπορείτε να διαχειριστείτε το router σας από οπουδήποτε στον κόσμο χρησιμοποιώντας το Linksys Smart Wi-Fi, αλλά μπορείτε επίσης και να το διαχειριστείτε απευθείας από το οικιακό σας δίκτυο. Το Linksys Smart Wi-Fi ίσως να είναι διαθέσιμο και για τη φορητή σας συσκευή. Δείτε το κατάστημα εφαρμογών της συσκευής σας για περισσότερες πληροφορίες.

## Πώς να συνδεθείτε στο Linksys Smart Wi-Fi

Για να συνδεθείτε με το Linksys Smart Wi-Fi:

1. Ανοίξετε το πρόγραμμα περιήγησης Web του υπολογιστή σας.
2. Μεταβείτε στη διεύθυνση <http://LinksysSmartWiFi.com> και συνδεθείτε στο λογαριασμό σας.

Εάν δεν μπορείτε να θυμηθείτε τον κωδικό πρόσβασής σας, κάντε κλικ στο *Forgot your password?* (Ξεχάσατε τον κωδικό πρόσβασής σας;) και ακολουθήστε τις οδηγίες στην οθόνη για την ανάκτησή του.

## Χάρτης δικτύου

Επιτρέπει την εμφάνιση και τη διαχείριση όλων των συσκευών του δικτύου που είναι συνδεδεμένες στο router σας. Μπορείτε να προβάλετε τις συσκευές στο κύριο δίκτυο και στο δίκτυο επισκεπτών, ή να εμφανίσετε πληροφορίες για κάθε συσκευή.



## Πρόσβαση επισκεπτών

Σας επιτρέπει να δημιουργήσετε και να παρακολουθείτε ένα δίκτυο μέσω του οποίου έχουν πρόσβαση στο διαδίκτυο οι επισκέπτες, χωρίς να εκθέτετε προσωπικές σας πληροφορίες.

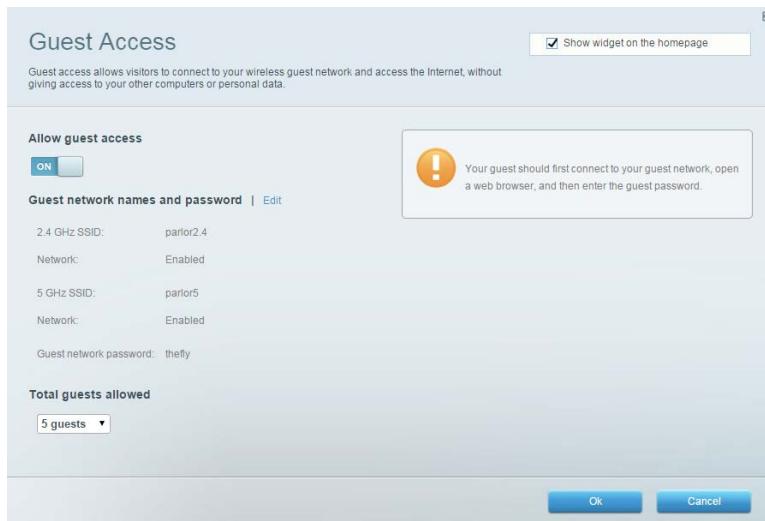

## Γονικός έλεγχος

Επιτρέπει τον αποκλεισμό τοποθεσιών στο web και τη ρύθμιση των ωρών πρόσβασης στο Internet.

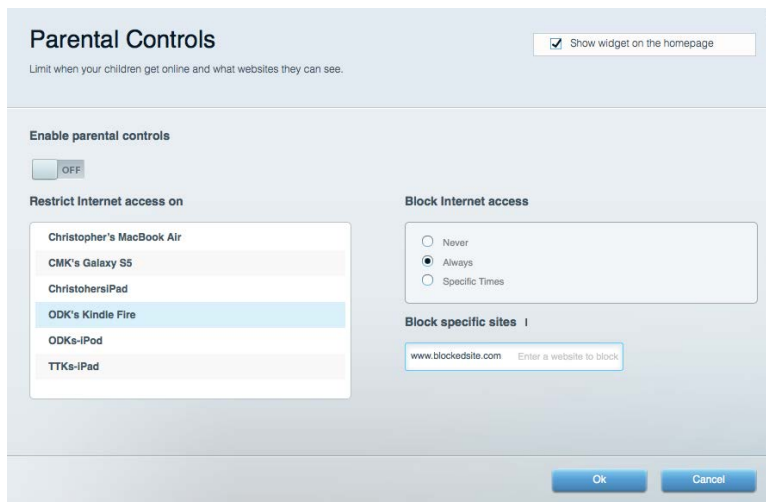

## Προτεραιότητα στα πολυμέσα

Επιτρέπει να ορίσετε ποιες συσκευές και εφαρμογές θα έχουν μεγαλύτερη προτεραιότητα για την κίνηση του δικτύου σας.

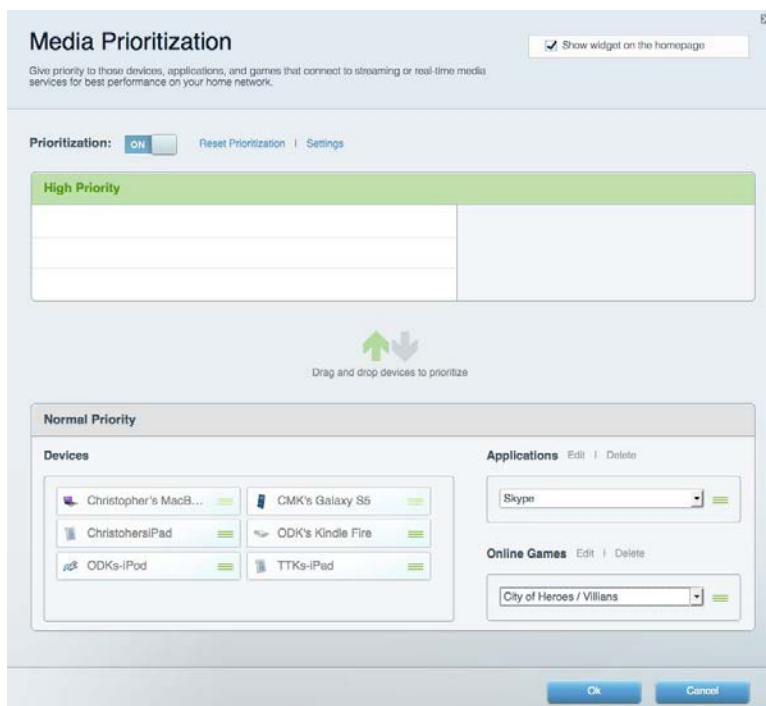

## Έλεγχος ταχύτητας

Επιτρέπει τον έλεγχο της ταχύτητας σύνδεσης του δικτύου σας στο Internet.

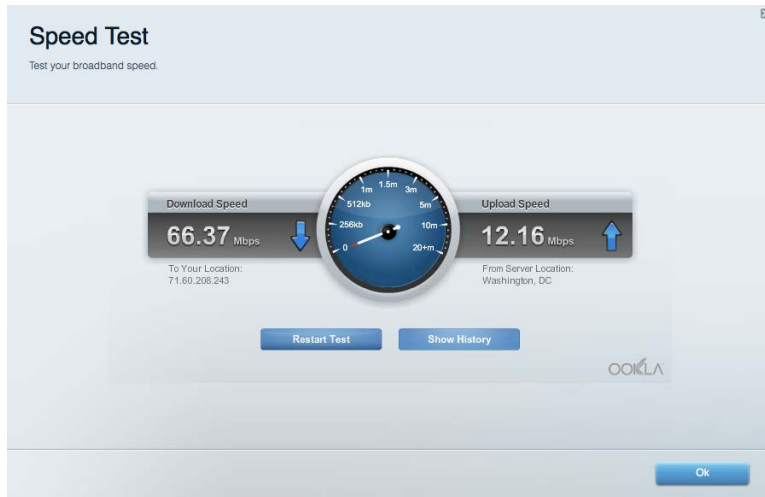

## Εξωτερική αποθήκευση

Επιτρέπει την πρόσβαση σε έναν συνδεδεμένο δίσκο USB (δεν παρέχεται) και τη ρύθμιση κοινής χρήσης αρχείων, διακομιστή πολυμέσων και πρόσβασης μέσω FTP.

The screenshot shows the 'External Storage' configuration page with the following settings:

- External Storage Drive:** Volume name: ROUND DRIVE. Space used: 856 MB used of 969 MB total. Buttons: 'Safely remove drive', 'Refresh'.
- Secure Folder Access:** Status: OFF. Note: Any user can access content via shared folders. Access paths: PC access (File explorer): \\192.168.1.1; Mac access (Finder): smb://192.168.1.1
- FTP Server:** Status: OFF. Note: Content is not accessible to any user via FTP. FTP server: Disabled.
- Media Server (DLNA):** Status: ON. Note: Media content is accessible to DLNA clients. DLNA server: EA6050.

## Συνδεσιμότητα

Επιτρέπει τη διαμόρφωση βασικών ρυθμίσεων δικτύου και ρυθμίσεων για προχωρημένους.

The screenshot shows the 'Connectivity' settings page. It includes tabs for 'Basic', 'Internet Settings', 'Local Network', 'Advanced Routing', 'VLAN', and 'Administration'. The 'Basic' tab is active, showing network name and password settings for 2.4 GHz and 5 GHz networks, router password, and options for firmware updates, time zone, and activity lights.

**Connectivity**  
View and change router settings

Basic | Internet Settings | Local Network | Advanced Routing | VLAN | Administration

**Network Name and Password** | Edit

2.4 GHz network name: arachnid  
Network password: peterparker

5 GHz + 5 GHz<sub>2</sub> network name: arachnid\_5GHz  
Network password: peterparker

**Router Password** | Edit

Router password: \*\*\*\*\*

**Router Firmware Update**

Automatic (Current Version: 1.1.5.164615)  
[Check for Updates](#)

**Time Zone**

(GMT-05:00) Eastern Time (USA & Canada) ▾  
 Automatically adjust for Daylight Savings Time

**Activity Lights**

ON  
Enable/disable activity lights. Power light will remain on.

[Ok](#) [Cancel](#) [Apply](#)

## Αντιμετώπιση προβλημάτων

Επιτρέπει τη διάγνωση των προβλημάτων του router και τον έλεγχο της κατάστασης του δικτύου.

The screenshot shows the 'Troubleshooting' page. It includes tabs for 'Status', 'Diagnostics', and 'Logs'. The 'Diagnostics' tab is active, showing options for ping, trace route, reboot, router configuration, router firmware, internet address, and factory reset.

**Troubleshooting**  
Troubleshoot router settings

Status | Diagnostics | Logs

**Ping IPv4**

IP or host name:   
Number to ping: 5 ▾  
[Start to Ping](#)

**Trace route**

IP or host name:   
[Start to Traceroute](#)

**Reboot**

[Reboot the router](#)

**Router configuration**

[Backup](#) [Restore](#)

**Router Firmware**

[Restore previous firmware](#)

**Internet Address:**

IPv4: 10.0.0.253 [Release and Renew](#)  
IPv6: 2601:0540:c000:0019:0000:0000:0000:314e [Release and Renew](#)

**Factory reset**

[Reset to factory default settings](#)

[Ok](#)

## Ασύρματη σύνδεση

Σας επιτρέπει να προβάλλετε και να αλλάξετε το ασύρματο δίκτυο του router σας. Μπορείτε να αλλάξετε τα ονόματα δικτύου, τη λειτουργία ασφαλείας, τον κωδικό πρόσβασης, το φιλτράρισμα διευθύνσεων MAC και να συνδέσετε συσκευές με χρήση του Wi-Fi Protected Setup.

Wireless

View and change router settings

Wireless | MAC Filtering | Wi-Fi Protected Setup

Smart Connect:  5 GHz band steering  OFF

Network name: arachnid 2.4 GHz Network: ON

Password: peterparker Broadcast SSID: Yes Channel: Auto

Security mode: WPA2/WPA Mixed Pt Network mode: Mixed Channel width: Auto

Network name: arachnid\_5GHz 5 GHz<sub>1</sub> + 5 GHz<sub>2</sub> Network: ON

Password: peterparker Broadcast SSID: Yes Channel: Auto

Security mode: WPA2/WPA Mixed Pt Network mode: Auto Channel width: Auto

Ok Cancel Apply

## Ασφάλεια

Σας επιτρέπει να προβάλλετε και να αλλάξετε την ασφάλεια ασύρματου δικτύου του router σας. Μπορείτε να διαμορφώσετε το τείχος προστασίας, τις ρυθμίσεις VPN, αλλά και να δημιουργήσετε εξατομικευμένες ρυθμίσεις για εφαρμογές και παιχνίδια.

Security

View and change router settings

Firewall | DMZ | Apps and Gaming

**Firewall**

IPv4 SPI firewall protection  Enabled

IPv6 SPI firewall protection  Enabled

**Internet filters**

Filter anonymous Internet requests

Filter multicast

Filter Internet NAT redirection

Filter ident (Port 113)

**VPN Passthrough**

IPSec Passthrough  Enabled

PPTP Passthrough  Enabled

L2TP Passthrough  Enabled

**IPv6 Port Services**

Description	Protocol	IPv6 Address	Allow	Enabled	

Add IPv6 Firewall Setting

Ok Cancel Apply

# Αντιμετώπιση προβλημάτων

Μπορείτε να λάβετε περισσότερη βοήθεια από τη βραβευμένη υποστήριξη πελατών μας στη διεύθυνση [linksys.com/support/EA8300](http://linksys.com/support/EA8300).

## Το router σας δεν εγκαταστάθηκε επιτυχώς

Εάν το Linksys Smart Wi-Fi δεν ολοκλήρωσε την εγκατάσταση, μπορείτε να δοκιμάσετε τα παρακάτω:

- Πατήστε παρατεταμένα το κουμπί Reset (Επαναφορά) στο router σας με έναν συνδετήρα ή με μία πινέζα έως ότου απενεργοποιηθεί το φωτεινό λογότυπο Linksys και οι μπλε ενδείξεις MU-MIMO αρχίσουν να αναβοσβήνουν (περίπου 10 δευτερόλεπτα). Εγκαταστήστε ξανά το router.

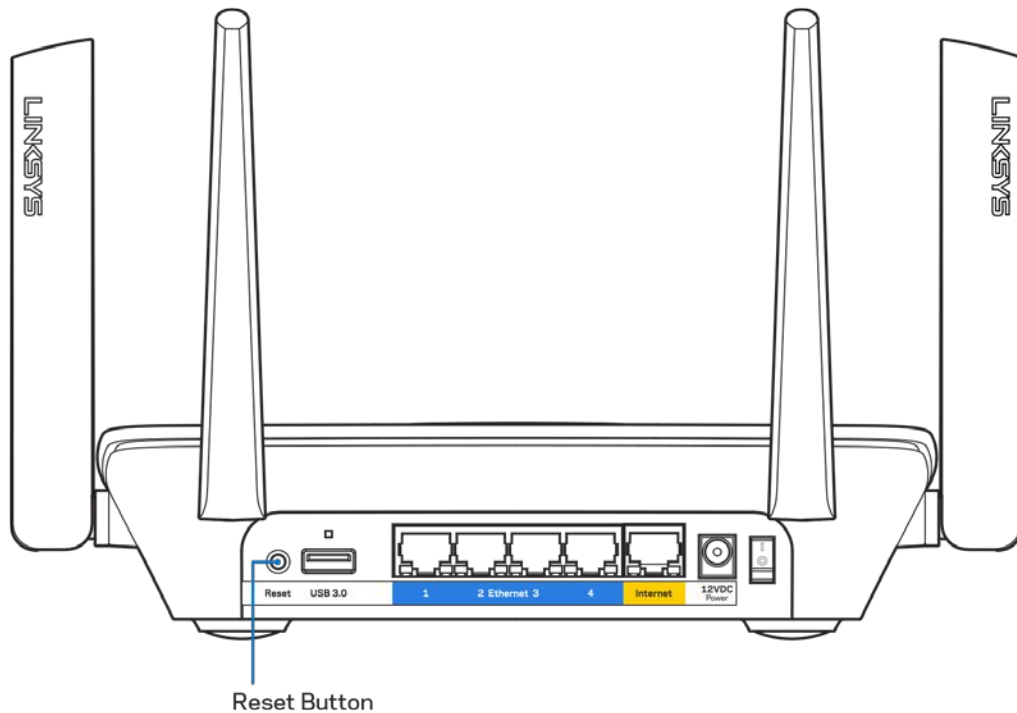

- Απενεργοποιήστε προσωρινά το τείχος προστασίας του υπολογιστή σας (ανατρέξτε στις οδηγίες του λογισμικού ασφαλείας για βοήθεια). Εγκαταστήστε ξανά το router.
- Εάν έχετε άλλο υπολογιστή, χρησιμοποιήστε εκείνον τον υπολογιστή για να εγκαταστήσετε ξανά το router.

## Μήνυμα «Το καλώδιο Internet δεν είναι συνδεδεμένο (Your Internet cable is not plugged in)»

Αν εμφανιστεί το μήνυμα «Το καλώδιο Internet δεν είναι συνδεδεμένο» ενώ προσπαθείτε να εγκαταστήσετε το router σας, ακολουθήστε τα παρακάτω βήματα αντιμετώπισης προβλημάτων.

- Βεβαιωθείτε πως έχετε συνδέσει καλά ένα καλώδιο ethernet ή διαδικτύου (ή ένα καλώδιο όπως εκείνο που συνοδεύει το router σας) στην κίτρινη θύρα διαδικτύου στο πίσω μέρος του router και στην κατάλληλη θύρα του μόντεμ σας. Αυτή η θύρα στο μόντεμ συνήθως ονομάζεται Ethernet.

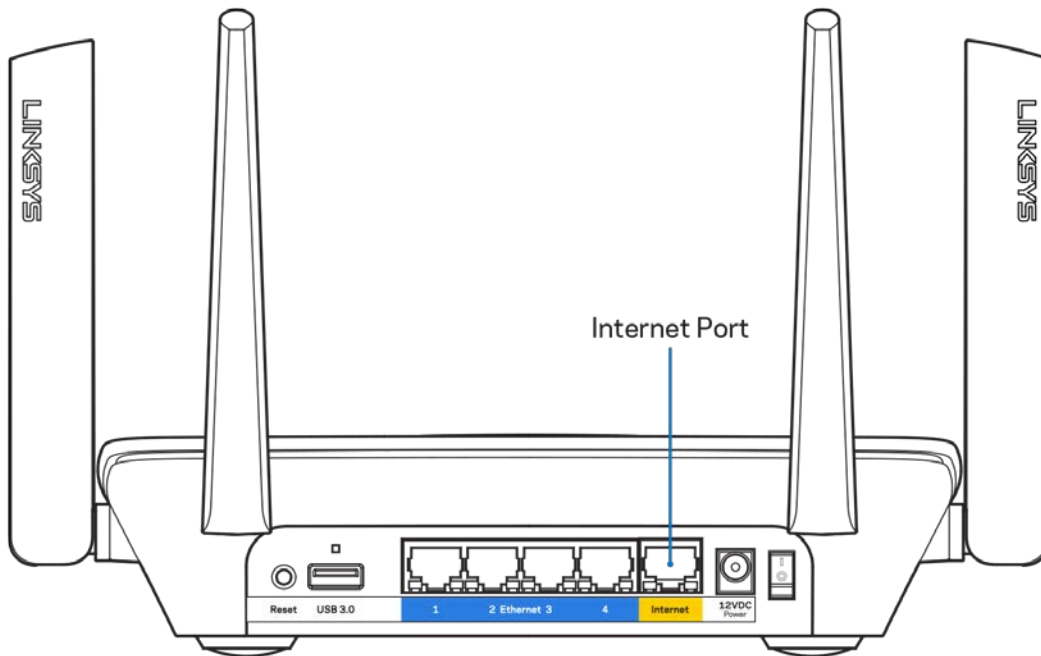

- Βεβαιωθείτε ότι το μόντεμ σας είναι συνδεδεμένο στο ρεύμα και ενεργοποιημένο. Αν έχει διακόπτη ενεργοποίησης/απενεργοποίησης, βεβαιωθείτε ότι βρίσκεται στη θέση ON ή I (και όχι στη θέση O).

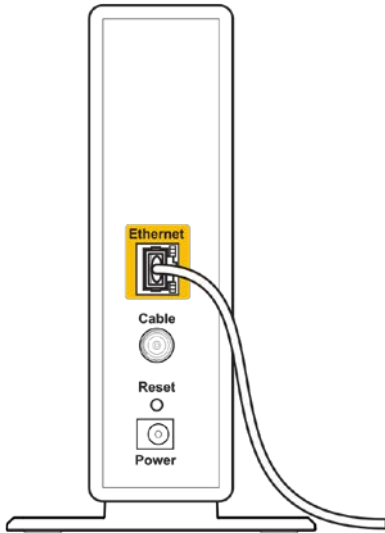
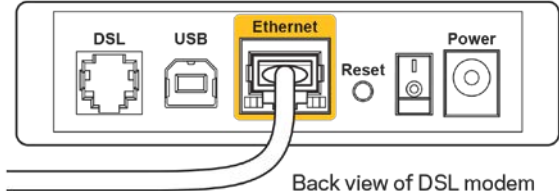

 <p>Back view of cable modem</p>	 <p>Back view of DSL modem</p>
<p>Αν η υπηρεσία Internet είναι καλωδιακή, βεβαιωθείτε ότι το ομοαξονικό καλώδιο που παρέχεται από τον ISP σας είναι συνδεδεμένο στη θύρα CABLE του μόντεμ σας.</p>	<p>Εάν η υπηρεσία Internet είναι DSL βεβαιωθείτε ότι η γραμμή τηλεφώνου DSL είναι συνδεδεμένη στη θύρα DSL του μόντεμ.</p>

- Αν ο υπολογιστής σας ήταν προηγουμένως συνδεδεμένος στο μόντεμ σας μέσω καλωδίου USB, απασχόησε το καλώδιο USB.
- Εγκαταστήστε ξανά το router.

## Μήνυμα «Δεν είναι δυνατή η πρόσβαση στο router σας (Cannot access your router)»

Για να αποκτήσετε πρόσβαση στο router σας, πρέπει ο υπολογιστής σας να είναι συνδεδεμένος στο δικό σας δίκτυο. Εάν έχετε ασύρματη πρόσβαση στο Internet, το πρόβλημα ενδεχομένως να είναι ότι έχετε συνδεθεί κατά λάθος σε ένα διαφορετικό ασύρματο δίκτυο.

Για να διορθώσετε το πρόβλημα σε υπολογιστές με Windows, ακολουθήστε τα παρακάτω βήματα\*:

1. Κάντε κλικ στο εικονίδιο ασύρματου δικτύου στην περιοχή ειδοποιήσεων. Εμφανίζεται μια λίστα με τα διαθέσιμα δίκτυα.

2. Κάντε κλικ στο όνομα του δικού σας δικτύου. Κάντε κλικ στη Σύνδεση. Στο παρακάτω παράδειγμα, ο υπολογιστής ήταν συνδεδεμένος σε άλλο ασύρματο δίκτυο με το όνομα wraith\_5GHz. Το όνομα του ασύρματου δικτύου του Linksys EA8300 router, το οποίο σε αυτό το παράδειγμα είναι Damaged\_Beez2.4, εμφανίζεται επιλεγμένο.



3. Αν σας ζητηθεί να εισάγετε κλειδί ασφαλείας δικτύου, πληκτρολογήστε τον κωδικό πρόσβασης σας (Κλειδί ασφαλείας) στο πεδίο κλειδί ασφαλείας δικτύου. Κάντε κλικ στο OK.
4. Ο υπολογιστής σας θα συνδεθεί στο δίκτυο και θα πρέπει να μπορείτε να προσπελάσετε το router.

\*Ανάλογα με την έκδοση των Windows σας, ενδέχεται να υπάρχουν διαφορές στη διατύπωση ή στα εικονίδια σε αυτά τα βήματα.

Για να διορθώσετε το πρόβλημα σε υπολογιστές Mac, κάντε τις παρακάτω ενέργειες:

1. Στη γραμμή μενού στο πάνω μέρος της οθόνης, κάντε κλικ στο εικονίδιο Wi-Fi. Εμφανίζεται μια λίστα με τα διαθέσιμα δίκτυα.
2. Στο παρακάτω παράδειγμα, ο υπολογιστής ήταν συνδεδεμένος σε άλλο ασύρματο δίκτυο με το όνομα wraith\_5GHz. Το όνομα του ασύρματου δικτύου του Linksys EA8300 router, το οποίο σε αυτό το παράδειγμα είναι Damaged\_Beez2.4, εμφανίζεται επιλεγμένο.

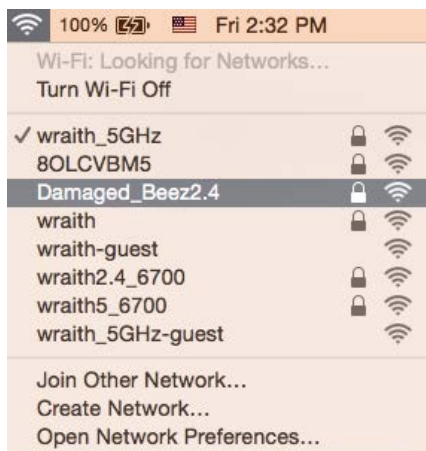

3. Κάντε κλικ στο όνομα ασύρματου δικτύου του Linksys EA8300 router σας (Damaged\_Beez2.4 σε αυτό το παράδειγμα).
4. Πληκτρολογήστε τον κωδικό πρόσβασης ασύρματου δικτύου (Κλειδί ασφαλείας) στο πεδίο Κωδικός πρόσβασης. Κάντε κλικ στο OK.

## Μετά την εγκατάσταση

### Δεν είναι διαθέσιμο το Internet

Εάν υπάρχει δυσκολία στην επικοινωνία ανάμεσα στο διαδίκτυο και το router σας, το πρόβλημα ίσως εμφανίζεται ως ένα μήνυμα "Δεν είναι δυνατή η εύρεση της διεύθυνσης [διαδικτυακή διεύθυνση]" στο πρόγραμμα περιήγησης Web. Εάν γνωρίζετε πως η διεύθυνση Internet είναι σωστή και εάν έχετε δοκιμάσει αρκετές έγκυρες διευθύνσεις Internet με το ίδιο αποτέλεσμα, το μήνυμα ίσως σημαίνει πως υπάρχει πρόβλημα με τον ISP σας ή με το μόντεμ που επικοινωνεί με το router σας. Δοκιμάστε τα ακόλουθα:

- Βεβαιωθείτε πως τα καλώδια δικτύου και τροφοδοσίας έχουν συνδεθεί καλά.
- Βεβαιωθείτε πως η πρίζα τροφοδοσίας στην οποία είναι συνδεδεμένο το router σας έχει ρεύμα.
- Κάντε επανεκκίνηση του router σας.
- Επικοινωνήστε με τον ISP σας και ρωτήστε εάν υπάρχουν προβλήματα συνδέσεων στην περιοχή σας.

Η πιο συνηθισμένη μέθοδος αντιμετώπισης των προβλημάτων του router σας είναι να το απενεργοποιήσετε και να το ενεργοποιήσετε ξανά. Το router σας μπορεί στη συνέχεια να επαναφορτώσει τις προσαρμοσμένες ρυθμίσεις του και άλλες συσκευές (όπως το μόντεμ) θα μπορέσουν να ανακαλύψουν ξανά το router και να επικοινωνήσουν μαζί του. Αυτή η διαδικασία ονομάζεται επανεκκίνηση.

Για να κάνετε επανεκκίνηση του router σας χρησιμοποιώντας το καλώδιο τροφοδοσίας, ακολουθήστε τα παρακάτω βήματα:

1. Αποσυνδέστε το καλώδιο τροφοδοσίας από το router και το μόντεμ.
2. Περιμένετε 10 δευτερόλεπτα και συνδέστε ξανά το καλώδιο τροφοδοσίας στο μόντεμ. Βεβαιωθείτε πως έχει ρεύμα.
3. Περιμένετε μέχρι η ένδειξη σύνδεσης του μόντεμ να έχει σταματήσει να αναβοσβήνει (περίπου δύο λεπτά). Συνδέστε ξανά το καλώδιο τροφοδοσίας στο router.
4. Περιμένετε έως ότου εμφανιστεί το φωτεινό λογότυπο Linksys. Περιμένετε δύο λεπτά πριν να δοκιμάσετε να συνδεθείτε στο Internet από έναν υπολογιστή.

Για να κάνετε επανεκκίνηση του router σας χρησιμοποιώντας το Linksys Smart Wi-Fi, ακολουθήστε τα παρακάτω βήματα:

1. Συνδεθείτε στο Linksys Smart Wi-Fi. (Ανατρέξτε στην ενότητα "Πώς να συνδεθείτε στο Linksys Smart Wi-Fi" στη σελίδα [11](#).)
2. Στο πεδίο *Router Settings* (Ρυθμίσεις router) κάντε κλικ στο *Troubleshooting* (Αντιμετώπιση προβλημάτων).
3. Κάντε κλικ στην καρτέλα *Diagnostics* (Διαγνωστικός έλεγχος).

4. Στην επιλογή *Reboot* (Επανεκκίνηση), κάντε κλικ στο **Reboot** (Επανεκκίνηση).



5. Κάντε κλικ στο Ναι. Θα γίνει επανεκκίνηση του router. Κατά τη διάρκεια της επανεκκίνησης του router, όλες οι συνδεδεμένες συσκευές θα χάσουν τη σύνδεση στο Internet και θα επανασυνδεθούν αυτόματα όταν το router είναι έτοιμο ξανά.

## Το Linksys Smart Wi-Fi δεν ανοίγει στο πρόγραμμα περιήγησης Web

Με το Linksys Smart Wi-Fi λειτουργούν οι τελευταίες εκδόσεις του Google Chrome™, Firefox®, Safari® (για Mac® και iPad®), Microsoft Edge και Internet Explorer® έκδοση 8 και νεότερες.

# Τεχνικά χαρακτηριστικά

## Linksys EA8300

Όνομα μοντέλου	Router Τριών Ζωνών Max-Stream AC2200 MU-MIMO
Αριθμός μοντέλου	EA8300
Ταχύτητα θύρας μεταγωγέα	10/100/1000 Mbps (Gigabit Ethernet)
Συχνότητα ασύρματου δικτύου	2,4 GHz και 5 GHz (x2)
# κεραιών	4 ρυθμιζόμενες εξωτερικές κεραιές (μη αποσπώμενες)
Θύρες	USB 3.0, Ethernet (1-4), Internet, τροφοδοσίας
Κουμπιά	Wi-Fi Protected Setup, Ενεργοποίησης/Απενεργοποίησης, Επαναφοράς
Λυχνίες	Επάνω πλαίσιο: Φωτισμένο λογότυπο Linksys , Wi-Fi Protected Setup, σύνδεσης στο Internet, σύνδεσης καλωδίου δικτύου στη θύρα Internet Πίσω πλαίσιο: USB, Ethernet (1-4), Internet
UPnP	Υποστηρίζεται
Λειτουργίες ασφαλείας	WEP, WPA2, RADIUS
Bit κλειδιού ασφαλείας	Κρυπτογράφηση έως 128-bit
Υποστήριξη συστήματος αρχείων αποθήκευσης	FAT, NTFS, και HFS+
Υποστηριζόμενα προγράμματα περιήγησης	Οι τελευταίες εκδόσεις των Google Chrome™, Firefox®, Safari® (για Mac® και iPad®), Microsoft Edge, και Internet Explorer® έκδοση 8 και νεώτερες

## Χαρακτηριστικά περιβάλλοντος λειτουργίας

Διαστάσεις	213,7mm x 161,8mm x 54,8mm (χωρίς κεραιές)
Βάρος μονάδας	608 g
Ισχύς	12V, 2A
Πιστοποιήσεις	FCC, IC, CE, Wi-Fi (a/b/g/n/ac)
Θερμοκρασία λειτουργίας	0 έως 40°C
Θερμοκρασία αποθήκευσης	-20 έως 60°C
Υγρασία λειτουργίας	10% έως 80% σχετική υγρασία, χωρίς συμπύκνωση
Υγρασία αποθήκευσης	5% έως 90% χωρίς συμπύκνωση

Οι προδιαγραφές μπορούν να αλλάξουν χωρίς προειδοποίηση.

Σημειώσεις:

Για πληροφορίες σχετικά με τους κανονισμούς, την εγγύηση και την ασφάλεια, βλ. το CD που συνόδευε το router σας ή μεταβείτε στο [Linksys.com/support/EA8300](http://Linksys.com/support/EA8300).

Η μέγιστη απόδοση προκύπτει από τις προδιαγραφές του προτύπου IEEE 802.11. Η πραγματική απόδοση ενδέχεται να διαφέρει (χαμηλότερη χωρητικότητα ασύρματου δικτύου, διεκπεραιωτική ικανότητα δεδομένων, εύρος, εμβέλεια κ.α.). Η απόδοση εξαρτάται από πολλούς παράγοντες, συνθήκες και μεταβλητές, όπου περιλαμβάνεται η απόσταση από το σημείο πρόσβασης, ο όγκος της κίνησης του δικτύου, τα υλικά κατασκευής και η ίδια η κατασκευή, το χρησιμοποιούμενο λειτουργικό σύστημα, ο συνδυασμός των χρησιμοποιούμενων ασύρματων προϊόντων, οι παρεμβολές και άλλες αντίξοες συνθήκες.

Οι επωνυμίες BELKIN, LINKSYS και πολλά ονόματα προϊόντων και λογότυπα αποτελούν εμπορικά σήματα του ομίλου εταιριών Belkin. Τυχόν εμπορικά σήματα τρίτων που αναφέρονται, αποτελούν ιδιοκτησία των αντίστοιχων κατόχων τους. Οι άδειες και οι γνωστοποιήσεις για λογισμικό τρίτων εταιριών που χρησιμοποιείται σε αυτό το προϊόν είναι διαθέσιμες στην παρακάτω διεύθυνση: <http://support.linksys.com/en-us/license>. Επικοινωνήστε με το <http://support.linksys.com/en-us/gplcodecenter> για ερωτήσεις ή σχετικά με αιτήματα πηγαίου κώδικα GPL.

© 2017 Belkin International, Inc. ή/και θυγατρικές εταιρείες. Με επιφύλαξη κάθε νόμιμου δικαιώματος.

**LINKSYS®**

Guía del usuario

**ROUTER GIGABIT  
MU-MIMO DE BANDA TRIPLE  
AC2200  
MAX-STREAM™**

Modelo EA8300

# Contenido

Descripción general del producto .....	3
Vista superior.....	3
Indicador de estado del sistema .....	4
Vista trasera.....	5
Vista lateral .....	6
Instalación: Nociones básicas .....	7
Dónde encontrar más ayuda.....	7
Cómo instalar su router.....	8
Cómo utilizar Linksys Smart Wi-Fi.....	11
Cómo conectar a Linksys Smart Wi-Fi.....	11
Mapa de red.....	12
Acceso de usuarios invitados.....	12
Controles parentales.....	13
Priorización de contenido multimedia.....	13
Prueba de velocidad .....	14
Almacenamiento externo.....	14
Conectividad .....	15
Resolución de problemas.....	15
Funciones inalámbricas.....	16
Seguridad.....	16
Resolución de problemas .....	17
El router no se configuró correctamente.....	17
Mensaje de <i>Su cable de Internet no está conectado</i> .....	18
Mensaje de <i>No se puede acceder al router</i> .....	19
Tras la instalación.....	21
Parece que Internet no está disponible .....	21
Linksys Smart Wi-Fi no se abre en su navegador web .....	22
Especificaciones .....	23
Linksys EA8300 .....	23
Características.....	23



# Descripción general del producto

## Vista superior

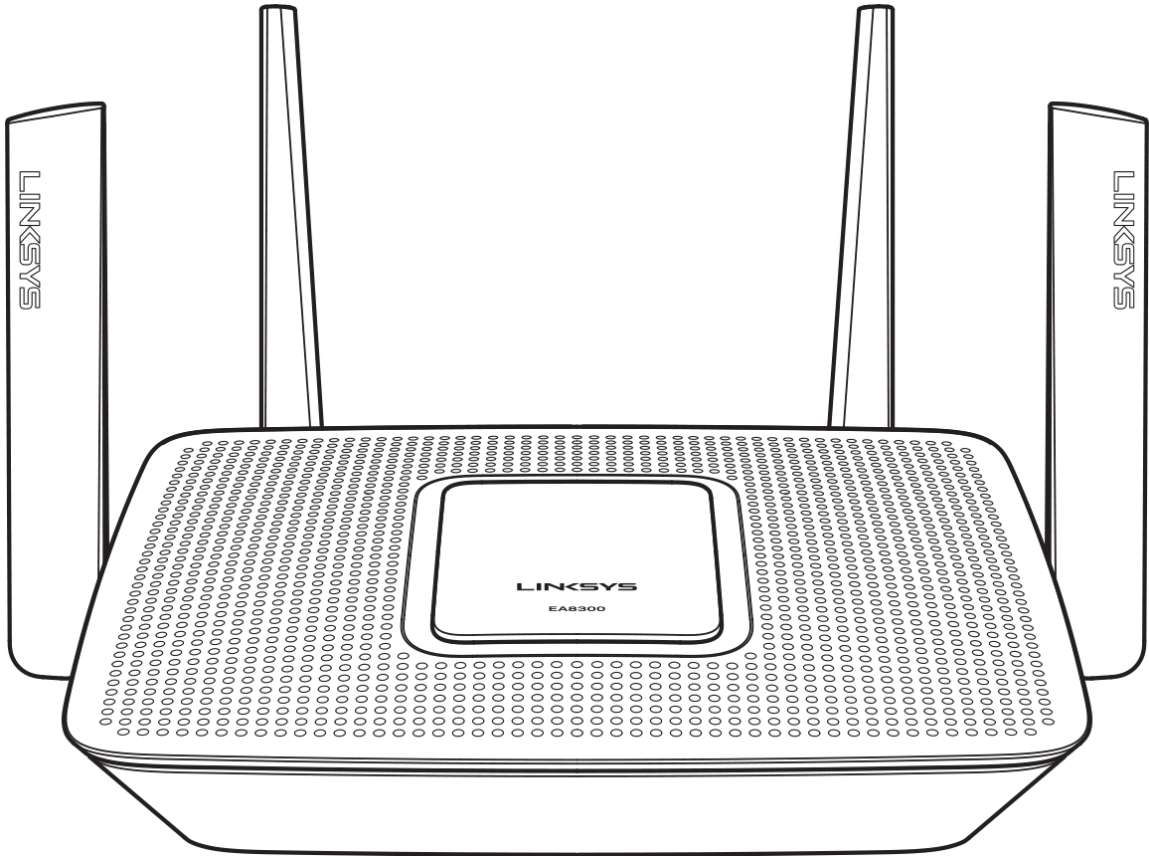

## Indicador de estado del sistema

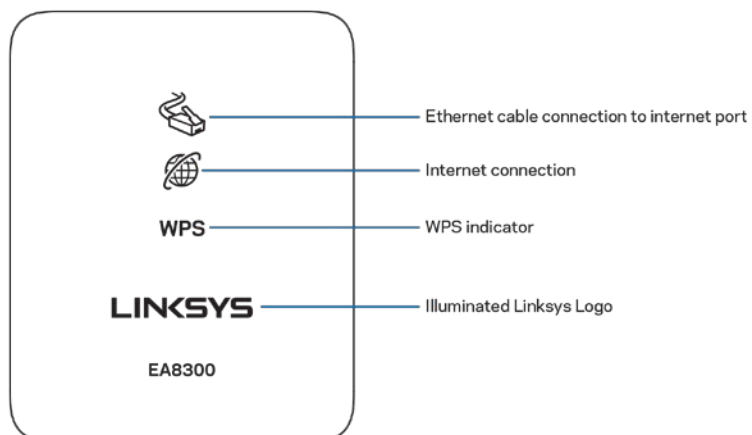

**Conexión de cable Ethernet a puerto de internet:** cuando se ilumina (naranja), indica que hay un problema con el cable de red conectado al puerto de internet (WAN).

**Conexión de internet:** cuando se ilumina (naranja), indica que el router no puede acceder a internet.

**Indicador WPS (Wi-Fi Protected Setup™):** la luz de WPS tiene cuatro estados:

<b>Apagado</b>	Sin actividad de Wi-Fi Protected Setup
<b>Blanco titilando</b>	Wi-Fi Protected Setup en progreso
<b>Blanco fijo</b>	Wi-Fi Protected Setup exitosa, se mantiene encendida por cinco segundos
<b>Naranja titilando</b>	Wi-Fi Protected Setup con error, titila por un minuto y luego se apaga

**Logotipo iluminado de Linksys:** titila mientras el router está encendiéndose. Cuando el logotipo está en blanco fijo, el router está encendido y funcionando correctamente.

## Vista trasera

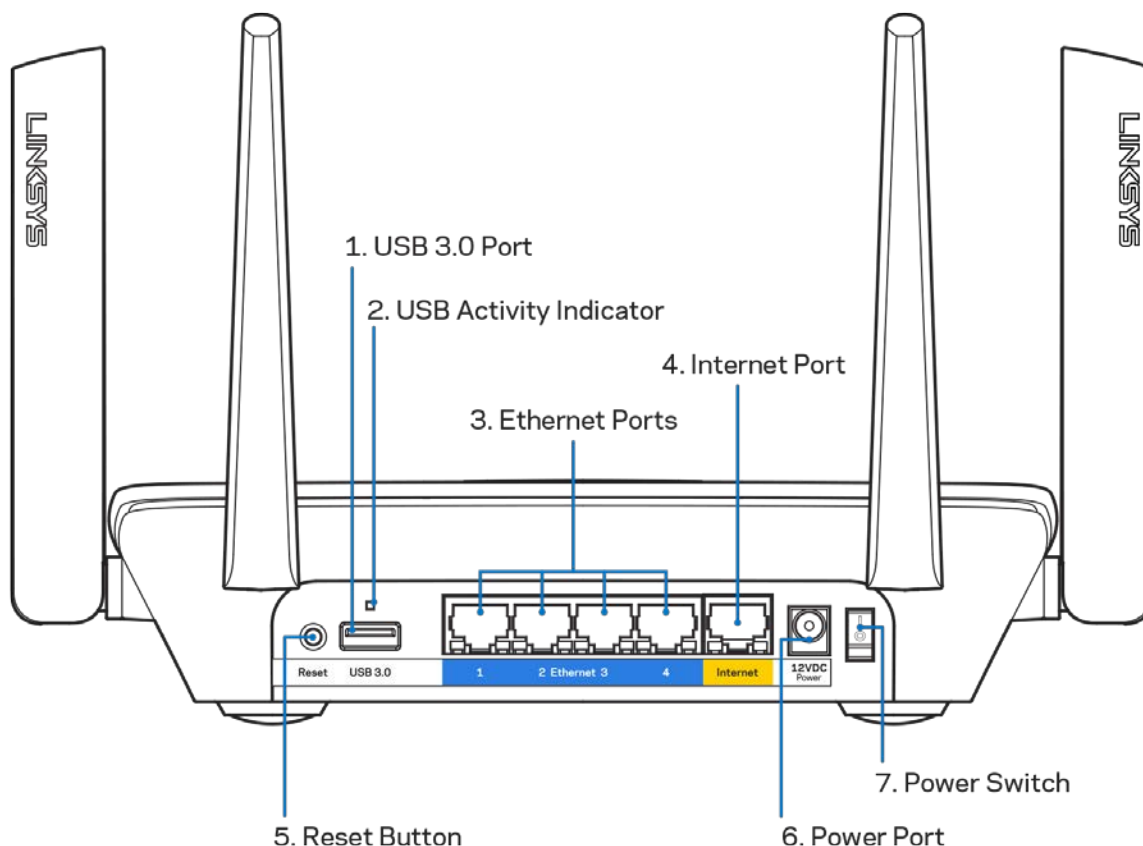

**Puerto USB 3.0 (1):** conecte y comparta unidades USB en su red o en Internet.

**Indicador de actividad USB (2):** la luz indica que hay transferencia de datos desde/hacia dispositivos externos.

**Puertos Ethernet (3):** conecte cables Ethernet a estos puertos gigabit azules (10/100/1000) y a dispositivos con cable en su red.

*Nota: para obtener el mejor desempeño use cables CAT5e o de mejor calidad en los puertos Ethernet.*

**Puerto de Internet (4):** conecte un cable Ethernet a este puerto gigabit amarillo (10/100/1000) y a un módem de Internet de banda ancha de cable/DSL o de fibra.

*Nota: para obtener el mejor desempeño, use cables CAT5e o de mejor calidad en el puerto de Internet.*

**Botón de reinicio (5):** manténgalo presionado hasta que el logotipo iluminado de Linksys se apague para restablecer la configuración de fábrica del router. También puede restablecer la configuración de fábrica usando Linksys Smart Wi-Fi en Internet o en la aplicación móvil.

**Puerto de electricidad (6):** conecte el adaptador de electricidad CA incluido.

**Interruptor de energía (7):** presione | (on) para encender el router.

## Vista lateral

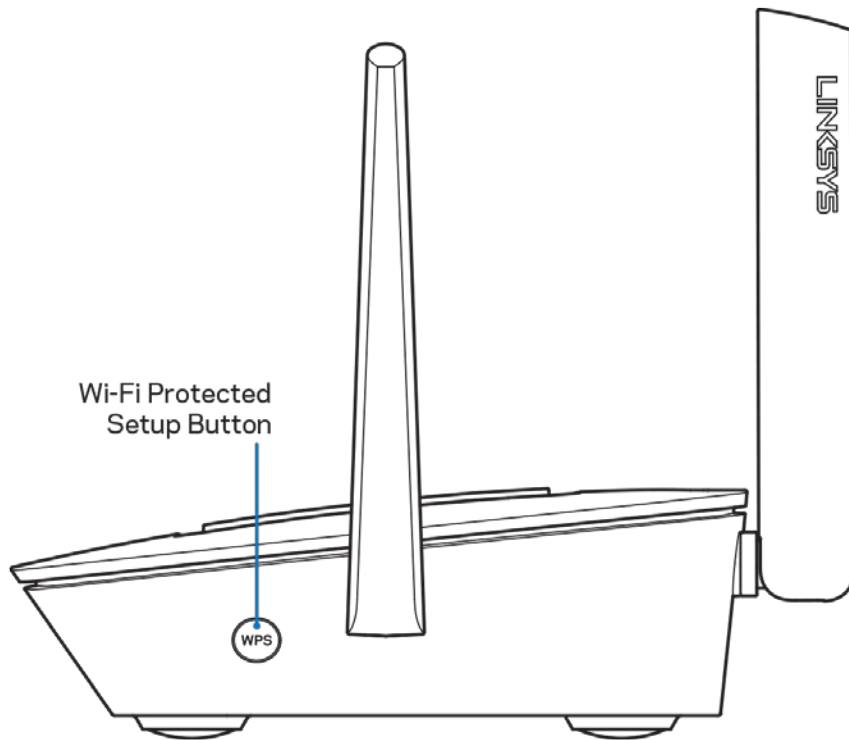

**Botón de Wi-Fi Protected Setup:** presione para conectar dispositivos de red habilitados con Wi-Fi Protected Setup.

# Instalación: Nociones básicas

## Dónde encontrar más ayuda

Además de esta guía del usuario puede obtener ayuda en:

- [Linksys.com/support/EA8300](http://Linksys.com/support/EA8300) (documentación, descargas, preguntas frecuentes, asistencia técnica, chat en vivo, foros)
- Ayuda de Linksys Smart Wi-Fi (conéctese a Linksys Smart Wi-Fi y a continuación haga clic en Ayuda en la parte superior de la pantalla)

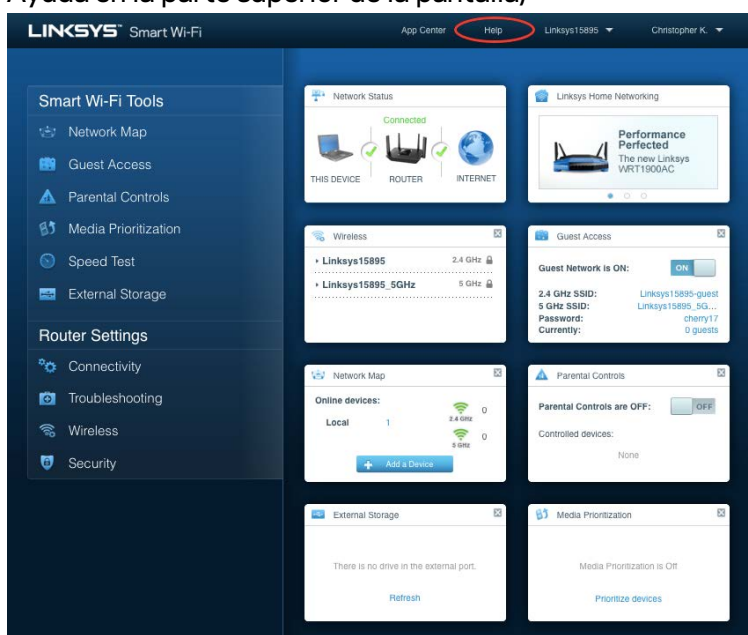

The screenshot shows the Linksys Smart Wi-Fi web interface. The top navigation bar includes 'App Center', 'Help' (highlighted with a red circle), 'Linksys15895', and 'Christopher K.'. The main dashboard displays various network status and settings widgets. A 'Help' dialog box is open, showing the 'Using Linksys Smart Wi-Fi' section and a 'Help Categories' list.

**Using Linksys Smart Wi-Fi**

Linksys Smart Wi-Fi allows you to access all of your router's features and settings. Simply click on a feature or widget you want to open.

You can use Linksys Smart Wi-Fi to:

- See what's currently connected to your network, and connect more computers and devices.
- Create a Linksys Smart Wi-Fi account to access router settings from anywhere using any browser, even when you're away from home. You can personalize your router and change settings for wireless access, Internet, gaming, local network, and more. You can even access router settings for multiple routers, which is helpful if you set up and manage more than one router. (The account is available only on EA-Series routers.)
- Allow guests in your home to use the Internet without giving them access to your network. While on the guest network, users can surf the net, but won't be able to access your printers, other computers, or devices on your network.

**Help Categories**

- Linksys Smart Wi-Fi
- Device List
- Guest Access
- Parental Controls
- Media Prioritization
- Speed Test
- External Storage
- Connectivity

Ok

**Nota:** las licencias y los avisos para los software de terceros que se usan en este producto se pueden ver en <http://support.linksys.com/en-us/license>. Comuníquese con <http://support.linksys.com/en-us/gplcodecenter> en el caso de tener preguntas o para pedir códigos fuente GPL.

## Cómo instalar su router

1. Para completar la instalación necesitará un computador para visitar el sitio <http://LinksysSmartWiFi.com> en un navegador web.
2. Identifique su equipo.

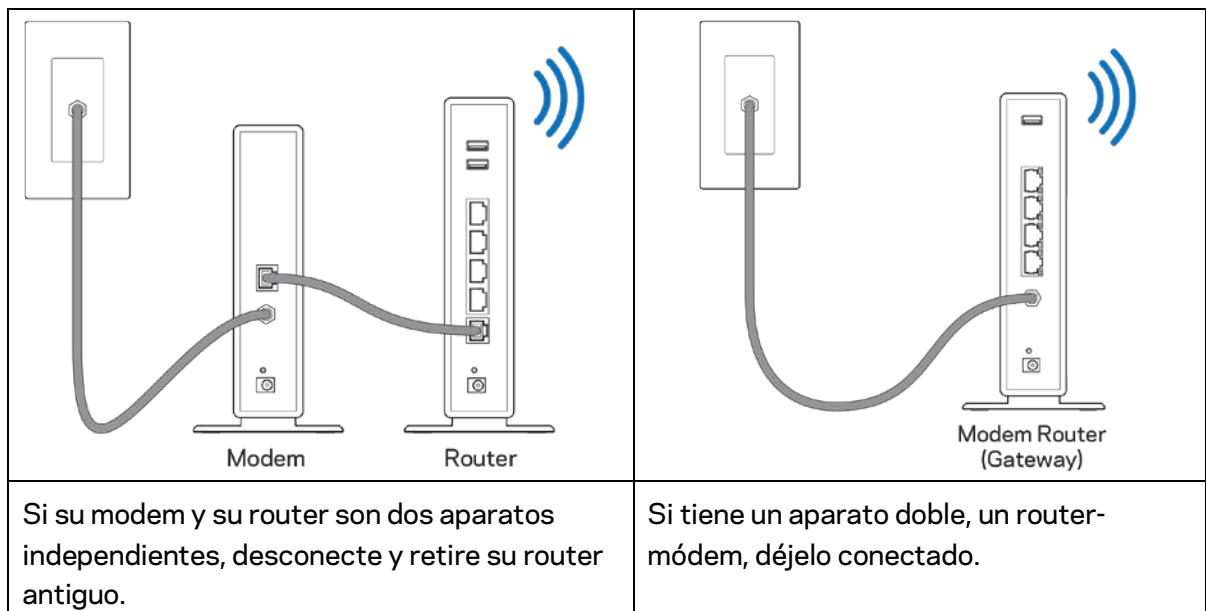

3. Posicione las antenas en posición vertical y enchufe el router a una fuente de electricidad. Asegúrese de que el interruptor de energía está en la posición | (on).
4. Conecte su router al módem o al router-módem. Conecte uno de los extremos del cable de Internet al puerto amarillo de su router nuevo. Si tiene un módem conecte el otro extremo en el puerto Ethernet (LAN) del mismo. Si tiene un router-módem conéctelo en cualquier puerto disponible.
5. Espere hasta que la luz encendida de Linksys de la parte de arriba del router deje de titilar y se encienda en blanco fijo.
6. Conecte al nombre de red Wi-Fi que se muestra en la Guía de inicio rápido incluida en su router (puede cambiar estos parámetros después). Si necesita ayuda para conectarse a la red, consulte la documentación del dispositivo en el sitio [linksys.com/support/EA8300](http://linksys.com/support/EA8300).

**Nota:** no tendrá acceso a Internet hasta que la instalación se haya completado.

7. Ingrese la dirección <http://LinksysSmartWiFi.com> en el navegador web. Siga las instrucciones en pantalla para completar la instalación del router. Puede también escribir 192.168.1.1 en un navegador web para iniciar la instalación.

Al final de la instalación siga las instrucciones en pantalla para configurar su cuenta de Linksys Smart Wi-Fi. Use Linksys Smart Wi-Fi para configurar su router desde cualquier computadora con conexión a Internet.

Gestione sus ajustes de su router:

- Cambiar el nombre y la contraseña del router
- Configurar el acceso de usuarios invitados
- Configurar el control para padres
- Conectar dispositivos a su Wi-Fi
- Probar la velocidad de su conexión a Internet

**Nota:** *durante el proceso de configuración de cuenta de Linksys Smart Wi-Fi, se le enviará un correo electrónico de verificación. Desde su red doméstica haga clic en el enlace incluido en el correo para asociar su router con la cuenta de Linksys Smart Wi-Fi.*

**Consejo:** *imprima la siguiente página y apunte los parámetros de configuración de su router y cuenta en la tabla como referencia. Guarde sus notas en un lugar seguro.*

Nombre de la red Wi-Fi de 2,4 GHz	
Contraseña de Wi-Fi	
Nombre de la red Wi-Fi de 5 GHz <sub>1</sub>	
Contraseña de Wi-Fi	
Nombre de la red Wi-Fi de 5 GHz <sub>2</sub>	
Contraseña de Wi-Fi	
Contraseña de router	
Nombre de la red Wi-Fi de 2,4 GHz para usuarios invitados	
Nombre de la red Wi-Fi de 5 GHz para usuarios invitados	
Contraseña de la red Wi-Fi para invitados (ambas redes comparten una misma contraseña).	
Nombre de usuario de Linksys Smart Wi-Fi	
Contraseña de Linksys Smart Wi-Fi	



# Cómo utilizar Linksys Smart Wi-Fi

Puede gestionar su router desde cualquier lugar del mundo usando Linksys Smart Wi-Fi pero también lo puede hacer directamente en su red doméstica. Linksys Smart Wi-Fi puede estar disponible también en su dispositivo móvil. Consulte la tienda de aplicaciones de su dispositivo para más información.

## Cómo conectar a Linksys Smart Wi-Fi

Para conectarse a Linksys Smart Wi-Fi:

1. Abra un explorador web en su computadora.
2. Vaya a <http://LinksysSmartWiFi.com> e inicie la sesión en su cuenta log.

Si no recuerda su contraseña haga clic en *¿Olvidó su contraseña?* y siga las instrucciones en pantalla.

## Mapa de red

Le permite ver y administrar todos los dispositivos de la red conectados a su router. Puede ver los dispositivos en su red principal y en su red de invitados o mostrar información sobre cada dispositivo.



## Acceso de usuarios invitados

Le permite configurar y controlar una red que los invitados puedan acceder a Wi-Fi sin exponer su información personal.

The screenshot shows the 'Guest Access' configuration page. At the top, there's a title 'Guest Access' and a checkbox 'Show widget on the homepage' which is checked. Below the title, there's a subtitle 'Guest access allows visitors to connect to your wireless guest network and access the Internet, without giving access to your other computers or personal data.' The main section is titled 'Allow guest access' and has a toggle switch set to 'ON'. To the right of this section is a warning box with an exclamation mark icon and the text: 'Your guest should first connect to your guest network, open a web browser, and then enter the guest password.' Below this, there's a section 'Guest network names and password' with an 'Edit' link. It lists: '2.4 GHz SSID: parlor2.4', 'Network: Enabled', '5 GHz SSID: parlor5', and 'Network: Enabled'. Below that, it shows 'Guest network password: thefly'. At the bottom, there's a section 'Total guests allowed' with a dropdown menu set to '5 guests'. At the bottom right, there are 'OK' and 'Cancel' buttons.

## Controles parentales

Le permiten bloquear sitios web y establecer los tiempos de acceso a Internet.

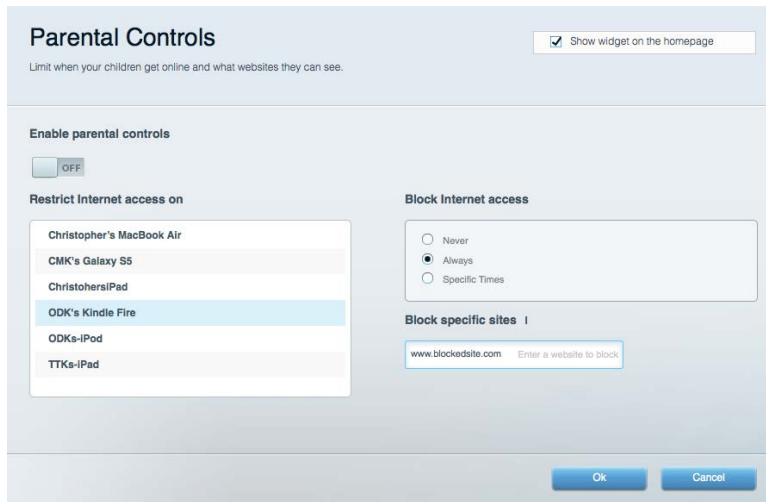

## Priorización de contenido multimedia

Le permite establecer qué dispositivos y aplicaciones tienen prioridad para el tráfico de su red.

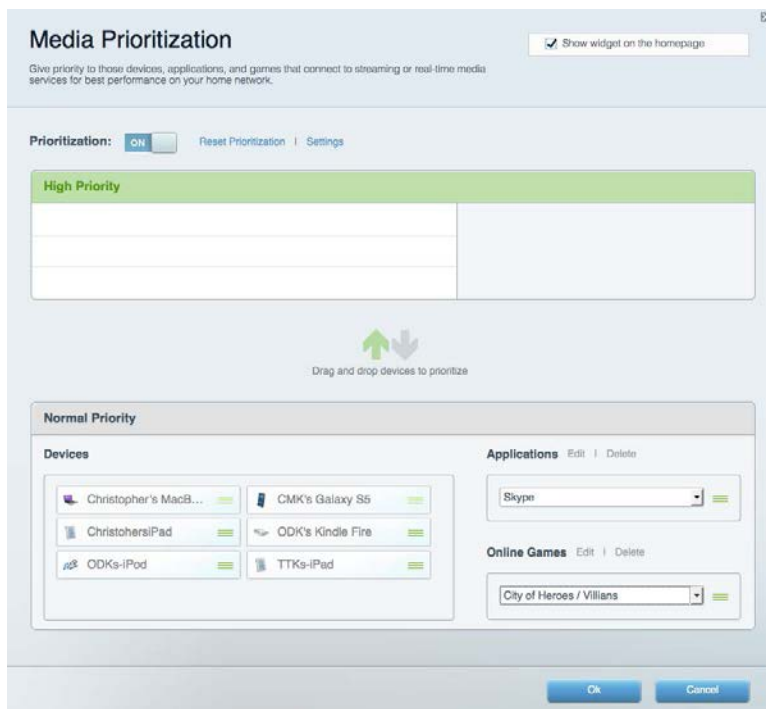

## Prueba de velocidad

Le permite probar la velocidad de conexión a Internet de su red.



## Almacenamiento externo

Le permite acceder a una unidad USB conectada (no incluida) y configurar la función de compartir archivos, un servidor de medios y acceso a un FTP.



# Conectividad

Le permite visualizar y cambiar los ajustes de red básicos y avanzados.

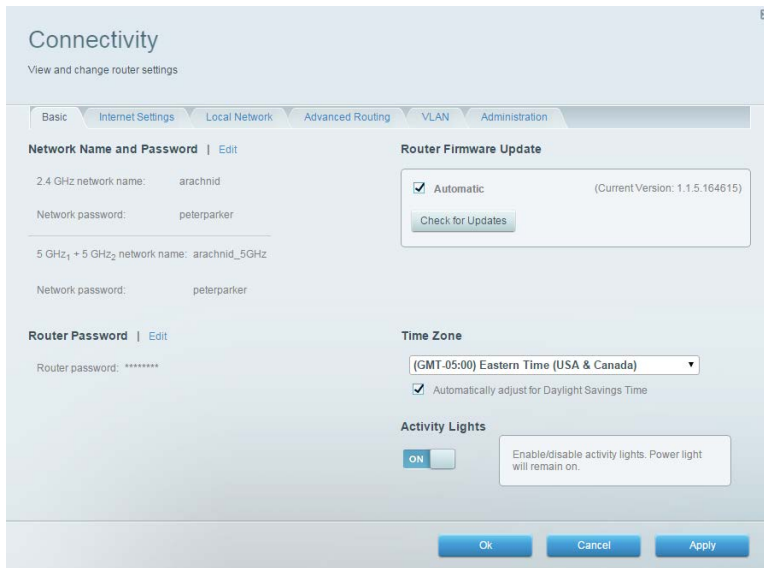

# Resolución de problemas

Le permite diagnosticar los problemas de su router y controlar el estado de su red.

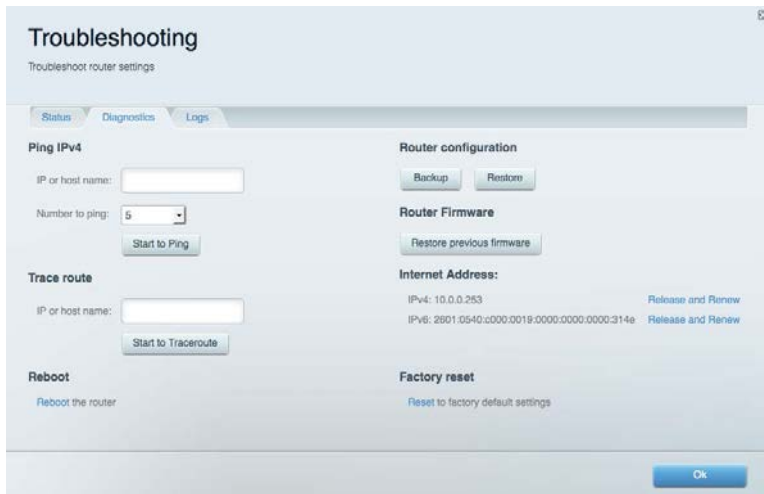

## Funciones inalámbricas

Le permite visualizar y cambiar la red inalámbrica de su router. Puede cambiar los nombres de red, el modo de seguridad, la contraseña, el filtrado MAC y conectar dispositivos usando el Wi-Fi Protected Setup.

The screenshot shows the 'Wireless' settings page. At the top, there is a 'Show widget on the homepage' checkbox which is checked. Below this, there are tabs for 'Wireless', 'MAC Filtering', and 'Wi-Fi Protected Setup'. The 'Smart Connect' section has two radio buttons: '5 GHz band steering' (selected) and 'Off'. Below this, there are two network configuration sections. The first is for the 2.4 GHz network, with the name 'arachnid', password 'peterparker', and security mode 'WPA2/WPA Mixed P'. The second is for the 5 GHz network, with the name 'arachnid\_5GHz', password 'peterparker', and security mode 'WPA2/WPA Mixed P'. At the bottom, there are 'Ok', 'Cancel', and 'Apply' buttons.

## Seguridad

Le permite visualizar y cambiar la seguridad inalámbrica de su router. Puede establecer el firewall y los ajustes de VPN y crear configuraciones personalizadas para aplicaciones y juegos.

The screenshot shows the 'Security' settings page. It has tabs for 'Firewall', 'DMZ', and 'Apps and Gaming'. The 'Firewall' section is active and shows 'IPv4 SPI firewall protection' and 'IPv6 SPI firewall protection' both enabled. There is also a 'VPN Passthrough' section with 'IPSec Passthrough', 'PPTP Passthrough', and 'L2TP Passthrough' all enabled. The 'Internet filters' section has 'Filter anonymous Internet requests' and 'Filter ident (Port 113)' checked. At the bottom, there is a table for 'IPv6 Port Services' with columns for Description, Protocol, IPv6 Address, Allow, and Enabled. Below the table is an 'Add IPv6 Firewall Setting' button. At the bottom of the page, there are 'Ok', 'Cancel', and 'Apply' buttons.

# Resolución de problemas

Puede encontrar más ayuda de nuestro premiado servicio de atención al cliente en [Linksys.com/support/EA8300](https://Linksys.com/support/EA8300).

## El router no se configuró correctamente

Si Linksys Smart Wi-Fi no completó el proceso de instalación puede intentar lo siguiente:

- Presione y mantenga el botón de reinicio en su router con un clip de papel o alfiler hasta que el logotipo iluminado de Linksys se apague y los indicadores MU-MIMO azules comiencen a titilar (unos 10 segundos). Instale el router de nuevo.

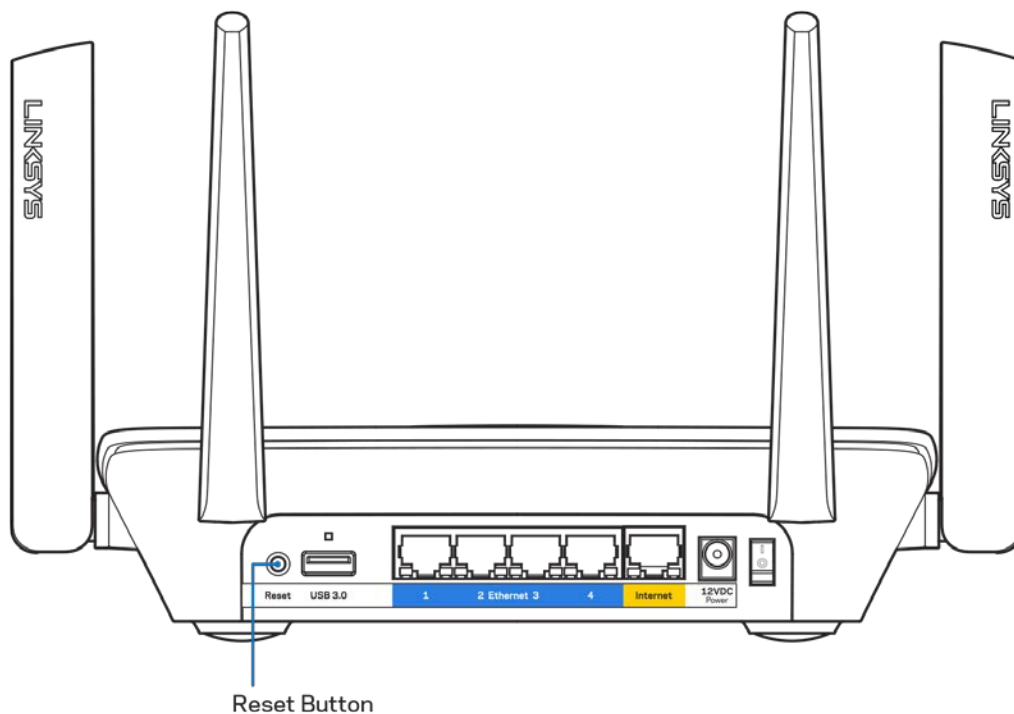

- Deshabilite temporalmente el firewall de su computadora (consulte las instrucciones del software de seguridad para obtener ayuda). Instale el router de nuevo.
- Si tiene otra computadora úsela para instalar el router de nuevo.

## Mensaje de *Su cable de Internet no está conectado*

Si cuando intenta instalar el router recibe el siguiente mensaje "Su cable de Internet no está conectado", siga los siguientes pasos de resolución de problemas.

- Asegúrese de que un cable de Ethernet o de Internet (o un cable como el que se suministra con el router) esté conectado firmemente al puerto amarillo de Internet en la parte posterior del router y en el puerto adecuado de su módem. Este puerto suele etiquetarse en el módem como Ethernet.

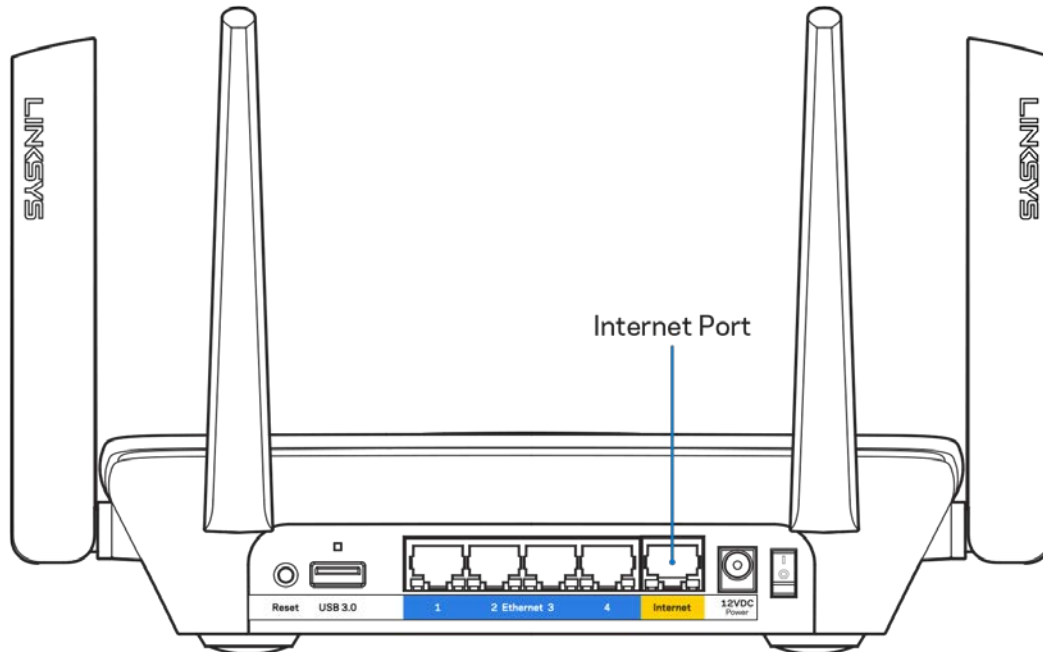

- Asegúrese de que su módem esté conectado a una fuente de energía y encendido. Si tiene un interruptor de encendido asegúrese de que está fijado en la posición ON o | (opuesto a O).

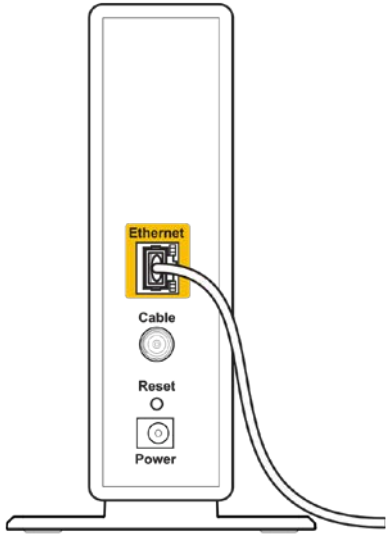
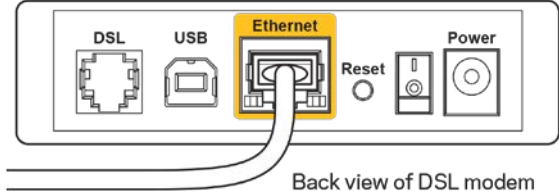

 <p>Back view of cable modem</p>	 <p>Back view of DSL modem</p>
<p>Si su servicio de Internet es cable verifique que en el puerto de CABLE del módem-cable está conectado el cable coaxial que su ISP le ha suministrado.</p>	<p>Si su servicio de Internet es DSL asegúrese de que la línea de teléfono DSL está conectados al puerto DSL del módem.</p>

- Si su computadora estaba conectada al módem con un cable USB, desconecte el cable USB.
- Instale el router de nuevo.

## Mensaje de *No se puede acceder al router*

Para acceder a su router debe estar conectado a su propia red. Si posee un acceso a Internet inalámbrico el problema puede ser que se haya conectado accidentalmente a una red inalámbrica distinta.

Para resolver el problema en computadoras Windows haga lo siguiente\*:

1. Haga clic en el icono de red inalámbrica de la bandeja del sistema. Aparece una lista con las redes disponibles.

- Haga clic en su propio nombre de red Haga clic en Conectar. En el ejemplo que se encuentra a continuación, la computadora se conectó a otra red inalámbrica llamada wraith\_5GHz. El nombre de red inalámbrica del router Linksys EA8300 en este ejemplo, Damaged\_Beez2.4, se mostrará como seleccionado.



- Si se le requiere que ingrese una clave de seguridad de red digite su contraseña (clave de red) en el campo de *clave de seguridad*. Haga clic en **Aceptar**.
- Su computadora se conectará a la red y usted debería poder acceder ahora al router.

*\*Dependiendo de su versión de Windows podrían existir algunas diferencias en el texto o los iconos de estos pasos.*

Para resolver el problema en computadoras Mac haga lo siguiente:

- En la barra menú que atraviesa la parte superior de la pantalla haga clic sobre el icono de Wi-Fi. Aparecerá una lista de redes inalámbricas.
- En el ejemplo que se encuentra a continuación, la computadora se conectó a otra red inalámbrica llamada wraith\_5GHz. El nombre de red inalámbrica del router Linksys EA8300 en este ejemplo, Damaged\_Beez2.4, se mostrará como seleccionado.

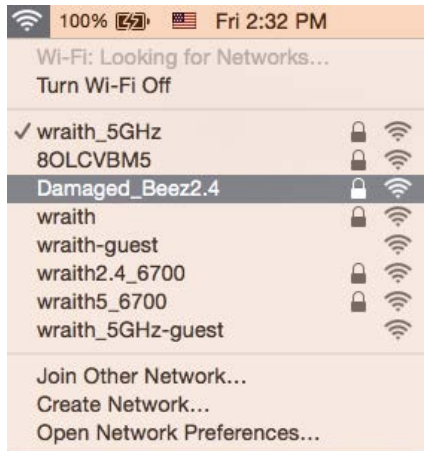

3. Haga clic en el nombre de la red inalámbrica de su router Linksys EA8300 (Damaged\_Beez2.4 en este ejemplo).
4. Digite la contraseña de su red inalámbrica (Clave de seguridad) en el campo *Contraseña*. Haga clic en **Aceptar**.

## Tras la instalación

### Parece que Internet no está disponible

Si Internet tiene dificultades para comunicarse con su router el problema puede traducirse en un mensaje "No se puede encontrar [dirección de Internet]" en su navegador web. Si tiene la certeza de que la dirección de Internet es correcta y ha intentado ya diversas direcciones de Internet válidas obteniendo el mismo resultado este mensaje podría indicar que hay un problema con su ISP o con la comunicación entre el módem y el router. Intente lo siguiente:

- Asegúrese de que los cables de red y de corriente están bien conectados.
- Asegúrese de que la toma de alimentación a la que el router está conectado tiene electricidad.
- Reinicie su router.
- Póngase en contacto con su ISP y pregúnteles si hay problemas de corte del suministro en su área.

El método más común de solucionar problemas con su router es apagarlo y volverlo a encender. Su router podrá entonces volver a cargar sus ajustes personalizados y otros dispositivos (como el módem) tendrán la oportunidad de redescubrir al router y comunicarse de nuevo con él. Este proceso se llama reinicio.

Para reiniciar su router usando el cable de energía haga lo siguiente:

1. Desconecte el cable de energía del router y del módem.
2. Espere 10 segundos y vuelva a conectar el cable de energía a su módem. Asegúrese de que tiene electricidad.
3. Espere unos dos minutos o hasta que el indicador en línea del módem haya parado de parpadear. Vuelva a conectar el cable de energía al router.

4. Espere hasta que el logotipo iluminado de Linksys se encienda. Espere dos minutos antes de intentar de nuevo la conexión a internet desde una computadora.

Para reiniciar su router usando la Linksys Smart Wi-Fi haga lo siguiente:

1. Inicie la sesión en Linksys Smart Wi-Fi (Consulte "Cómo conectar a Linksys Smart Wi-Fi" en la página [11](#)).
2. Bajo *Ajustes del router* haga clic en *Resolución de problemas*.
3. Haga clic en la ficha de *Diagnósticos*.
4. *Bajo Reiniciar* haga clic en *Reiniciar*.



5. Haga clic en **Sí**. El router se reiniciará. Mientras que el router se reinicia todos los dispositivos conectados perderán su conexión a Internet y se volverán a conectar automáticamente cuando el router esté listo de nuevo.

## Linksys Smart Wi-Fi no es abre en su navegador web

Las últimas versiones de Google Chrome™, Firefox®, Safari® (para Mac® y iPad®), Microsoft Edge y la versión 8 u otra superior de Internet Explorer® funcionan con Linksys Smart Wi-Fi.

# Especificaciones

## Linksys EA8300

Nombre de modelo	Router Gigabit MU-MIMO de banda triple AC2200 Max-Stream de Linksys
Número de modelo	EA8300
Velocidad del puerto del conmutador	10/100/1000 Mbps (Ethernet Gigabit)
Frecuencia de radio	2,4 GHz y 5 GHz (2)
Cantidad de antenas	4 antenas ajustables externas (no desmontables)
Puertos	USB 3.0, Ethernet (1-4), Internet, Energía
Botones	Wi-Fi Protected Setup, Energía, Reinicio
Luces	<b>Panel superior:</b> Logotipo de Linksys iluminado , Wi-Fi Protected Setup, conexión a Internet, Network Conexión de cable de red a puerto de internet <b>Panel trasero:</b> USB, Ethernet (1-4), Internet
UPnP	Compatible
Funciones de seguridad	WEP, WPA2, RADIUS
Bits de clave de seguridad	Cifrado de hasta 128 bits
Compatibilidad con sistemas de almacenamiento de archivos	FAT, NTFS, y HFS+
Compatibilidad de navegador	Las últimas versiones de Google Chrome™, Firefox®, Safari® (para Mac® y iPad®), Microsoft Edge y la versión 8 u otra superior de Internet Explorer®

## Características

Dimensiones	213,7mm x 161,8mm x 54,8mm (sin antenas)
Peso de la unidad	608 g
Potencia	12 V, 2A
Certificaciones	FCC, IC, CE, Wi-Fi (a/b/g/n/ac)
Temperatura de funcionamiento	De 0 a 40 °C
Temperatura de almacenaje	Entre -20 y 60 °C
Humedad de funcionamiento	Entre 10 a 80 % de humedad relativa sin condensación
Humedad de almacenamiento	De 5 a 90 % sin condensación

Las presentes especificaciones están sujetas a modificaciones sin previo aviso.

Notas:

Para obtener información sobre las regulaciones, la garantía y la información de seguridad, consulte el CD que viene con su router o visite [Linksys.com/support/EA8300](http://Linksys.com/support/EA8300).

Máximo rendimiento de conformidad con las especificaciones IEEE Standard 802.11. El rendimiento real de la capacidad de la red inalámbrica, la velocidad de los datos, el alcance y el área de cobertura pueden variar. El desempeño depende de muchos factores, condiciones y variables, tales como la distancia desde el punto de acceso, el volumen del tráfico de red, la construcción y sus materiales, el sistema operativo utilizado, la combinación de productos inalámbricos, las interferencias y otras condiciones adversas.

BELKIN, LINKSYS y muchos otros nombres de productos y logotipos son marcas registradas del grupo de compañías de Belkin. Las marcas registradas de terceros mencionadas son propiedad de sus respectivos propietarios. Las licencias y los avisos para los software de terceros que se usan en este producto se pueden ver en: <http://support.linksys.com/en-us/license>. Comuníquese con <http://support.linksys.com/en-us/gplcodecenter> para preguntas o solicitudes de código fuente GPL.

© 2017 Belkin International, Inc. y/o sus afiliadas. Todos los derechos reservados.

**LINKSYS®**

Kasutusjuhend

**MAX-STREAM™  
AC2200 MU-MIMO  
KOLMERIBALINE RUUTER**

Mudel EA8300

# Sisukord

<b>Toote ülevaade .....</b>	<b>3</b>
Pealtvaade .....	3
Süsteemi olekuindikaator.....	4
Tagantvaade.....	5
Kõrvaltvaade.....	6
<b>Seadistamine: põhitõed.....</b>	<b>7</b>
Kust leida lisaabi?.....	7
Kuidas installida ruuterit? .....	8
<b>Kuidas kasutada Linksys Smart Wi-Fi .....</b>	<b>11</b>
Kuidas ühendada Linksys Smart Wi-Fi.....	11
Võrgukaart.....	12
Külalise juurdepääs.....	12
Vanemlik järelevalve.....	13
Meedia prioritseerimine .....	13
Kiirustest .....	14
Välismälu .....	14
Ühenduvus .....	15
Tõrkeotsing.....	15
Juhtmeta ühendus.....	16
Turvalisus.....	16
<b>Tõrkeotsing .....</b>	<b>17</b>
Teie ruuteri seadistamine ebaõnnestus .....	17
Teade <i>Your Internet cable is not plugged in</i> (teie internetikaabel ei ole ühendatud) .....	18
Teade <i>Cannot access your router</i> (puudub juurdepääs ruuterile).....	19
Pärast seadistamist.....	21
Internetiga ei ole võimalik ühendust luua.....	21
Linksys Smart Wi-Fi ei avane veebilehitsejas.....	22
<b>Tehnilised andmed.....</b>	<b>23</b>
Linksys EA8300 .....	23
Keskkondlik.....	23



# Toote ülevaade

## Pealtvaade

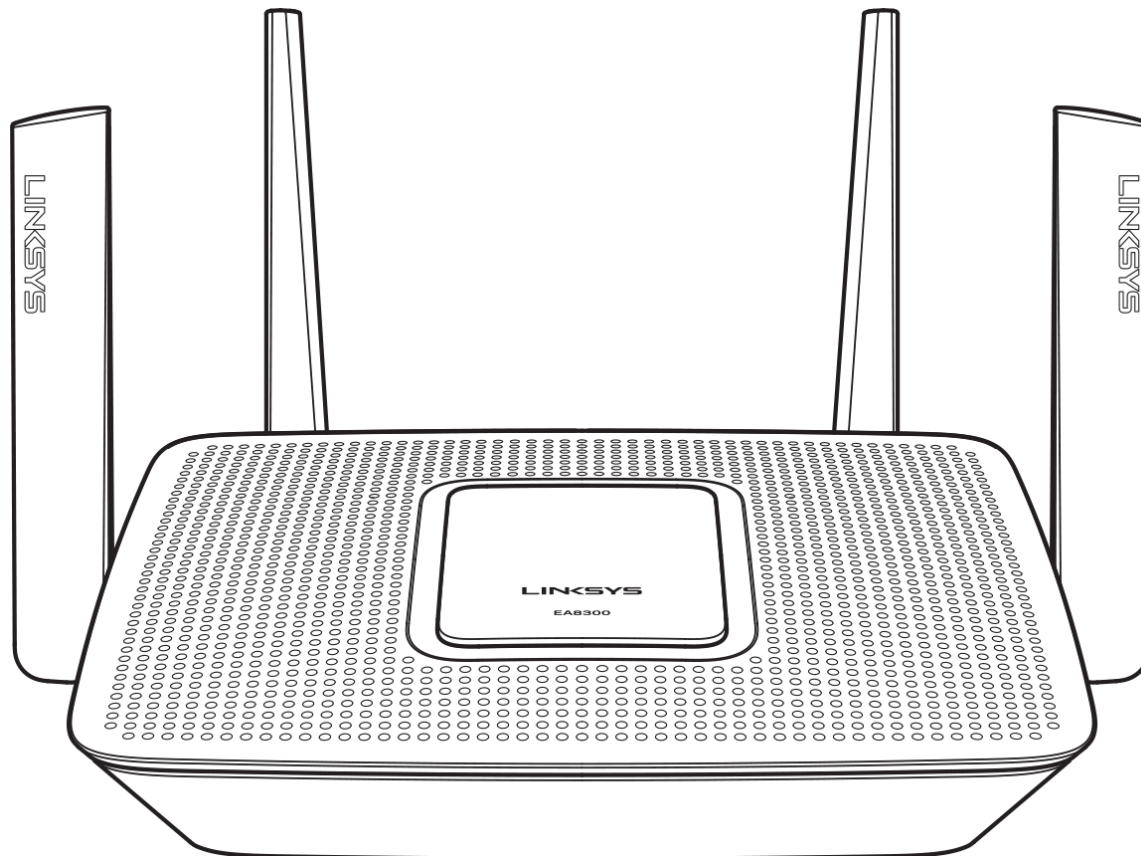

## Süsteemi olekuindikaator

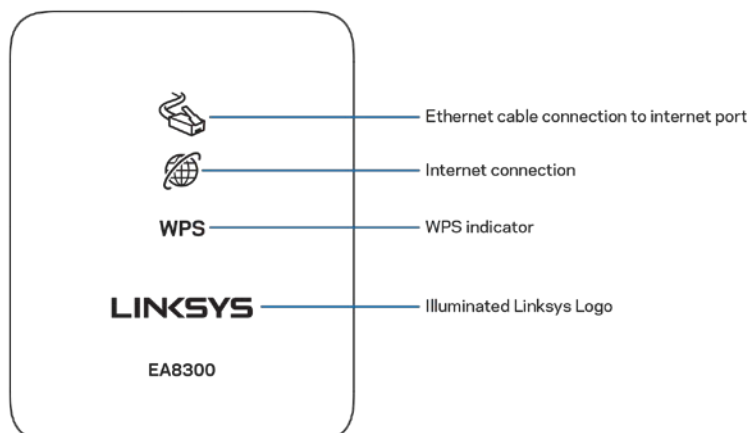

Etherneti kaabli ühendus internetipordiga – kui põleb (oranžilt), tähendab see, et internetipordiga (WAN) ühendatud võrgukaabliga on probleem.

**Internetiühendus** – kui põleb (oranžilt), tähendab see, et ruuter ei saa ligipääsu internetile.

**WPS-i (Wi-Fi Protected Setup™) indikaator** – WPS-i tulel on neli olekut.

<b>Väljas</b>	Wi-Fi Protected Setup ei tööta
<b>Vilkuv valge</b>	Wi-Fi Protected Setupi häälestamine käib parajasti
<b>Põleb valgelt</b>	Wi-Fi Protected Setupi häälestamine õnnestus; jääb põlema viieks sekundiks
<b>Vilgub oranžilt</b>	Wi-Fi Protected Setupi viga; vilgub ühe minuti, seejärel kustub

**Valgustatud Linksysse logo** – logo vilgub, kui ruuter käivitub. Kui logo põleb püsivalt valgelt, on ruuter sisse lülitatud ja töötab õigesti.

## Tagantvaade

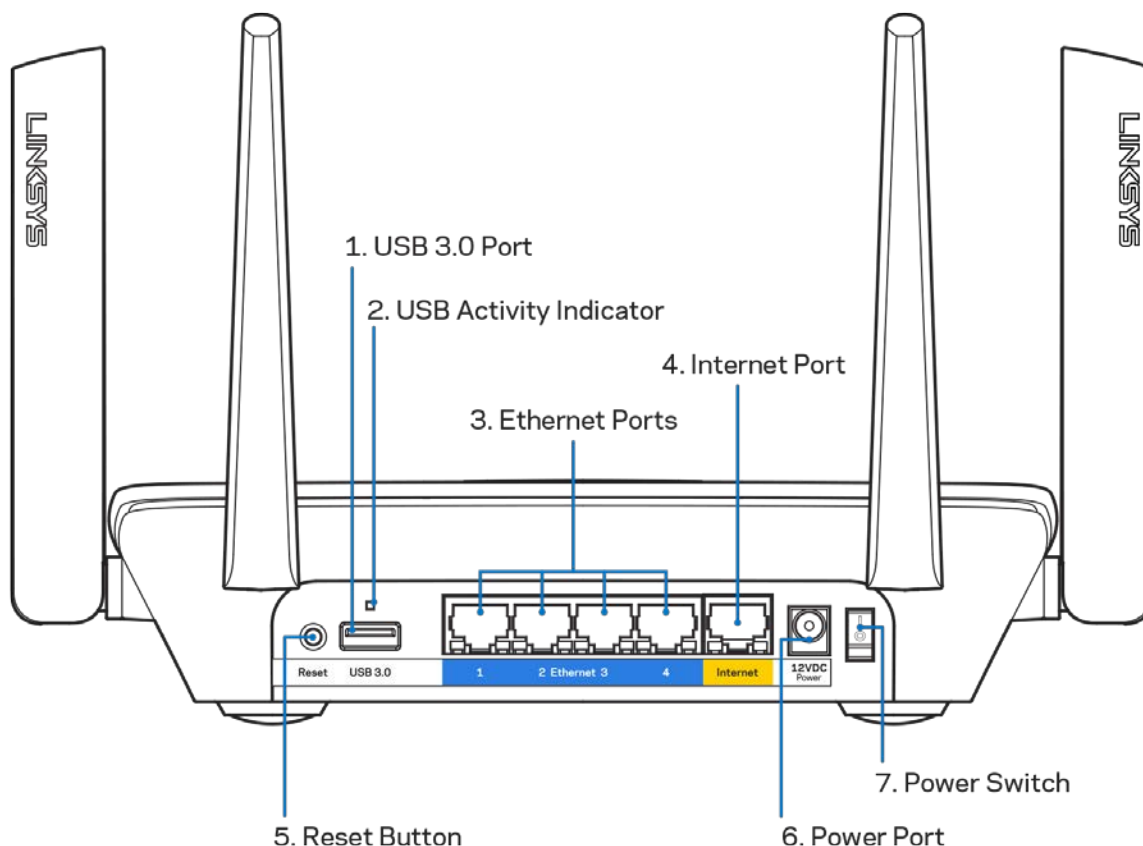

**USB 3.0 port (1)** - ühendage USB-ajamid ja jagage neid oma võrgus või internetis.

**USB aktiivsuse näidik (2)** - tuled näitavad andmete edastamist välisesse seadmesse / välisest seadmest.

**Etherneti pordid (3)** - ühendage etherneti kaablid nende siniste gigabiti (10/100/1000) portide ja teie võrgus olevate juhtmega seadmetega.

*Märkus - parima tulemuse saavutamiseks kasutage Etherneti portide ühendamiseks CAT5e või suurema kiirusega kaableid.*

**Internetipord (4)** - ühendage etherneti kaabel selle kollase gigabiti (10/100/1000) pordi ja lairibavõrgu kaabliga / DSL-iga või valguskaablimodemiga.

*Märkus - parima tulemuse saavutamiseks kasutage internetipordi ühendamiseks CAT5e või suurema kiirusega kaablit.*

**Lähtestamisnupp (5)** - vajutage ja hoidke all, kuni valgustatud Linksys logo kustub, et lähtestada ruuteri tehaseseaded. Võite tehaseseaded taastada ka Linksys Smart Wi-Fi kaudu internetis või mobiilirakenduse abil.

**Toiteport (6)** - ühendage kaasasolev vahelduvvooluadapter.

**Toitelüliti (7)** - vajutage | (sees), et ruuter sisse lülitada.

## Kõrvaltvaade

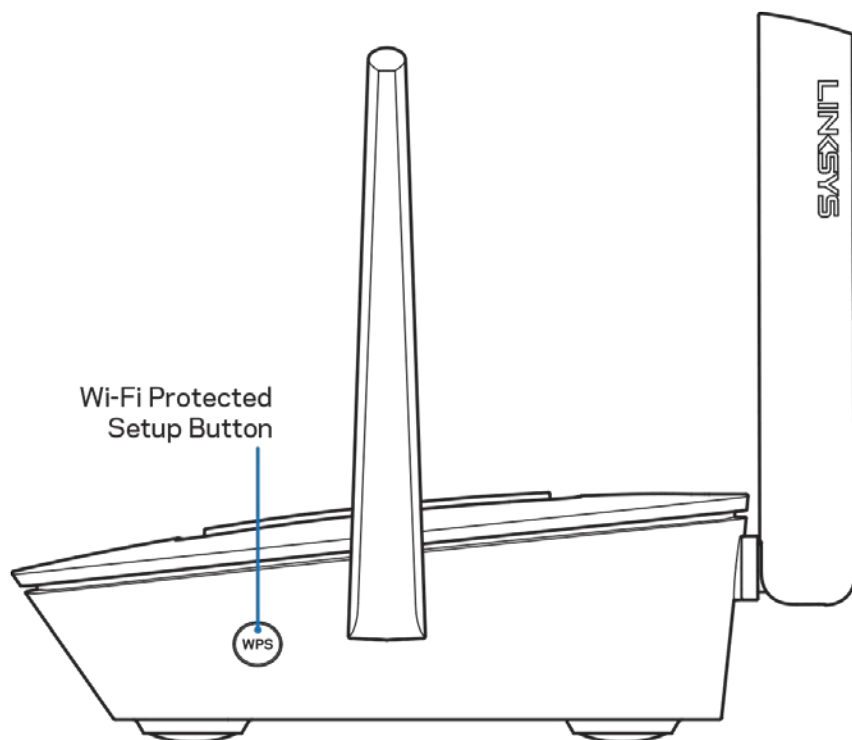

**Wi-Fi Protected Setup™-i nupp** - vajutage, et luua ühendus võrguseadmetes, kus on WPS lubatud.

# Seadistamine: põhitõed

## Kust leida lisaabi?

Lisaks kasutusjuhendile on võimalik abi saada järgmistest asukohtadest:

- [Linksys.com/support/EA8300](http://Linksys.com/support/EA8300) (dokumentatsioon, allalaadimised, KKK, tehniline abi, reaalajas vestlused, foorumid)
- Linksys Smart Wi-Fi abi (looge ühendus Linksys Smart Wi-Figa, siis klõpsake ekraani üleosas Help (abi))

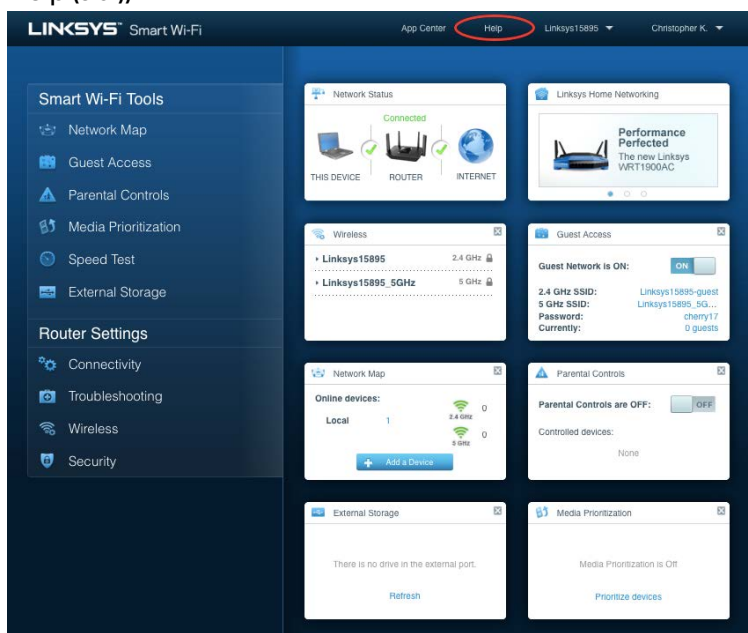

The screenshot shows the Linksys Smart Wi-Fi web interface. The top navigation bar includes 'App Center', 'Help' (highlighted with a red circle), 'Linksys15895', and 'Christopher K.'. The main content area is divided into several sections: 'Smart Wi-Fi Tools' (Network Map, Guest Access, Parental Controls, Media Prioritization, Speed Test, External Storage), 'Router Settings' (Connectivity, Troubleshooting, Wireless, Security), 'Network Status' (Connected), 'Linksys Home Networking' (Performance Perfected), 'Wireless' (Linksys15895 2.4 GHz, Linksys15895\_5GHz 5 GHz), 'Guest Access' (Guest Network is ON), 'Network Map' (Online devices: Local 1), 'Parental Controls' (Parental Controls are OFF), 'External Storage' (There is no drive in the external port), and 'Media Prioritization' (Media Prioritization is Off).

### Help

#### Using Linksys Smart Wi-Fi

Linksys Smart Wi-Fi allows you to access all of your router's features and settings. Simply click on a feature or widget you want to open.

You can use Linksys Smart Wi-Fi to:

- See what's currently connected to your network, and connect more computers and devices.
- Create a Linksys Smart Wi-Fi account to access router settings from anywhere using any browser, even when you're away from home. You can personalize your router and change settings for wireless access, Internet, gaming, local network, and more. You can even access router settings for multiple routers, which is helpful if you set up and manage more than one router. (The account is available only on EA-Series routers.)
- Allow guests in your home to use the Internet without giving them access to your network. While on the guest network, users can surf the net, but won't be able to access your printers, other computers, or devices on your network.

#### Help Categories

- Linksys Smart Wi-Fi
- Device List
- Guest Access
- Parental Controls
- Media Prioritization
- Speed Test
- External Storage
- Connectivity

Ok

**Märkus** - kolmanda osapoole tarkvara litsentse ja teatise, mida selles tootes kasutatakse, saate vaadata veebilehelt <http://support.linksys.com/en-us/license>. Võtke ühendust aadressil <http://support.linksys.com/en-us/gplcodecenter>, kui teil on küsimusi või soovite GNU avaliku litsentsi lähtekoodi.

## Kuidas installida ruuterit?

1. Häälendamiseks on teil vaja arvutit ja peate külastama veebibrauseris lehte <http://LinksysSmartWiFi.com>.
2. Tuvastage oma seade.

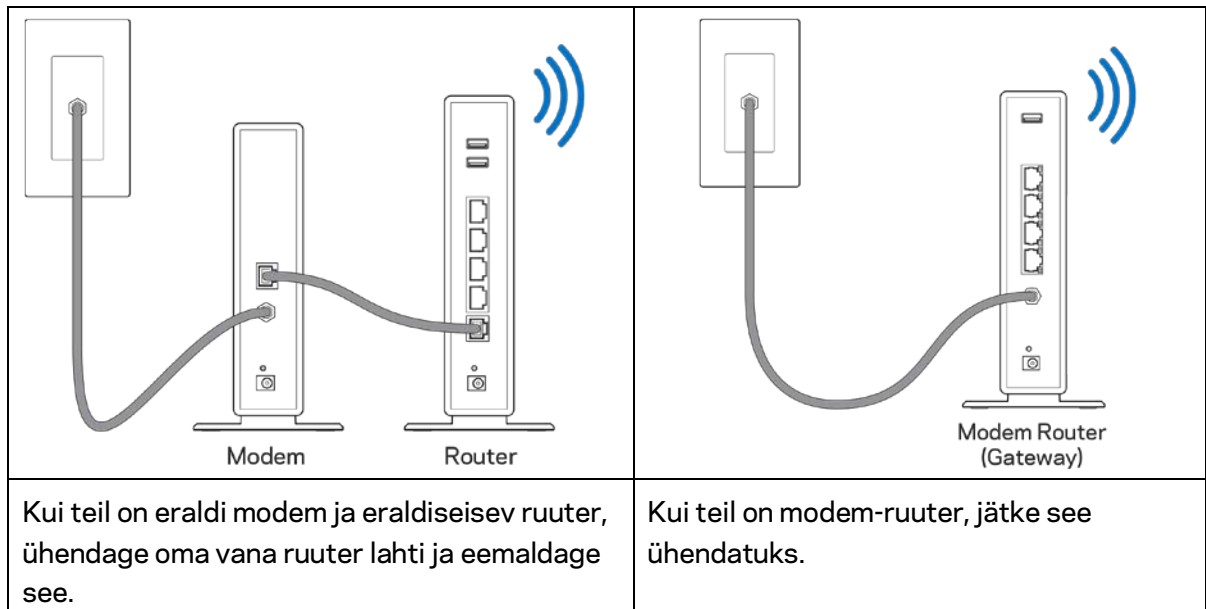

3. Paigutage antennid otse üles ja ühendage ruuter toiteallikaga. Veenduge, et toitelüliti on asendis | (sees).
4. Ühendage oma ruuter modemiga või modem ruuteriga. Ühendage üks kaasasoleva internetikaabli ots oma uue ruuteri kollase internetipordiga. Kui teil on modem, ühendage teine ots modemi Etherneti (LAN) porti. Kui teil on modem-ruuter, ühendage mis tahes saadaolevasse porti.
5. Oodake, kuni ruuteri peal olev valgustatud Linksysy tuli lõpetab vilkumise ja põleb püsivalt valgelt.
6. Ühendage Wi-Fi võrguga, mille nimi on näidatud ruuteriga kaasasolevas kiirjuhendis. (Saate neid andmeid hiljem muuta.) Kui vajate võrguga ühendamisel abi, vaadake läbi oma seadme dokumentatsioon, mille leiate aadressilt [linksys.com/support/EA8300](http://linksys.com/support/EA8300).

**Märkus** - teil ei ole internetile juurdepääsu enne, kui ruuter on häälestatud.

7. Sisestage veebibrauserisse <http://LinksysSmartWiFi.com>. Järgige ekraanil kuvatud juhiseid, et viia oma ruuteri ülesseadmine lõpuni. Samuti võite häälestamise alustamiseks trükkida brauserisse 192.168.1.1.

Häälestamise lõpus järgige ekraanile ilmuvaid juhiseid, et häälestada oma Linksys Smart Wi-Fi konto. Kasutage Linksys Smart Wi-Fi-t, et konfigurereida oma ruuter mis tahes internetiühendusega arvutist.

Ruuteri sätete haldamine

- Muuta ruuteri nime ja salasõna
- Seadistada külalise juurdepääs
- Konfigureerida vanemliku järelevalve seaded
- Ühendada oma Wi-Fi-võrguga muid seadmeid
- Testida internetiühenduse kiirust

**Märkus** - osana Linksys Smart Wi-Fi konto häälestamisest saadetakse teile e-kiri kinnitusega. Klõpsake oma koduvõrgus e-kirjas oleval lingil, et siduda oma ruuter Linksys Smart Wi-Fi kontoga.

**Näpunäide** - printige järgmine lehekülg välja, seejärel kirjutage oma ruuteri ja konto sätted nende meeles pidamiseks tabelisse. Hoidke oma märkmeid ohutus kohas.

2,4 GHz Wi-Fi nimetus	
Wi-Fi parool	
5 GHz <sub>1</sub> Wi-Fi nimetus	
Wi-Fi parool	
5 GHz <sub>2</sub> Wi-Fi nimetus	
Wi-Fi parool	
Ruuteri parool	
2,4 GHz Wi-Fi külalisvõrgu nimetus	
5 GHz Wi-Fi külalisvõrgu nimetus	
Wi-Fi külalisvõrgu parool (Mõlemad jagavad parooli.)	
Linksys Smart Wi-Fi kasutajanimi	
Linksys Smart Wi-Fi parool	



# Kuidas kasutada Linksys Smart Wi-Fi

Ruuterit on võimalik Linksys Smart Wi-Fi abil ükskõik, millisest maailma nurgast hallata, kuid seda on võimalik teha ka otse koduvõrgust. Linksys Smart Wi-Fi võib olla saadaval ka teie mobiilsideseadme jaoks. Lisainfo saamiseks vaadake oma seadme rakenduste poodi.

## Kuidas ühendada Linksys Smart Wi-Fi

Ühenduse loomine Linksys Smart Wi-Fi-ga

1. Avage oma arvutis veebilehitseja.
2. Minge aadressile <http://LinksysSmartWiFi.com> ja logige oma kontole sisse.

Linksys Smart Wi-Fi Sign In

If you have not yet created a Linksys Smart Wi-Fi account, click the "Create Account" button in the upper right corner of the page.

Give guests Internet access

Use your Linksys Smart Wi-Fi account to access your home network from anywhere, at any time, even from your mobile device. Easily connect new devices, set parental controls, get access to Smart Wi-Fi mobile Apps, and more.

For more information [click here](#)

English (United States)

For local access, [click here](#).

Kui teile ei meenu oma parool, kõpsake *Forgot your password?*(unustasite oma parooli?) ning järgige parooli lähtestamiseks ekraanil toodud juhiseid.

## Võrgukaart

Laseb teil kuvada ja hallata kõiki võrguseadmeid, mis on teie ruuteriga ühendatud. Võite vaadata seadmeid oma põhivõrgus ja teie külalise võrgus või kuvada teavet iga seadme kohta.



## Külalise juurdepääs

Laseb teil seadistada ja jälgida võrku külaliste jaoks, et nad pääseksid Wi-Fi-ühendusele ligi, avaldamata isiklike andmeid.

The screenshot shows the 'Guest Access' configuration page. At the top, there's a title 'Guest Access' and a checkbox 'Show widget on the homepage' which is checked. Below the title, there's a subtitle 'Guest access allows visitors to connect to your wireless guest network and access the Internet, without giving access to your other computers or personal data.' The main section is titled 'Allow guest access' and has a toggle switch set to 'ON'. To the right of this section is a warning box with an exclamation mark icon and the text: 'Your guest should first connect to your guest network, open a web browser, and then enter the guest password.' Below this, there's a section 'Guest network names and password' with an 'Edit' link. It lists two networks: '2.4 GHz SSID: parlor2.4' and '5 GHz SSID: parlor5', both with 'Network: Enabled'. Below that, it shows 'Guest network password: thefly'. At the bottom, there's a section 'Total guests allowed' with a dropdown menu set to '5 guests'. At the bottom right, there are 'OK' and 'Cancel' buttons.

## Vanemlik järelevalve

Laseb teil blokeerida veebilehed ja määrata internetile juurdepääsu aja.

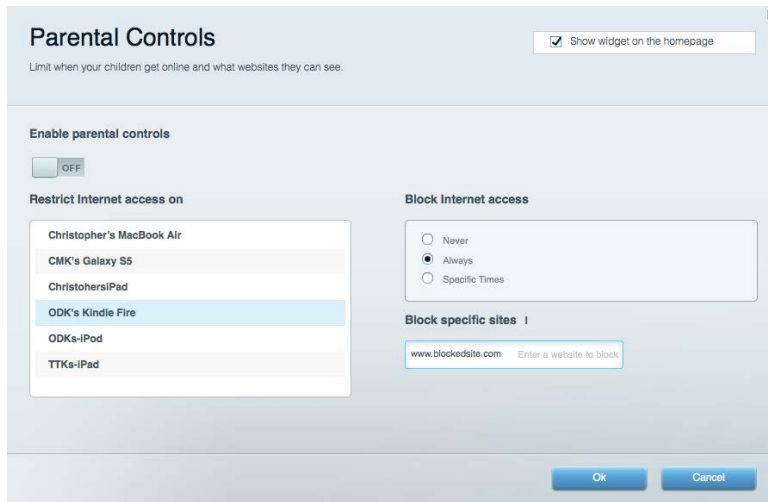

## Meedia prioritiseerimine

Võimaldab teil määrata, millised seadmed ja rakendused on teie võrgu liikluse jaoks esmatähtsad.

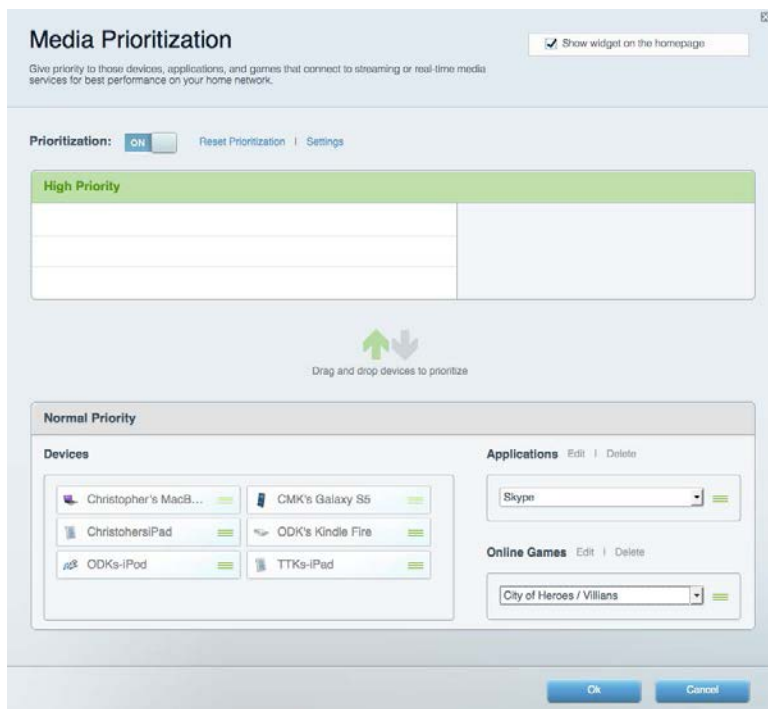

## Kiirustest

Võimaldab teil oma võrgu internetiühenduse kiirust testida.



## Välismälu

Annab teile juurdepääsu kaasasolevale USB-kettale (ei ole lisatud) ja võimaldab seadistada failide jagamist, meediaserverit ja ligipääsu FTP-serverile.

The image shows an 'External Storage' configuration window with the following details:

- External Storage Drive:** Volume name: ROUND DRIVE. A progress bar shows 'Space used: 886 MB used of 960 MB total.' Buttons: 'Safely remove drive' and 'Refresh'.
- Folder Access:** 'Secure Folder Access is OFF'. Note: 'Any user can access content via shared folders.' Fields for 'PC access (File explorer): \\192.168.1.1' and 'Mac access (Finder): smb://192.168.1.1'.
- FTP Server:** 'FTP Server is OFF'. Note: 'Content is not accessible to any user via FTP.' Field for 'FTP server: Disabled'.
- Media Server (DLNA):** 'Media Server (DLNA) is ON'. Note: 'Media content is accessible to DLNA clients.' Field for 'DLNA server: EA6050'.
- Footer:** 'Ok' button.

## Ühenduvus

Võimaldab teil vaadata ja muuta põhi- ja spetsialiseeritud võrguseadistusi.

The screenshot shows the 'Connectivity' settings page of a router. It features a navigation bar with tabs for 'Basic', 'Internet Settings', 'Local Network', 'Advanced Routing', 'VLAN', and 'Administration'. The 'Basic' tab is selected. The page is divided into several sections: 'Network Name and Password' with fields for 2.4 GHz and 5 GHz network names and passwords; 'Router Password' with a masked password field; 'Router Firmware Update' with a checked 'Automatic' option and a 'Check for Updates' button; 'Time Zone' with a dropdown menu set to '(GMT-05:00) Eastern Time (USA & Canada)' and a checked 'Automatically adjust for Daylight Savings Time' option; and 'Activity Lights' with an 'ON' toggle and a text box explaining the power light status. At the bottom, there are 'Ok', 'Cancel', and 'Apply' buttons.

## Tõrkeotsing

Võimaldab diagnoosida probleeme ruuteriga ja kontrollida võrgu staatust.

The screenshot shows the 'Troubleshooting' settings page of a router. It features a navigation bar with tabs for 'Status', 'Diagnostics', and 'Logs'. The 'Diagnostics' tab is selected. The page is divided into several sections: 'Ping IPv4' with input fields for IP or host name and number of pings, and a 'Start to Ping' button; 'Trace route' with an input field for IP or host name and a 'Start to Traceroute' button; 'Reboot' with a 'Reboot the router' link; 'Router configuration' with 'Backup' and 'Restore' buttons; 'Router Firmware' with a 'Restore previous firmware' button; 'Internet Address' showing IPv4 and IPv6 addresses with 'Release and Renew' links; and 'Factory reset' with a 'Reset to factory default settings' link. At the bottom, there is an 'Ok' button.

## Juhtmeta ühendus

Võimaldab teil vaadata ja muuta ruuteri juhtmeta võrguühendust. Võite muuta võrkude nimesid, turvarežiimi, parooli ja MAC-filtrit ning ühendada seadmed Wi-Fi Protected Setupi kaudu.

Wireless

View and change router settings

Wireless MAC Filtering Wi-Fi Protected Setup

Smart Connect:  5 GHz band steering  Off  
5 GHz<sub>1</sub> + 5 GHz<sub>2</sub> Individual networks What is Smart Connect band steering?

Network name: arachnid 2.4 GHz Network:  ON

Password: peterparker Broadcast SSID: Yes Channel: Auto

Security mode: WPA2/WPA Mixed Pt Network mode: Mixed Channel width: Auto

Network name: arachnid\_5GHz 5 GHz<sub>1</sub> + 5 GHz<sub>2</sub> Network:  ON

Password: peterparker Broadcast SSID: Yes Channel: Auto

Security mode: WPA2/WPA Mixed Pt Network mode: Auto Channel width: Auto

Ok Cancel Apply

## Turvalisus

Võimaldab teil vaadata ja muuta ruuteri juhtmeta ühenduse turvalisust. Võite seadistada tulemüüri, VPN-seadistused ja teha eriseadistusi rakenduste ja mängude jaoks.

Security

View and change router settings

Firewall DMZ Apps and Gaming

**Firewall**

IPv4 SPI firewall protection  Enabled

IPv6 SPI firewall protection  Enabled

**Internet filters**

Filter anonymous Internet requests

Filter multicast

Filter Internet NAT redirection

Filter ident (Port 113)

**VPN Passthrough**

IPSec Passthrough  Enabled

PPTP Passthrough  Enabled

L2TP Passthrough  Enabled

**IPv6 Port Services**

Description	Protocol	IPv6 Address	Allow	Enabled
-------------	----------	--------------	-------	---------

Add IPv6 Firewall Setting

Ok Cancel Apply

# Tõrkeotsing

Lisateavet leiate meie auhinnatud klienditoe leheküljelt [linksys.com/support/EA8300](https://linksys.com/support/EA8300).

## Teie ruuteri seadistamine ebaõnnestus

Kui Linksys Smart Wi-Fi seadistamine ei õnnestunud, proovige järgmist.

- Vajutage ja hoidke kirjaklambrit või nõela kasutades all oma ruuteri lähtestamisnuppu, kuni valgustatud Linksysse logo süttib ja sinine MU-MIMO indikaator hakkab vilkuma (umbes 10 sekundit). Seadistage ruuter uuesti.

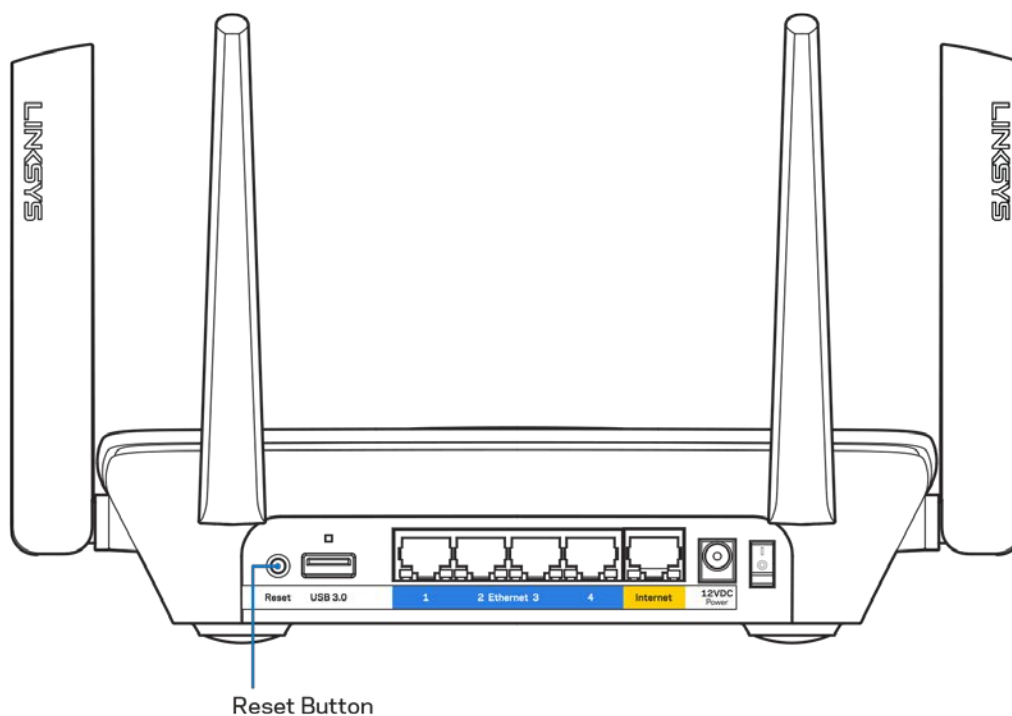

- Lülitage oma arvuti tulemüür ajutiselt välja (vt abi saamiseks turvalisustarkvara juhiseid). Seadistage ruuter uuesti.
- Kui teil on olemas teine arvuti, kasutage seda ruuteri taaseadistamiseks.

## Teade *Your Internet cable is not plugged in* (teie internetikaabel ei ole ühendatud)

Kui ruuteri seadistamisel kuvatakse teade „Teie internetikaabel ei ole ühendatud”, proovige järgmisi veaotsinguvõtteid.

- Veenduge, et ethernet või internetikaabel (või koos ruuteriga kaasas olev kaabel) on ühendatud kindlalt kollase WAN-pordiga ruuteri tagumisel küljel, ja teie modemil sobiva pordiga. Tavaliselt on sellel modemi pordil kiri „Ethernet” .

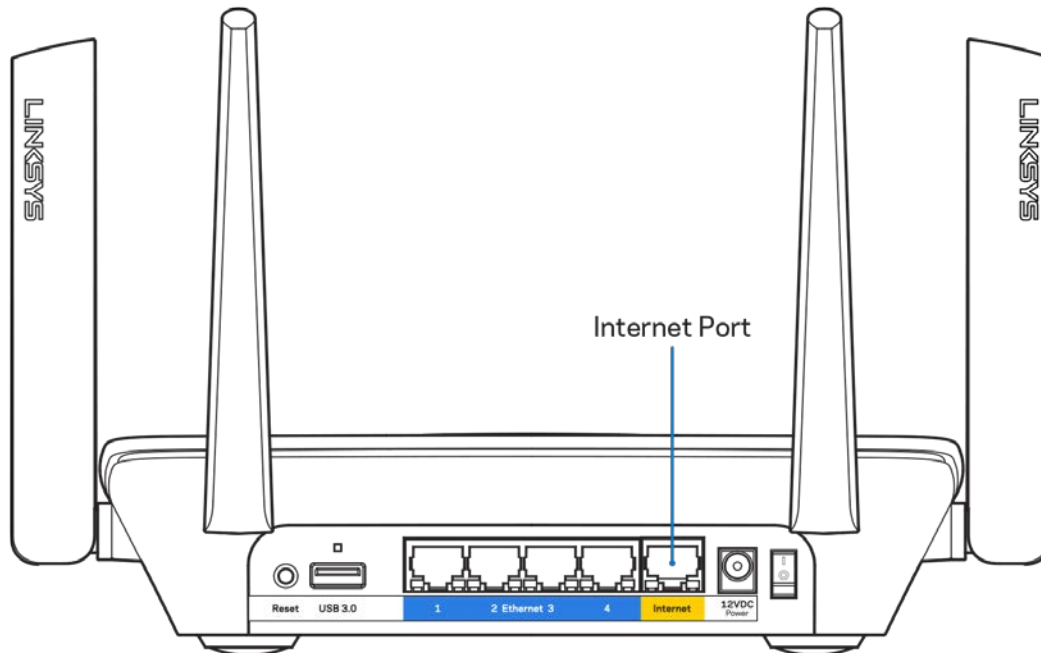

- Veenduge, et teie modem on toitega ühendatud ja sisse lülitatud. Kui sellel on toitelüliti, tuleb veenduda, et see on asendis ON või | (mitte asendis O).

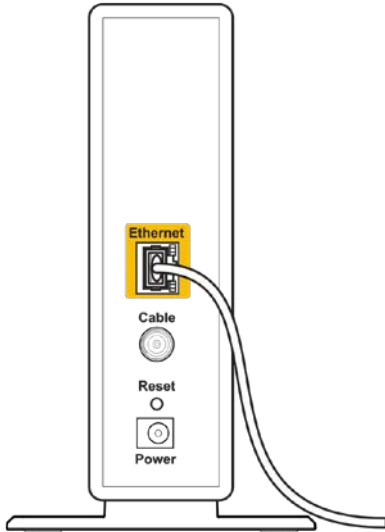
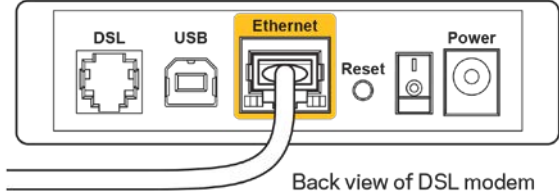

 <p>Back view of cable modem</p>	 <p>Back view of DSL modem</p>
<p>Kui teie internetiteenus on kaabliga, siis veenduge, et kaabliga modemi KAABLI port on ühendatud teie interneti teenusepakkuja poolt antud koaksiaalkaabliga.</p>	<p>Kui teie internetiteenus on DSL-ühendusega, tuleb veenduda, et DSL-telefoniliin on ühendatud modemi DSL-pordiga.</p>

- Kui teie arvuti oli ühendatud eelnevalt teie modemiga USB-kaabli abil, tuleb USB-kaabli ühendus katkestada.
- Seadistage ruuter uuesti.

## Teade *Cannot access your router* (puudub juurdepääs ruuterile)

Ruuterile juurdepääsu saamiseks peate olema võrku ühendatud. Kui teil on hetkel juhtmeta internetiühendus, võib probleemiks olla see, et olete kogemata ühenduse loonud mõne teise raadiovõrguga.

Windowsi arvutite puhul järgige probleemi lahendamiseks järgmisi samme\*:

1. Klõpsake süsteemisalve juhtmevaba ühenduse ikoonil. Kuvatakse olemasolevate juhtmeta võrkude loend.

2. Klõpsake oma võrgu nimele. Klõpsake nupul Connect (Ühenda). Allolevas näites oli arvuti ühendatud teise juhtmevaba võrguga nimega wraith\_5GHz. Selles näites on valitud ruuteri Linksys EA8300 võrgu nimi Damaged\_Beez2.4.



3. Kui teil palutakse sisestada võrgu turbevõti, sisestage oma parool (turbevõti) võrguturbevõtme väljale. Klõpsake nupul OK.
4. Teie arvuti ühendub võrguga ning peaksite ruuterile ligi pääsema.

*\*Olenevalt teie Windowsi versioonist võib esineda erinevusi sammude sõnastuses või ikoonides.*

Maci arvutite puhul järgige probleemi lahendamiseks järgmisi samme:

1. Klõpsake akna ülaosas oleval menüüribal Wi-Fi ikoonil. Kuvatakse juhtmeta võrkude loend.
2. Allolevas näites oli arvuti ühendatud teise juhtmevaba võrguga nimega wraith\_5GHz. Selles näites on valitud ruuteri Linksys EA8300 võrgu nimi Damaged\_Beez2.4.



3. Klõpsake oma Linksys EA8300 ruuteri juhtmeta võrguühenduse nimel (näites `Damaged_Beez2.4`).
4. Sisestage oma juhtmevaba võrgu parool (turbevõti) väljale *Password* (Parool). Klõpsake nupul **OK**.

## Pärast seadistamist

### Internetiga ei ole võimalik ühendust luua

Kui internetil on teie ruuteriga suhtlemisel raskusi, võidakse veebilehitsejas kuvada veateade „Cannot find [internet address]” ([internetiaadressi] ei leitud). Kui te teate, et internetiaadress on õige ja olete mitme õige internetiaadressi proovimisel sama tulemuse saanud, võib teade tähendada, et probleem on teie internetiteenuse pakkujas või modemi ja ruuteri vahelises ühenduses. Proovige järgmist:

- Veenduge, et võrgukaabel ja toitekaabel on korralikult ühendatud.
- Veenduge, et pistikus, kuhu teie ruuter on ühendatud, on vool.
- Taaskäivitage ruuter.
- Võtke ühendust oma internetiteenuse pakkujaga ning küsige teie piirkonnas esinevate katkestuste kohta.

Kõige tavalisem ruuteri tõrke lahendamise viis on selle välja ja siis uuesti sisse lülitamine. Teie ruuter saab siis oma isikupärastatud sätteid uuesti laadida ning muud seadmed (näiteks modem) saavad ruuteri uuesti leida ja sellega suhelda. Seda protsessi kutsutakse taaskäivitamiseks.

Ruuteri toitekaabli abil taaskäivitamiseks toimige järgmiselt:

1. Ühendage toitekaabel ruuterist ja modemist lahti.
2. Oodake 10 sekundit ning ühendage toitekaabel uuesti modemiga. Veenduge, et modem on vooluvõrku ühendatud.
3. Oodake, kuni modemi võrgutuli on vilkumise lõpetanud (ligikaudu kaks minutit). Ühendage toitekaabel uuesti ruuteriga.
4. Oodake, kuni valgustatud Linksys logo süttib. Oodake kaks minutit, enne kui proovite arvutiga internetiühenduse luua.

Ruuteri Linksys Smart Wi-Fi abil taaskäivitamiseks toimige järgmiselt:

1. Logige sisse Linksys Smart Wi-Fi-sse. (Vaadake „Kuidas avada Linksys Smart Wi-Fi” leheküljel [11](#).)
2. Klõpsake nupul *Troubleshooting* (tõrkeotsing), mis asub menüüs *Router Settings* (ruuteri sätteid).
3. Klõpsake vahekaardil *Diagnostics* (diagnostika).
4. Klõpsake alal *Reboot* (taaskäivõtmine) nupul *Reboot* (taaskäivita).



5. Vajutage Yes (**Jah**). Ruuter taaskäivitub. Kõik ühendatud seadmed kaotavad ruuteri taaskäivitumise ajaks oma internetiühenduse ning ühenduvad automaatselt uuesti, kui ruuter on valmis.

## Linksys Smart Wi-Fi ei avane veebilehitsejas

Linksys Smart Wi-Fi-ga töötavad Google Chrome™-i, Firefox®-i, Safari® (Mac®-i ja iPad®-i jaoks), Microsoft Edge'i uusimad versioonid ning Internet Explorer®-i versioon 8 ja uuemad versioonid.

# Tehnilised andmed

## Linksys EA8300

Mudeli nimetus	Max-Stream AC2200 MU-MIMO kolmeribaline ruuter
Mudeli number	EA8300
Kommutaatori pordi kiirus	10/100/1000 Mb/s (Gigabit Ethernet)
Raadiosagedus	2,4 GHz ja 5 GHz (x2)
Antennide arv	4 välist reguleeritavat antenni (ei ole eemaldatavad)
Pordid	USB 3.0, Ethernet (1-4), internet, toide
Nupud	Wi-Fi Protected Setup, toide, lähtestamine
Tuled	<b>Ülemine paneel:</b> Valgustatud Linksyse logo, Wi-Fi Protected Setup, internetiühendus, võrgukaabli ühendus internetipordiga <b>Tagumine paneel:</b> USB, Ethernet (1-4), internet
UPnP	Toetatud
Turvaomadused	WEP, WPA2, RADIUS
Turbevõtme bitid	Kuni 128-bitine krüptimine
Salvestustuumi failisüsteemi tugi	FAT, NTFS ja HFS+
Toetatavad brauserid	Brauserite Google Chrome™, Firefox®, Safari® (Mac® ja iPad®), Microsoft Edge uusimad versioonid ning Internet Explorer®-i versioon 8 ja uuemad versioonid.

## Keskkondlik

Mõõtmed	213,7 mm x 161,8 mm x 54,8 mm (antennideta)
Seadme kaal	608 g
Toide	12 V, 2A
Sertifikaadid	FCC, IC, CE, Wi-Fi (a/b/g/n/ac)
Kasutamistemperatuur	32 kuni 104 °F (0 kuni 40 °C)
Hoiundamistemperatuur	-4 kuni 140°F (-20 kuni 60°C)
Kasutamisiiskus	10% kuni 80% suhteline õhuniiskus, mittekondenseeruv
Hoidmisiiskus	5% kuni 90% mittekondenseeruv

Jätame endale õiguse teha muudatusi tehnilises teabes teid teavitamata.

## Märkused

Regulatiivse, garantiid ja ohutust puudutava teabe leiate ruuteriga kaasas olevalt CD-lt või veebilehelt [Linksys.com/support/EA8300](http://Linksys.com/support/EA8300).

Maksimaalne sooritus põhineb IEEE standardi 802.11 tehnilistel andmetel. Tegelik sooritus võib varieeruda, kaasa arvatud madalam juhtmeta võrguühenduse võimsus, andmete liikumiskiirus, ulatus ja kaetus. Sooritus sõltub paljudest teguritest, tingimustest ja muutujatest, kaasa arvatud juurdepääsupunktide kaugusest, võrguliikluse mahust, toote materjalist ja ehitusest, kasutatud operatsioonisüsteemist, kasutatud juhtmeta toodete kombinatsioonist, sekkumisest ja muudest ebasoodsatest asjaoludest.

BELKIN, LINKSYS ja mitmed muud tootenimed ja logod on Belkini ettevõtete grupi kaubamärgid. Nimetatud kolmandate osapoolte kaubamärgid on vastavate omanike omandid. Kolmanda osapoole tarkvara litsentse ja teatise, mida selles tootes kasutatakse, saate vaadata siit: <http://support.linksys.com/en-us/license>. Võtke ühendust aadressil <http://support.linksys.com/en-us/gplcodecenter>, kui teil on küsimusi või soovite GNU avaliku litsentsi lähtekoodi.

© 2017 Belkin International, Inc. ja/või selle tütarettevõtted. Kõik õigused kaitstud.

**LINKSYS®**

Käyttöopas

**MAX-STREAM™  
AC2200 MU-MIMO  
KOLMITAAJUUKSINEN  
REITITIN**

Malli EA8300

# Sisällys

Tuotteen yleiskatsaus.....	3
Laite ylhäältä.....	3
Järjestelmän tilan merkkivalo.....	4
Laite takaa.....	5
Laite sivulta.....	6
Käytön aloittaminen: Perusteet.....	7
Lisäohjeiden hakeminen.....	7
Reitittimen asentaminen.....	8
Linksys Smart Wi-Fi -tilin käyttäminen.....	11
Yhteyden muodostaminen Linksys Smart Wi-Fi -tiliin.....	11
Verkkokartta.....	12
Vieraskäyttö.....	12
Käytönvalvonta.....	13
Etusijan antaminen.....	13
Nopeustesti.....	14
Ulkoisen tallennustila.....	14
Liitettävyys.....	15
Vianmääritys.....	15
Langaton.....	16
Tietoturva.....	16
Vianmääritys.....	17
Reitittimen määrittely epäonnistui.....	17
<i>Internet-kaapelia ei ole liitetty</i> -viesti.....	18
<i>Reititintä ei voi avata</i> -viesti.....	19
Asennuksen jälkeen.....	21
Internet-yhteys ei ole käytettävissä.....	21
Linksys Smart Wi-Fi ei avaudu selaimeen.....	22
Tekniset tiedot.....	23
Linksys EA8300.....	23
Käyttöympäristötiedot.....	23



# Tuotteen yleiskatsaus

## Laite ylhäältä

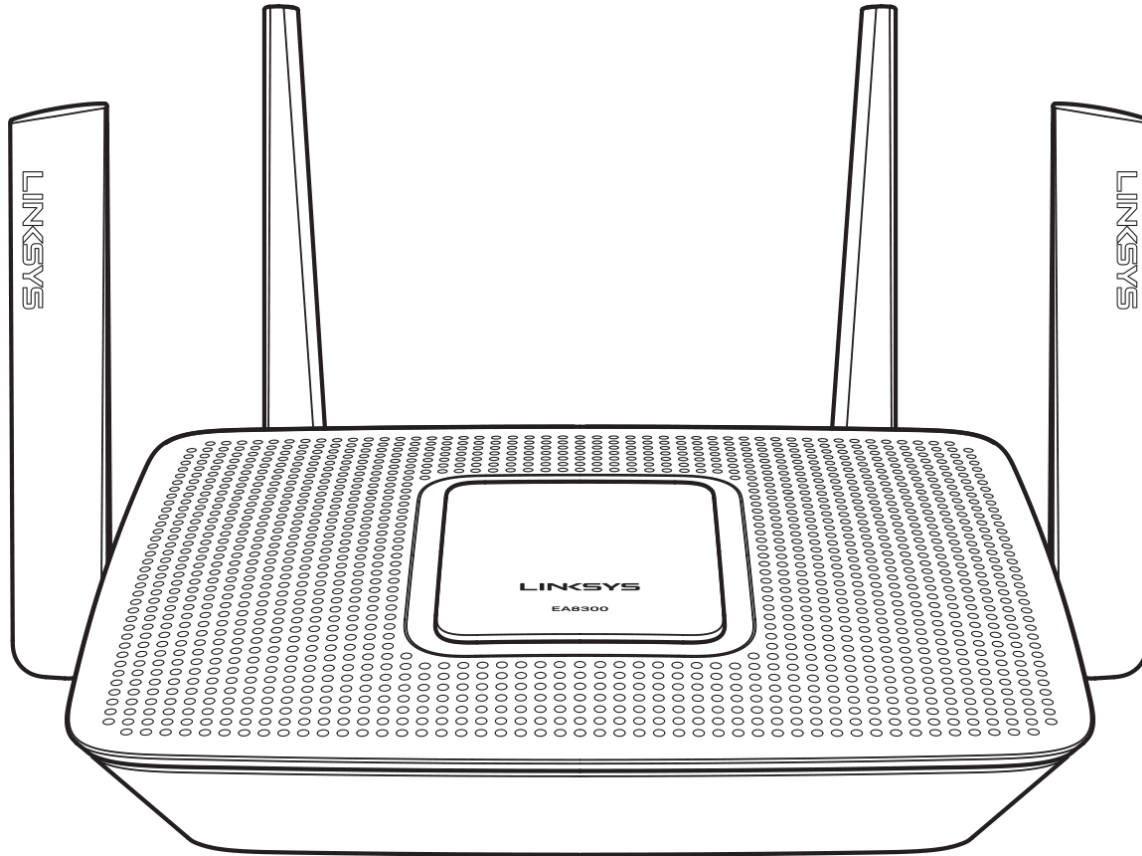

## Järjestelmän tilan merkkivalo

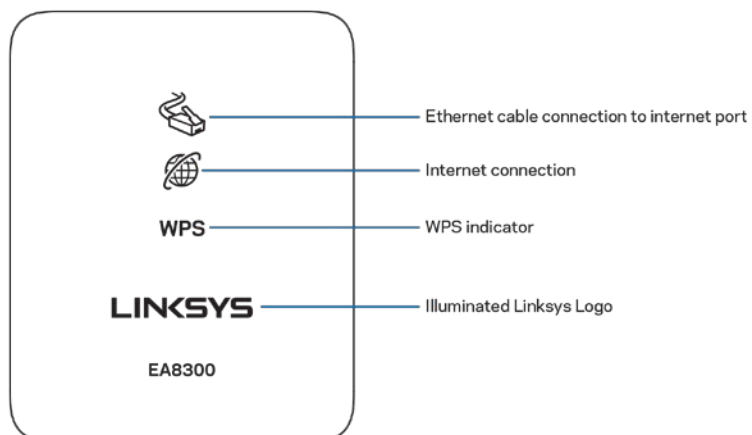

**Ethernet-kaapelin kytkentä Internet-porttiin** - Merkkivalo (oranssi) ilmoittaa ongelmasta verkkokaapelin liittäessä Internet (WAN) -porttiin.

**Internet-yhteys** - Merkkivalo (oranssi) tarkoittaa, että reititin ei ole yhteydessä Internetiin.

**WPS (Wi-Fi Protected Setup™) -merkkivalo** - WPS-valolla on neljä tilaa:

<b>Ei pala</b>	Ei Wi-Fi Protected Setup -toimintaa
<b>Vilkkuva valkoinen</b>	Wi-Fi Protected Setup -toiminto on käynnissä
<b>Tasainen valkoinen</b>	Wi-Fi Protected Setup -toiminto onnistui; valo palaa viisi sekuntia
<b>Vilkkuva oranssi</b>	Wi-Fi Protected Setup -virhe; vilkkuu minuutin ajan ja sammuu

**Linksys-logovalo** - Logo vilkkuu reitittimen käynnistyessä. Kun logo palaa valkoisena, reititin on käynnissä ja toimii oikein.

## Laite takaa

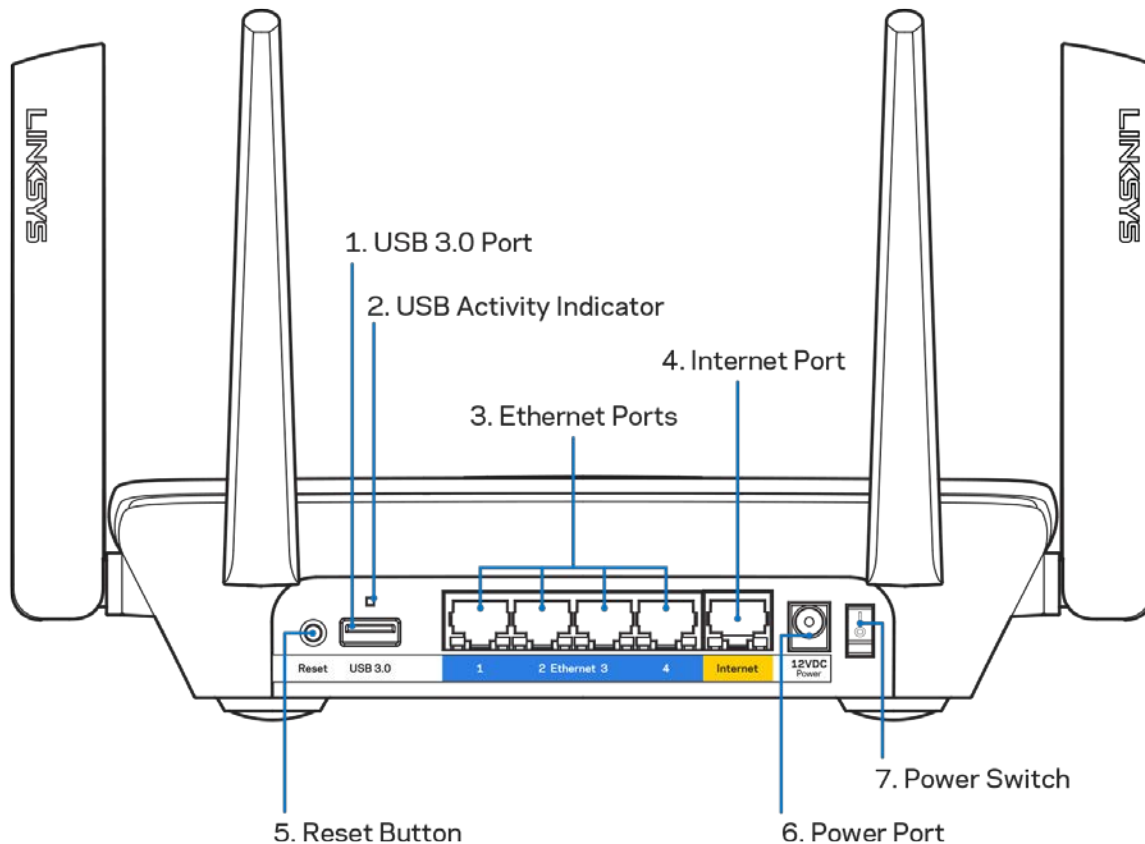

**USB 3.0 -portti (1)** - Kytke USB-asemia jaettavaksi lähiverkossa tai Internetissä.

**USB-toiminnan merkkivalo (2)** - Palaa, kun tietoja siirretään ulkoisten laitteiden välillä.

**Ethernet-portit (3)** - Kytke Ethernet-kaapelit sinisiin Gigabit (10/100/1000) -portteihin ja langallista verkkoyhteyttä käyttävin laitteisiin.

*Huomautus: paras suorituskyky saadaan käyttämällä Ethernet-porteissa vähintään CAT5e-luokan kaapeleita.*

**Internet-portti (4)** - Kytke Ethernet-kaapeli keltaiseen Gigabit (10/100/1000) -porttiin ja laajakaistayhteyden kaapeli-, DSL- tai valokuitumodeemiin.

*Huomautus: paras suorituskyky saadaan käyttämällä Internet-portissa vähintään CAT5e-luokan kaapelia.*

**Nollauspainike (5)** - Voit palauttaa reitittimen tehdasasetukset pitämällä tätä painiketta painettuna, kunnes Linksys-logovalo sammuu. Voit palauttaa tehdasasetukset myös Linksys Smart Wi-Fi -tilin kautta Internet-selaimella tai mobiilisovelluksella.

**Virtaliitäntä (6)** - Kytke mukana toimitettu verkkovirtasovitin tähän liitäntään.

**Virtakytkin (7)** - Käynnistä reititin painamalla kytkin | (on) -asentoon.

## Laite sivulta

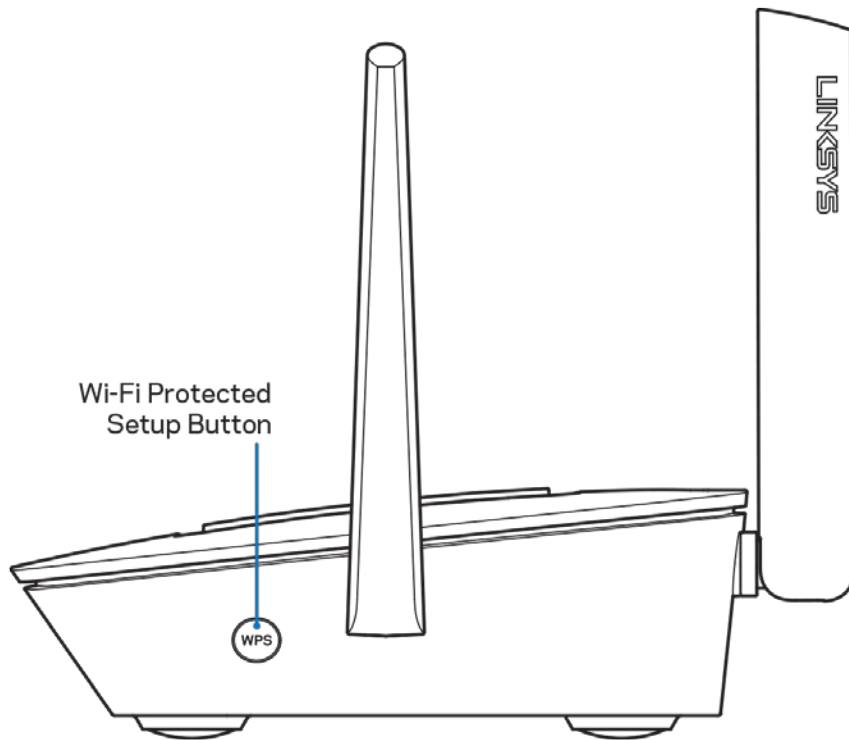

**Wi-Fi Protected Setup™ -painike** - Yhdistä WPS-yhteensopivia verkkolaitteita painamalla tätä painiketta.

# Käytön aloittaminen: Perusteet

## Lisäohjeiden hakeminen

Tämän käyttöoppaan lisäksi voit tutustua seuraaviin ohjeresursseihin:

- [Linksys.com/support/EA8300](http://Linksys.com/support/EA8300) (käyttöoppaat, lataukset, usein kysytyt kysymykset, tekninen tuki, tukipalvelun keskustelutoiminto, keskustelupalstat)
- Linksys Smart Wi-Fi -ohje (Kirjaudu Linksys Smart Wi-Fi -tiliin ja valitse näytön yläosassa Ohje.)

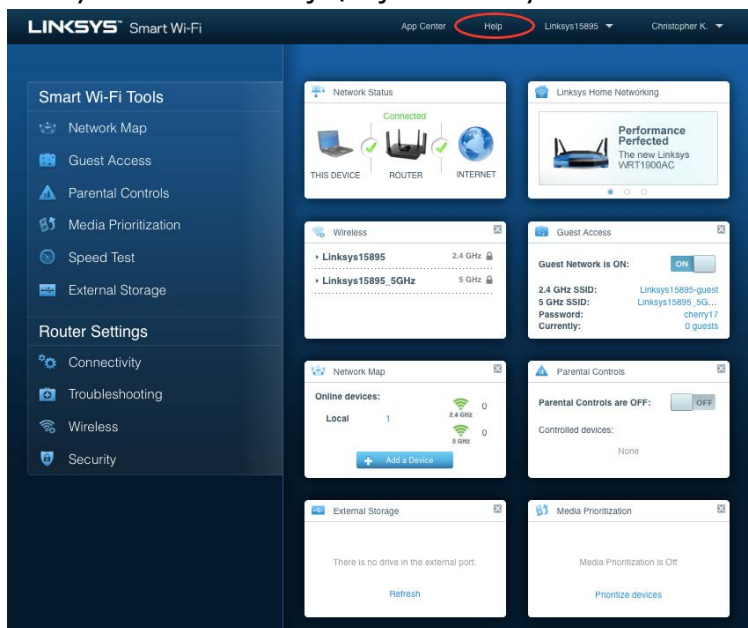

The screenshot shows the Linksys Smart Wi-Fi app interface. At the top, there is a navigation bar with 'App Center', 'Help' (highlighted with a red circle), 'Linksys15895', and 'Christopher K.'. The main area is divided into several sections: 'Smart Wi-Fi Tools' (Network Map, Guest Access, Parental Controls, Media Prioritization, Speed Test, External Storage), 'Router Settings' (Connectivity, Troubleshooting, Wireless, Security), and a grid of widgets for Network Status, Linksys Home Networking, Wireless, Guest Access, Network Map, Parental Controls, External Storage, and Media Prioritization. Below this is a 'Help' section with the title 'Using Linksys Smart Wi-Fi' and a list of help categories: Linksys Smart Wi-Fi, Device List, Guest Access, Parental Controls, Media Prioritization, Speed Test, External Storage, and Connectivity. An 'Ok' button is at the bottom right.

**Huomautus:** Tuotteessa käytetyn kolmannen osapuolen ohjelmiston lisenssit ja ilmoitukset ovat saatavilla osoitteessa <http://support.linksys.com/en-us/license>. Lisätietoja GPL-lisenssistä ja lähdekoodin pyyntölomake on osoitteessa <http://support.linksys.com/en-us/gplcodecenter>.

## Reitittimen asentaminen

1. Viimeistele asennus avaamalla tietokoneen selaimeen osoite <http://LinksysSmartWiFi.com>.
2. Valitse laitteesi.

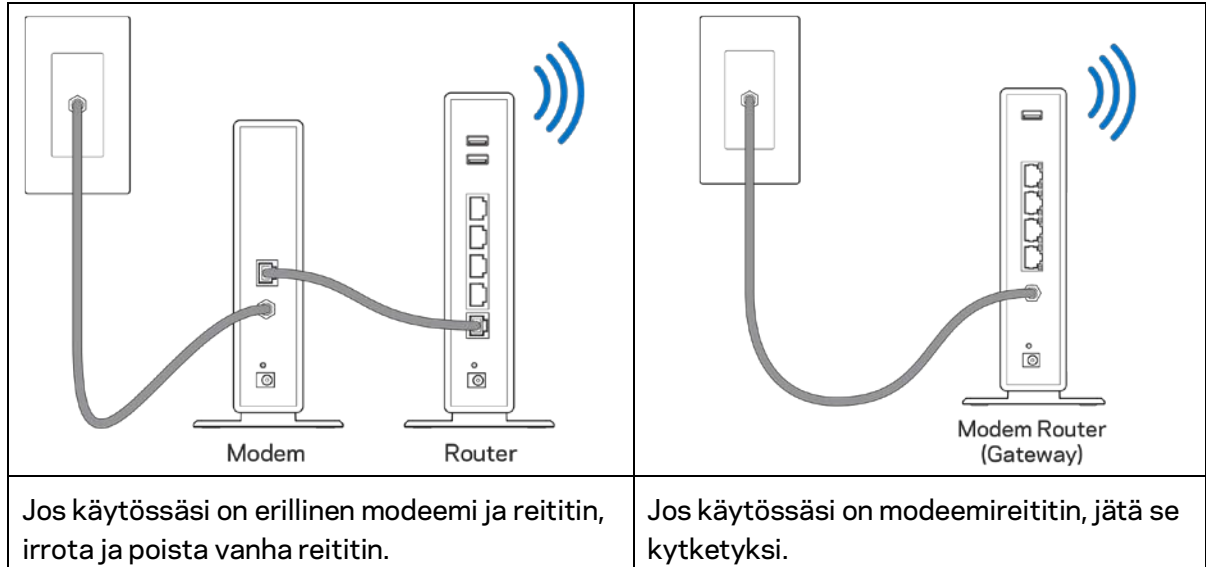

3. Säädä antennit pystyasentoon ja kytke reititin pistorasiaan. Varmista, että virtakytkin on | (on) -asennossa.
4. Kytke reititin modeemiin tai modeemireitittimeen. Kytke mukana toimitetun Internet-kaapelin toinen pää uuden reitittimen keltaiseen Internet-porttiin. Jos käytössäsi on modeemi, kytke toinen pää modeemin Ethernet (LAN) -porttiin. Jos käytössäsi on modeemireititin, kytke kaapeli mihin tahansa vapaana olevaan porttiin.
5. Odota, kunnes reitittimen päällä oleva Linksys-logovalo lakkaa vilkkumasta ja palaa tasaisesti valkoisena.
6. Muodosta yhteys Wi-Fi-verkkoon, jonka nimi on mainittu reitittimen mukana toimitetussa pikaaloitusoppaassa. (Voit muuttaa näitä tietoja myöhemmin.) Lisätietoja verkkoyhteyden muodostamisesta on laitteen käyttöohjeissa osoitteessa [linksys.com/support/EA8300](http://linksys.com/support/EA8300).

**Huomautus:** Et voi käyttää Internetiä, ennen kuin reitittimen asetukset on määritetty.

7. Kirjoita selaimen osoiteriville <http://LinksysSmartWiFi.com>. Viimeistele reitittimen asennus noudattamalla näyttöön tulevia ohjeita. Voit avata asetusliittymän myös kirjoittamalla selaimen osoiteriville 192.168.1.1.

Määritä Linksys Smart Wi-Fi -tili noudattamalla asennuksen lopussa näyttöön tulevia ohjeita. Linksys Smart Wi-Fi -tilin avulla voit määrittää reitittimen asetukset millä tahansa tietokoneella, jossa on Internet-yhteys.

Reitittimen asetusnäytössä voit

- muuttaa reitittimen nimen ja salasanan
- määrittää vieraskäytön
- määrittää lapsilukon
- liittää laitteita Wi-Fi-verkkoon
- testata Internet-yhteyden nopeuden.

**Huomautus:** *Linksys Smart Wi-Fi -tilin määrittämisen aikana sinulle lähetetään vahvistussähköpostiviesti. Yhdistä reititin Linksys Smart Wi-Fi -tiliin napsauttamalla sähköpostiviestissä olevaa linkkiä kotiverkkoon yhdistetyssä laitteessa.*

**Vihje:** *Tulosta seuraava sivu ja kirjoita reitittimen ja tilin asetukset taulukkoon myöhempää käyttöä varten. Säilytä muistiinpanojasi turvallisessa paikassa.*

2,4 GHz:n verkon Wi-Fi-nimi	
Wi-Fi-salasana	
5 GHz <sub>1</sub> :n verkon Wi-Fi-nimi	
Wi-Fi-salasana	
5 GHz <sub>2</sub> :n verkon Wi-Fi-nimi	
Wi-Fi-salasana	
Reitittimen salasana	
2,4 GHz:n vieras-Wi-Fi:n nimi	
5 GHz:n vieras-Wi-Fi:n nimi	
Vieras-Wi-Fi:n salasana (Molemmilla on sama salasana.)	
Linksys Smart Wi-Fi-käyttäjänimi	
Linksys Smart Wi-Fi-salasana	



# Linksys Smart Wi-Fi -tilin käyttäminen

Voit muuttaa reitittimen asetuksia missä tahansa oletkin Linksys Smart Wi-Fi -tilin avulla. Voit toki määrittää asetukset myös suoraan kotiverkossa. Linksys Smart Wi-Fi -tiliä voi käyttää myös monilla mobiililaitteilla. Katso lisätietoja laitteesi sovelluskaupasta.

## Yhteyden muodostaminen Linksys Smart Wi-Fi -tiliin

Muodosta yhteys Linksys Smart Wi-Fi -tiliin seuraavasti:

1. Avaa tietokoneen selain.
2. Siirry osoitteeseen <http://LinksysSmartWiFi.com> ja kirjaudu sisään tiliisi.

Linksys Smart Wi-Fi Sign In

If you have not yet created a Linksys Smart Wi-Fi account, click the "Create Account" button in the upper right corner of the page.

Give guests Internet access

Use your Linksys Smart Wi-Fi account to access your home network from anywhere, at any time, even from your mobile device. Easily connect new devices, set parental controls, get access to Smart Wi-Fi mobile Apps, and more.

For more information [click here](#)

English (United States)

For local access, [click here](#).

Jos et muista salasanaasi, napsauta *Unohditko salasanan?*-linkkiä ja palauta salasana näyttöön tulevien ohjeiden mukaisesti.

## Verkkokartta

Voit tarkastella ja hallita kaikkia reitittimeen liitettyjä verkkolaitteita. Voit tarkastella pää- ja vierasverkon laitteita ja näyttää kunkin laitteen tiedot.



## Vieraskäyttö

Voit määrittää ja hallita Wi-Fi-verkon vieraskäytön jakamatta henkilökohtaisia tietojasi.

The screenshot shows the 'Guest Access' configuration page. At the top, there is a title 'Guest Access' and a checkbox 'Show widget on the homepage' which is checked. Below the title, there is a subtitle 'Guest access allows visitors to connect to your wireless guest network and access the Internet, without giving access to your other computers or personal data.' The main area is divided into several sections: 'Allow guest access' with a toggle switch set to 'ON'; 'Guest network names and password' with an 'Edit' link, showing settings for 2.4 GHz SSID (parlor2.4, Network: Enabled) and 5 GHz SSID (parlor5, Network: Enabled), and a 'Guest network password' field containing 'theyfy'; and 'Total guests allowed' with a dropdown menu set to '5 guests'. An orange warning icon with an exclamation mark is present, with the text: 'Your guest should first connect to your guest network, open a web browser, and then enter the guest password.' 'OK' and 'Cancel' buttons are at the bottom.

## Käytönvalvonta

Voit estää sivustoja ja määrittää Internet-käyttöajat.

**Parental Controls**  Show widget on the homepage

Limit when your children get online and what websites they can see.

**Enable parental controls**

OFF

**Restrict Internet access on**

- Christopher's MacBook Air
- CMK's Galaxy S5
- ChristohersiPad
- ODK's Kindle Fire**
- ODKs-iPod
- TTKs-iPad

**Block Internet access**

Never  
 Always  
 Specific Times

**Block specific sites** |

www.blockedsite.com Enter a website to block

Ok Cancel

## Etusijan antaminen

Voit määrittää, mitkä laitteet ja sovellukset ovat etusijalla verkon kaistanleveyden käytössä.

**Media Prioritization**  Show widget on the homepage

Give priority to those devices, applications, and games that connect to streaming or real-time media services for best performance on your home network.

**Prioritization:**  ON [Reset Prioritization](#) | [Settings](#)

**High Priority**

Drag and drop devices to prioritize

**Normal Priority**

**Devices**

Christopher's MacB...	CMK's Galaxy S5
ChristohersiPad	ODK's Kindle Fire
ODKs-iPod	TTKs-iPad

**Applications** Edit | Delete

Skype

**Online Games** Edit | Delete

City of Heroes / Villians

Ok Cancel

## Nopeustesti

Voit testata verkon Internet-yhteyden nopeutta.



## Ulkoinen tallennustila

Voit käyttää reitittimeen liitettyä USB-asemaa (ei sisälly toimitukseen) ja määrittää tiedostojen jakamisen, mediapalvelimen ja FTP-yhteyden asetukset.

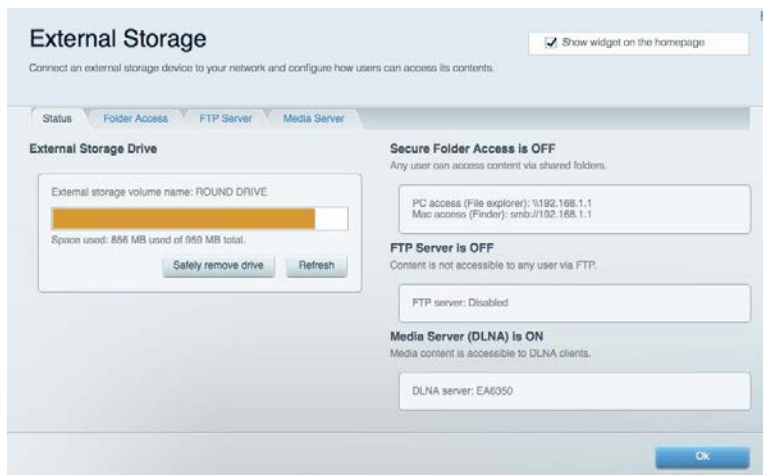

## Liitettävyy

Voit tarkastella ja muuttaa verkon perus- ja lisäasetuksia.

The screenshot shows the 'Connectivity' settings page. It has a title bar with a close button. Below the title is a subtitle 'View and change router settings'. There are several tabs: 'Basic', 'Internet Settings', 'Local Network', 'Advanced Routing', 'VLAN', and 'Administration'. The 'Basic' tab is selected. The page is divided into several sections: 'Network Name and Password' with fields for 2.4 GHz and 5 GHz network names and passwords; 'Router Password' with a masked password field; 'Router Firmware Update' with a checked 'Automatic' checkbox and a 'Check for Updates' button; 'Time Zone' with a dropdown menu set to '(GMT-05:00) Eastern Time (USA & Canada)' and a checked 'Automatically adjust for Daylight Savings Time' checkbox; and 'Activity Lights' with an 'ON' toggle and a text box explaining the power light behavior. At the bottom are 'Ok', 'Cancel', and 'Apply' buttons.

## Vianmääritys

Voit selvittää reitittimen ongelmia ja tarkistaa verkon tilan.

The screenshot shows the 'Troubleshooting' page. It has a title bar with a close button. Below the title is a subtitle 'Troubleshoot router settings'. There are three tabs: 'Status', 'Diagnostics', and 'Logs'. The 'Diagnostics' tab is selected. The page is divided into several sections: 'Ping IPv4' with input fields for IP or host name and number of pings, and a 'Start to Ping' button; 'Trace route' with an input field for IP or host name and a 'Start to Traceroute' button; 'Reboot' with a 'Reboot the router' link; 'Router configuration' with 'Backup' and 'Restore' buttons; 'Router Firmware' with a 'Restore previous firmware' button; 'Internet Address' with IPv4 and IPv6 addresses and 'Release and Renew' links; and 'Factory reset' with a 'Reset to factory default settings' link. At the bottom is an 'Ok' button.

## Langaton

Voit tarkastella ja muuttaa reitittimen langatonta verkkoa. Voit muuttaa verkkonimiä, suojaustilaa, salasanaa, MAC-suodatusta ja yhdistää laitteita Wi-Fi Protected Setup -toiminnolla.

Wireless

View and change router settings

Wireless MAC Filtering Wi-Fi Protected Setup

Smart Connect:  5 GHz band steering  Off  
5 GHz<sub>1</sub> + 5 GHz<sub>2</sub> Individual networks What is Smart Connect band steering?

Network name: arachnid 2.4 GHz Network:  ON

Password: peterparker Broadcast SSID: Yes Channel: Auto

Security mode: WPA2/WPA Mixed Pt Network mode: Mixed Channel width: Auto

Network name: arachnid\_5GHz 5 GHz<sub>1</sub> + 5 GHz<sub>2</sub> Network:  ON

Password: peterparker Broadcast SSID: Yes Channel: Auto

Security mode: WPA2/WPA Mixed Pt Network mode: Auto Channel width: Auto

Ok Cancel Apply

## Tietoturva

Voit tarkastella ja muuttaa reitittimen langattoman verkon suojausta. Voit määrittää palomuurin ja VPN-asetukset sekä määrittää omia asetuksiasi sovelluksille ja peleille.

Security

View and change router settings

Firewall DMZ Apps and Gaming

**Firewall**

IPv4 SPI firewall protection  Enabled

IPv6 SPI firewall protection  Enabled

**VPN Passthrough**

IPSec Passthrough  Enabled

PPTP Passthrough  Enabled

L2TP Passthrough  Enabled

**Internet filters**

Filter anonymous internet requests

Filter multicast

Filter internet NAT redirection

Filter ident (Port 113)

**IPv6 Port Services**

Description	Protocol	IPv6 Address	Allow	Enabled
-------------	----------	--------------	-------	---------

Add IPv6 Firewall Setting

Ok Cancel Apply

# Vianmääritys

Lisätietoja saat palkitusta asiakastuestamme osoitteessa [Linksys.com/support/EA8300](https://Linksys.com/support/EA8300).

## Reitittimen määrittäminen epäonnistui

Jos Linksys Smart Wi-Fi -reitittimen määrittäminen ei onnistu, kokeile seuraavia toimia:

- Paina reitittimen nollauspainiketta paperiliittimellä tai nuppineulalla, kunnes Linksys-logovalo sammuu ja siniset MU-MIMO-merkkivalot alkavat vilkkua (noin 10 sekuntia). Asenna reititin uudelleen.

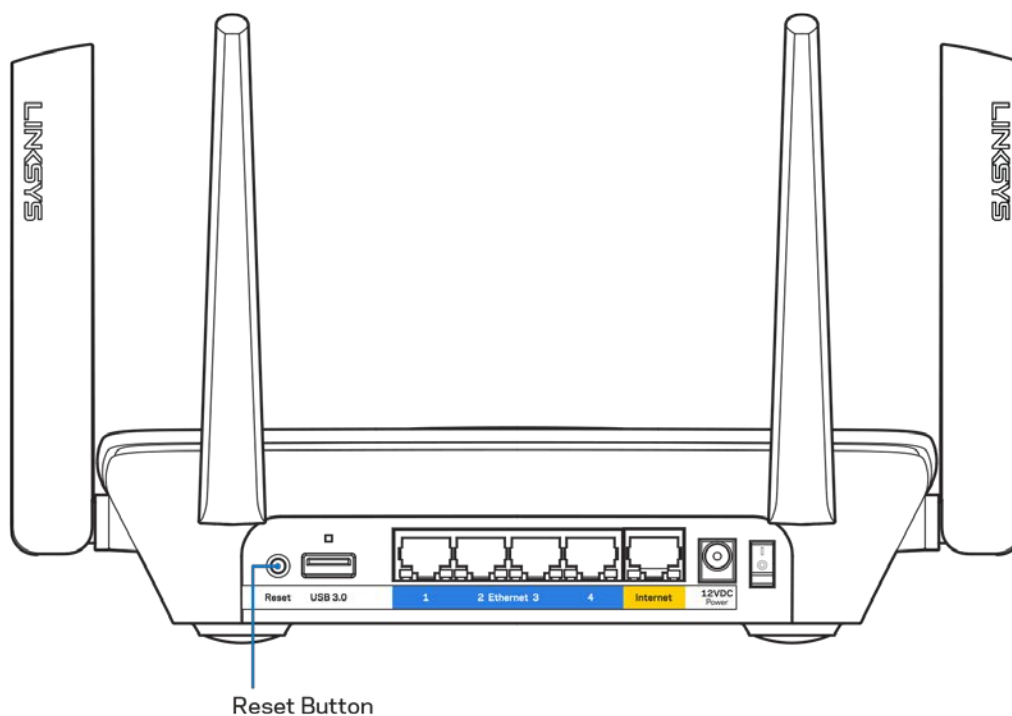

- Poista tietokoneen palomuuri käytöstä väliaikaisesti (katso ohjeet tietoturvaohjelmiston käyttöoppaasta). Asenna reititin uudelleen.
- Jos käytettävissä on toinen tietokone, asenna reititin uudelleen sen avulla.

## Internet-kaapelia ei ole liitetty -viesti

Jos Internet-kaapelia ei ole liitetty -viesti tulee näkyviin reitittimen määrittymisen aikana, noudata näitä vianmääritysohjeita:

- Varmista, että Ethernet- tai Internet-kaapeli (tai reitittimen mukana toimitettua kaapelia vastaava kaapeli) on liitetty kunnolla reitittimen takapaneelissa olevaan keltaiseen Internet-porttiin ja kytkettävän modeemin asianmukaiseen porttiin. Tämän portin nimi modeemissa on tavallisesti Ethernet.

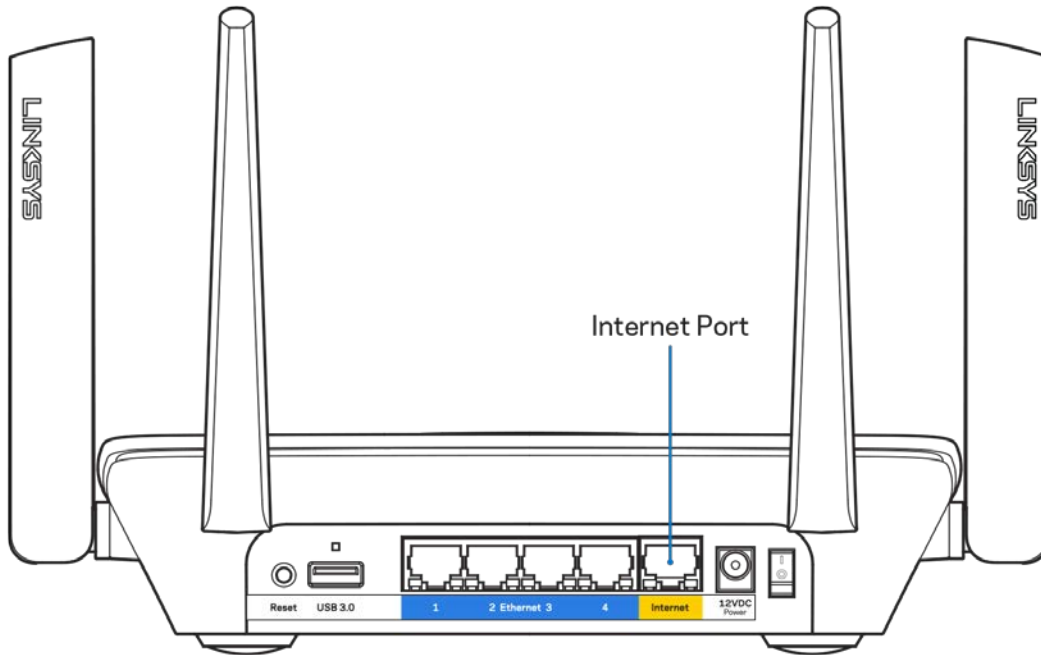

- Varmista, että modeemi on liitetty pistorasiaan ja että virta on kytketty. Jos laitteessa on virtakytkin, varmista, että se on ON- tai I-asennossa (ei O-asennossa).

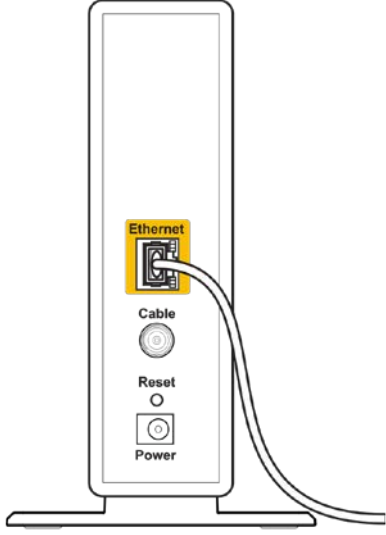
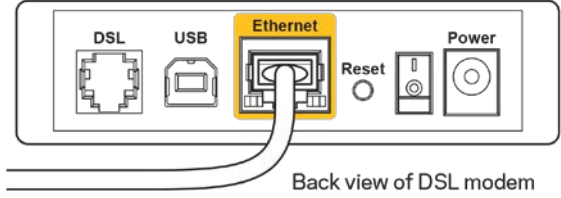

 <p>Back view of cable modem</p>	 <p>Back view of DSL modem</p>
<p>Jos Internet-palvelu toimii kaapeliverkossa, varmista, että kaapelimodeemin CABLE-portti on kytketty Internet-palveluntarjoajan toimittamaan koaksiaalikaapeliin.</p>	<p>Jos Internet-palvelu toimii DSL-verkossa, varmista, että DSL-puhelinjohto on kytketty modeemin DSL-porttiin.</p>

- Jos tietokone on aiemmin kytketty modeemiin USB-kaapelilla, irrota USB-kaapeli.
- Asenna reititin uudelleen.

## ***Reitintä ei voi avata-viesti***

Reitittimen käyttäminen edellyttää yhteyttä omaan verkkoon. Jos käytössä on langaton Internet-yhteys, olet ehkä muodostanut vahingossa yhteyden johonkin toiseen langattomaan verkkoon.

Voit korjata ongelman Windows-tietokoneissa seuraavasti\*:

1. Napsauta työpöydän ilmaisinalueella langattoman yhteyden kuvaketta. Käytävissä olevien verkkojen luettelo avautuu.

2. Napsauta oman verkkosi nimeä. Valitse Yhdistä. Seuraavassa esimerkissä tietokone on liitetty toiseen langattomaan verkkoon, jonka nimi on wraith\_5GHz. Tässä esimerkissä Linksys EA8300 -reitittimen langaton verkko nimeltä Damaged\_Beez2.4 on valittuna.



3. Jos verkko edellyttää verkon suojausavaimen antamista, kirjoita salasana (suojausavain) verkon suojausavaimen kenttään. Valitse **OK**.
4. Tietokone muodostaa yhteyden verkkoon, minkä jälkeen sinun pitäisi voida käyttää reititintä.

*\* Näissä vaiheissa mainittujen toimintojen nimet ja kuvakkeet saattavat vaihdella käytettävän Windows-version mukaan.*

Voit korjata ongelman Mac-tietokoneissa seuraavasti:

1. Napsauta näytön yläreunan valikkorivillä näkyvää Wi-Fi-symbolia. Langattomien verkkojen luettelo tulee näkyviin.
2. Seuraavassa esimerkissä tietokone on liitetty toiseen langattomaan verkkoon, jonka nimi on "wraith\_5GHz". Tässä esimerkissä Linksys EA8300 -reitittimen langaton verkko nimeltä Damaged\_Beez2.4 on valittuna.



3. Valitse Linksys EA8300 -reitittimen langattoman verkon nimi (tässä esimerkissä Damaged\_Beez2.4).
4. Kirjoita langattoman verkon salasana (suojausavain) *Salasana*-kenttään. Valitse **OK**.

## Asennuksen jälkeen

### Internet-yhteys ei ole käytettävissä

Jos Internet-liikenne reitittimen kautta ei toimi, ongelma saattaa ilmetä selaimessa näkyvänä Osoitetta [Internet-osoite] ei löydy -viestinä. Jos tiedät, että Internet-osoite on toimiva, ja olet kokeillut useita kelvollisia Internet-osoitteita samalla tuloksella, viesti saattaa tarkoittaa, että Internet-palveluntarjoajan tai modeemin ja reitittimen välisessä tietoliikenteessä on ongelmia. Kokeile seuraavia ratkaisuja:

- Varmista, että verkko- ja virtakaapelit on kytketty kunnolla.
- Varmista, että pistorasia, johon reititin on kytketty, on toiminnassa.
- Käynnistä reititin uudelleen.
- Ota yhteyttä Internet-palveluntarjoajaan ja selvitä, onko alueellasi käyttökatko.

Vianmääritys kannattaa aloittaa katkaisemalla reitittimen virta ja kytkemällä virta uudelleen. Näin reititin voi ladata omat mukautetut asetuksensa uudelleen, ja muut laitteet (kuten modeemi) voi löytää reitittimen ja muodostaa siihen yhteyden uudelleen. Tätä prosessia kutsutaan uudelleenkäynnistämiseksi.

Käynnistä reititin uudelleen virtajohtojen avulla seuraavasti:

1. Irrota virtajohto reitittimestä ja modeemista.
2. Odota 10 sekuntia ja liitä virtajohto modeemiin uudelleen. Varmista, että laite käynnistyy.
3. Odota, kunnes modeemin online-tilan merkkivalo lakkaa vilkkumasta. (Tämä kestää enintään kaksi minuuttia.) Kytke virtajohto uudelleen reitittimeen.
4. Odota, kunnes Linksys-logovalo syttyy. Odota kaksi minuuttia, ennen kuin yrität muodostaa Internet-yhteyttä tietokoneesta.

Käynnistä reititin uudelleen Linksys Smart Wi-Fi -tilin avulla seuraavasti:

1. Kirjaudu Linksys Smart Wi-Fi -tilille. (Lisätietoja on kohdassa Yhteyden muodostaminen Linksys Smart Wi-Fi -tiliin sivulla [11](#).)
2. Valitse *Router Settings* (Reitittimen asetukset) -kohdassa *Troubleshooting* (Vianmääritys).
3. Napsauta *Diagnostics* (Diagnostiikka) -välilehteä.
4. Valitse *Reboot* (Käynnistä uudelleen) -kohdassa *Reboot* (Käynnistä uudelleen).



5. Valitse **Yes** (Kyllä). Reititin käynnistyy uudelleen. Kun reititin käynnistetään uudelleen, kaikkien liitettyjen laitteiden Internet-yhteys katkeaa. Laitteet yhdistetään uudelleen automaattisesti, kun reititin on käyttövalmis.

## Linksys Smart Wi-Fi ei avaudu selaimen

Linksys Smart Wi-Fi -sivusto toimii uusimmissa Google Chrome<sup>TM</sup>-, Firefox<sup>®</sup>-, Safari<sup>®</sup>- (Mac<sup>®</sup> ja iPad<sup>®</sup>) ja Microsoft Edge -versioissa sekä Internet Explorer<sup>®</sup> 8:ssa ja sitä uudemmissa versioissa.

# Tekniset tiedot

## Linksys EA8300

Mallinimi	Max-Stream AC2200 MU-MIMO kolmitaajuuksinen reititin
Mallinumero	EA8300
Kytkinportin nopeus	10/100/1000 Mbps (Gigabit Ethernet)
Radiotaajuus	2,4 GHz ja 5 GHz (x2)
Antennien määrä	4 ulkoista säädettävää antennia (ei irrotettavissa)
Portit	USB 3.0, Ethernet (1-4), Internet, virta
Painikkeet	Wi-Fi Protected Setup, virtapainike, nollauspainike
Valot	<b>Yläpaneeli:</b> Linksys-logovalo , Wi-Fi Protected Setup, Internet-yhteys, verkkokaapelin yhteys Internet-porttiin <b>Takapaneeli:</b> USB, Ethernet (1-4), Internet
UPnP	Tuettu
Suojausominaisuudet	WEP, WPA2, RADIUS
Suojausavaimen pituus, bittiä	Jopa 128-bittinen salaus
Tallennustilan tietojärjestelmien tuki	FAT, NTFS ja HFS+
Tuetut selaimet	Uusimmat Google Chrome™-, Firefox®-, Safari®- (Mac® ja iPad®) ja Microsoft Edge -versiot sekä Internet Explorer® 8 ja sitä uudemmat versiot

## Käyttöympäristötiedot

Mitat	213,7mm x 161,8mm x 54,8mm (Ilman antennia)
Laitteen paino	608 g
Virta	12 V, 2 A
Sertifioinnit	FCC, IC, CE, Wi-Fi (a/b/g/n/ac)
Käyttölämpötila	0-40 °C
Varastointilämpötila	-20...+60 °C
Käyttöympäristön ilmankosteus	10-80 %, suhteellinen ilmankosteus, kondensoitumaton
Varastointiympäristön ilmankosteus	5-90 %, kondensoitumaton

Oikeus teknisten tietojen muuttamiseen pidätetään.

Huomautukset:

Lisätietoja säännöksistä, takuusta ja turvatiedoista on reitittimen mukana toimitetulla CD-levyllä tai osoitteessa [Linksys.com/support/EA8300](http://Linksys.com/support/EA8300).

Enimmäissuorituskyky IEEE Standard 802.11 -säädöksen mukaan. Todellinen suorituskyky saattaa vaihdella langattoman verkon kapasiteetin, tiedonsiirtonopeuden, alueen ja peiton mukaan.

Suorituskyky riippuu monista tekijöistä, olosuhteista ja muuttujista, mm. etäisyys tukiasemasta, verkkoliikenteen määrä, rakennusmateriaalit ja rakenne, käytössä oleva käyttöjärjestelmä, käytettävien langattomien tuotteiden sekoitus, häiriöt ja muut haitalliset olosuhteet.

BELKIN, LINKSYS ja monet tuotenimet ja logot ovat Belkin-yhtymän omistamia tavaramerkkejä.

Mainitut kolmansien osapuolien tavaramerkit ovat omistajiensa omaisuutta. Tuotteessa käytetyn kolmannen osapuolen ohjelmiston lisenssit ja ilmoitukset ovat saatavilla täällä:

<http://support.linksys.com/en-us/license>. Lisätietoja GPL-lisenssistä ja lähdekoodin pyyntölomake on osoitteessa <http://support.linksys.com/en-us/gplcodecenter>.

© 2017 Belkin International, Inc. ja/tai sen tytäryhtiöt. Kaikki oikeudet pidätetään.

**LINKSYS®**

Guide de l'utilisateur  
**ROUTEUR TRIPLE BANDE  
MU-MIMO MAX-STREAM™  
AC2200**

Modèle n° EA8300

# Table des matières

Présentation du produit.....	3
Vue de dessus.....	3
Indicateur de statut du système.....	4
Vue arrière .....	5
Vue de côté.....	6
Installation : instructions de base .....	7
Où trouver une aide supplémentaire .....	7
Comment installer votre routeur .....	8
Comment utiliser l'appli Linksys Smart Wi-Fi .....	11
Comment se connecter à Linksys Smart Wi-Fi.....	11
Network Map (Plan du réseau) .....	12
Guest Access (Accès Invité) .....	12
Parental Controls (Contrôle parental).....	13
Media Priorization (Gestion de la priorité des médias).....	13
Speed Test (Test de vitesse) .....	14
External Storage (Stockage externe).....	14
Connectivity (Connectivité) .....	15
Troubleshooting (Dépannage).....	15
Wireless (Sans fil).....	16
Security (Sécurité) .....	16
Dépannage .....	17
La configuration de votre routeur a échoué.....	17
Message de type <i>Votre câble Internet n'est pas branché</i> .....	18
Message de type <i>Impossible d'accéder à votre routeur</i> .....	19
Après la configuration.....	21
Internet semble inaccessible.....	21
L'interface Linksys Smart Wi-Fi ne s'ouvre pas dans votre navigateur Web .....	22
Spécifications .....	23
Linksys EA8300 .....	23
Conditions environnementales.....	23



# Présentation du produit

## Vue de dessus

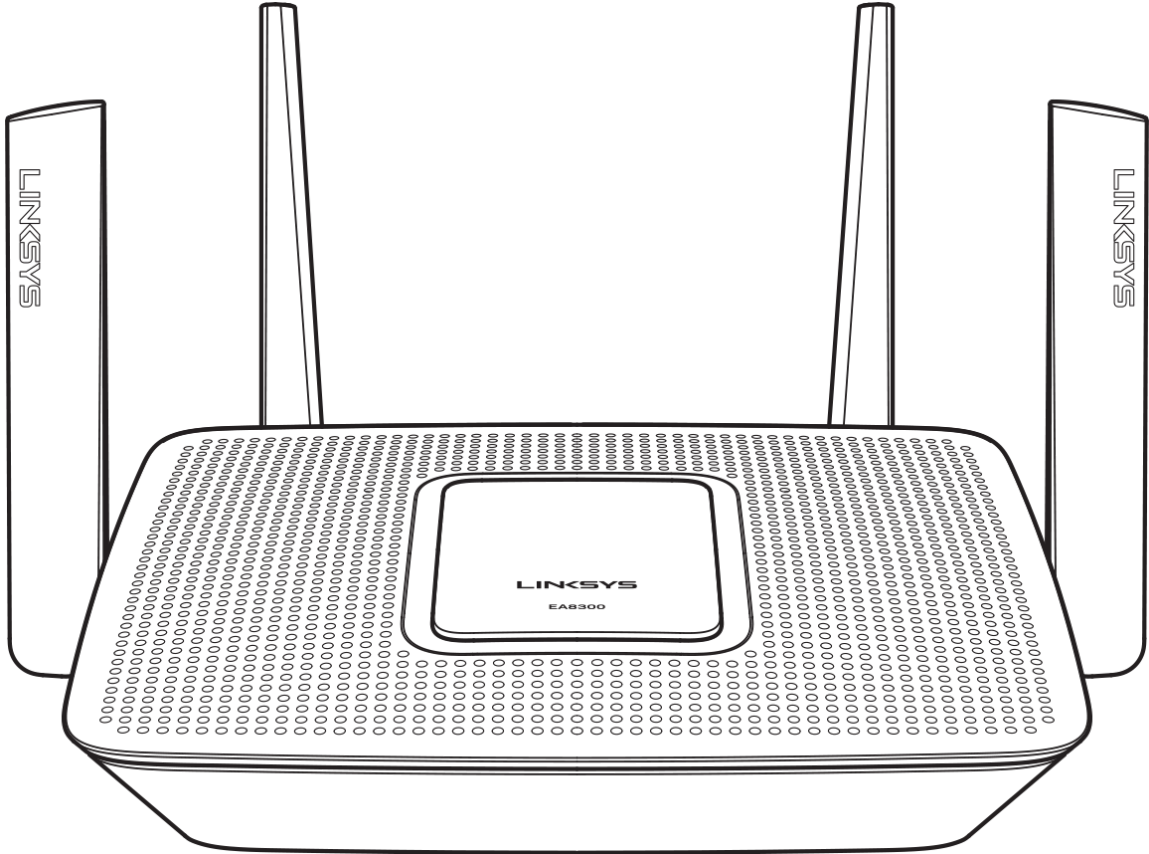

## Indicateur de statut du système

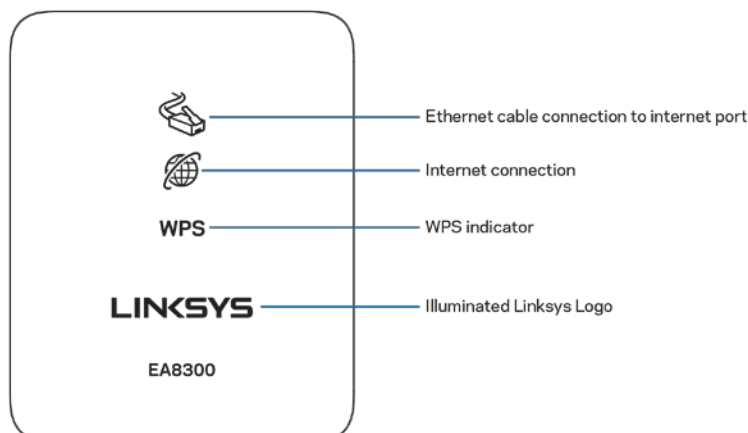

Branchement du câble Ethernet sur le port Internet : si ce voyant est allumé (en orange), cela signifie qu'un problème est survenu au niveau du branchement du câble réseau sur le port Internet (WAN) du routeur.

Connexion Internet : si ce voyant est allumé (en orange), cela signifie que le routeur ne parvient pas à se connecter à Internet.

WPS (Wi-Fi Protected Setup™) : ce voyant dispose de 4 codes couleurs différents.

<b>Voyant désactivé</b>	Aucune activité Wi-Fi Protected Setup
<b>Voyant blanc clignotant</b>	Wi-Fi Protected Setup en cours d'activation
<b>Voyant blanc restant allumé</b>	Wi-Fi Protected Setup en cours d'activité (voyant restant allumé pendant 5 secondes)
<b>Voyant orange clignotant</b>	Wi-Fi Protected Setup rencontrant un problème (voyant clignotant pendant 1 minute avant de s'éteindre)

Logo Linksys lumineux : voyant clignotant pendant le démarrage du routeur. Lorsque le voyant reste allumé en blanc, cela signifie que le routeur fonctionne correctement.

## Vue arrière

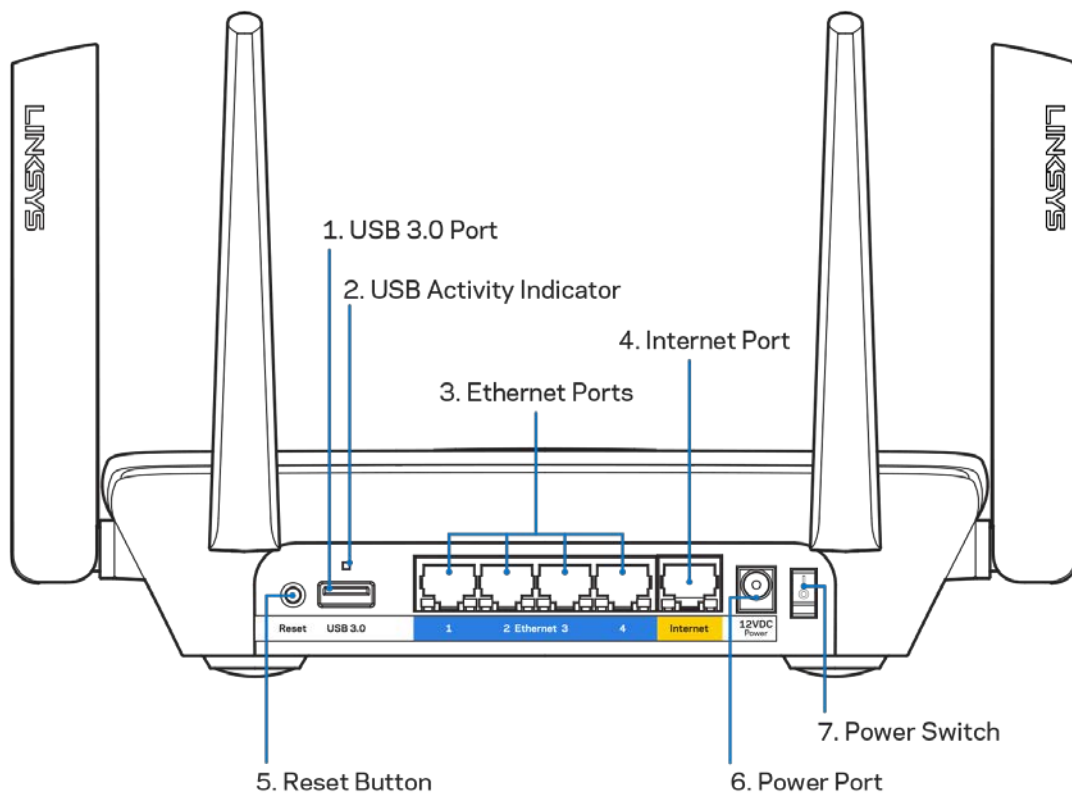

**Ports USB 3.0 (1) :** branchez des clés USB ou autres périphériques USB pour les partager sur le réseau ou les connecter à Internet.

**Témoin lumineux pour port USB (2) :** ces voyants indiquent le transfert de données depuis / vers les appareils externes.

**Ports Ethernet (3) :** branchez l'une des deux extrémités du câble Ethernet sur un de ces ports Gigabit (10/100/1000) bleus et l'autre extrémité sur le périphérique filaire que vous souhaitez connecter au réseau.

*Remarque : Pour des performances optimales, branchez des câbles de catégorie CAT5e (ou catégorie supérieure) sur les ports Ethernet.*

**Port Internet (4) :** branchez l'une des deux extrémités du câble Ethernet sur ce port Gigabit (10/100/1000) jaune et l'autre extrémité sur le port du modem haut débit / DSL ou fibre optique.

*Remarque : Pour des performances optimales, branchez un câble de catégorie CAT5e (ou catégorie supérieure) sur le port Internet.*

**Bouton de réinitialisation (5) :** pour restaurer les paramètres d'usine du routeur, maintenez ce bouton enfoncé jusqu'à ce que le logo Linksys s'éteigne. Vous pouvez également restaurer les paramètres d'usine à l'aide de Linksys Smart Wi-Fi via Internet ou l'application mobile.

**Port d'alimentation (6) :** Branchez sur ce port l'adaptateur secteur fourni avec le routeur.

**Bouton d'alimentation (7) :** Appuyez sur | pour allumer (on) le routeur.

## Vue de côté

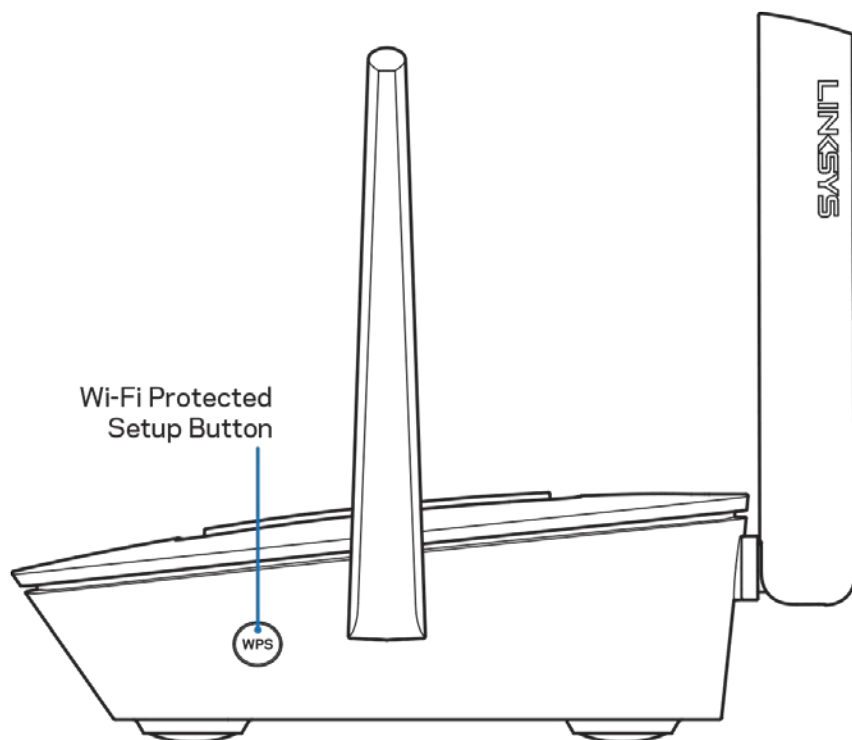

**Bouton Wi-Fi Protected Setup™** : appuyez sur ce bouton pour connecter les périphériques réseau compatibles WPS.

# Installation : instructions de base

## Où trouver une aide supplémentaire

En plus de ce guide de l'utilisateur, vous pouvez trouver de l'aide supplémentaire ici :

- [Linksys.com/support/EA8300](http://Linksys.com/support/EA8300) (documentation, téléchargements, FAQ, assistance technique, chat en direct, forums)
- Assistance Linksys Smart Wi-Fi (connectez-vous à votre compte Linksys Smart Wi-Fi, puis cliquez sur Aide en haut de l'écran)

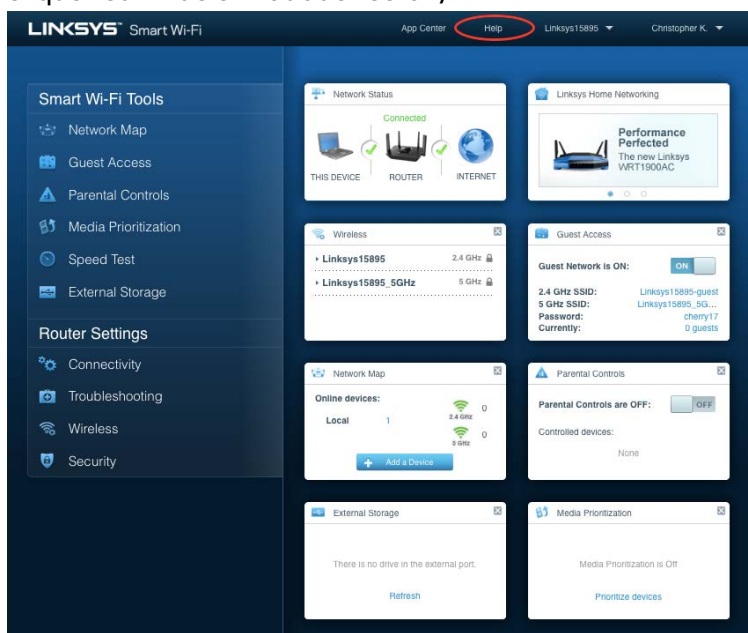

The screenshot shows the Linksys Smart Wi-Fi web interface. The top navigation bar includes 'App Center', 'Help' (circled in red), 'Linksys15895', and 'Christopher K.'. The main content area is divided into several sections: 'Smart Wi-Fi Tools' (Network Map, Guest Access, Parental Controls, Media Prioritization, Speed Test, External Storage), 'Router Settings' (Connectivity, Troubleshooting, Wireless, Security), and various status widgets (Network Status, Linksys Home Networking, Wireless, Guest Access, Network Map, Parental Controls, External Storage, Media Prioritization).

## Help

### Using Linksys Smart Wi-Fi

Linksys Smart Wi-Fi allows you to access all of your router's features and settings. Simply click on a feature or widget you want to open.

You can use Linksys Smart Wi-Fi to:

- See what's currently connected to your network, and connect more computers and devices.
- Create a Linksys Smart Wi-Fi account to access router settings from anywhere using any browser, even when you're away from home. You can personalize your router and change settings for wireless access, Internet, gaming, local network, and more. You can even access router settings for multiple routers, which is helpful if you set up and manage more than one router. (The account is available only on EA-Series routers.)
- Allow guests in your home to use the Internet without giving them access to your network. While on the guest network, users can surf the net, but won't be able to access your printers, other computers, or devices on your network.

#### Help Categories

- Linksys Smart Wi-Fi
- Device List
- Guest Access
- Parental Controls
- Media Prioritization
- Speed Test
- External Storage
- Connectivity

Ok

Remarque : Les licences et les notices relatives aux logiciels tiers utilisés dans ce produit sont disponibles à l'adresse suivante : <http://support.linksys.com/en-us/license> Veuillez vous rendre sur la page Web <http://support.linksys.com/en-us/gplcodecenter> pour toute demande relative au code source GPL.

## Comment installer votre routeur

1. Pour terminer l'installation, rendez-vous sur le site Web suivant : <http://LinksysSmartWiFi.com>.
2. Identifiez votre type d'installation.

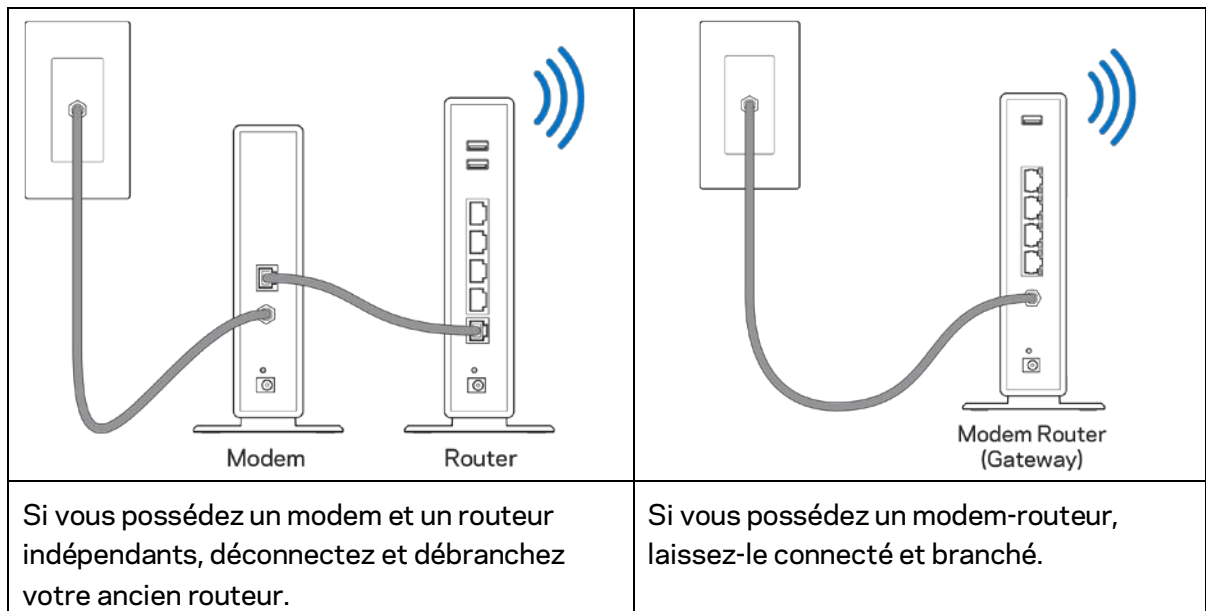

3. Positionnez les antennes à la verticale et branchez le routeur sur une prise de courant. Assurez-vous que l'interrupteur d'alimentation est sur | (on).
4. Branchez votre routeur à votre modem ou modem routeur. Connectez une extrémité du câble Internet fourni au port Internet jaune de votre nouveau routeur. Si vous possédez un modem, branchez l'autre extrémité sur le port Ethernet (LAN) de votre modem. Si vous avez un modem routeur, branchez l'autre extrémité du câble sur n'importe quel port disponible.
5. Patientez jusqu'à ce que le logo Linksys sur le dessus du routeur cesse de clignoter et reste allumé en blanc.
6. Connectez-vous au réseau Wi-Fi portant le nom indiqué dans le Guide de démarrage rapide fourni avec votre routeur (vous pourrez changer ces informations plus tard). Si vous avez besoin d'aide pour vous connecter au réseau, reportez-vous à la documentation disponible sur [linksys.com/support/ea8300](http://linksys.com/support/ea8300).

Remarque : Vous n'aurez pas accès à Internet tant que l'installation n'est pas terminée.

7. Saisissez <http://LinksysSmartWiFi.com> dans la barre d'adresse de votre navigateur Web. Suivez les instructions à l'écran pour terminer la configuration. Vous pouvez également taper 192.168.1.1 dans votre navigateur pour démarrer l'installation.

À la fin de l'installation, suivez les instructions à l'écran pour configurer votre compte Linksys Smart Wi-Fi. Utilisez Linksys Smart Wi-Fi pour configurer votre routeur depuis n'importe quel ordinateur disposant d'une connexion Internet.

Et gérez les paramètres de votre routeur :

- Modifiez le nom du routeur et le mot de passe
- Configurez un accès Invité
- Paramétrez le contrôle parental
- Connectez des périphériques à votre Wi-Fi
- Testez la vitesse de votre connexion Internet

**Remarque :** Lors de la configuration de votre compte Linksys Smart Wi-Fi, un e-mail de vérification vous sera envoyé. À partir de votre réseau domestique, cliquez sur le lien inclus dans l'e-mail pour associer votre routeur au compte Linksys Smart Wi-Fi.

**Astuce :** Cliquez sur *Page suivante* dans votre navigateur, imprimez la page qui s'affiche, puis notez dans le tableau ci-dessous les paramètres de votre routeur et de votre compte. Conservez-les en lieu sûr.

Nom du Wi-Fi 2,4 GHz	
Mot de passe du réseau Wi-Fi	
Nom du Wi-Fi 5 GHz <sub>1</sub>	
Mot de passe du réseau Wi-Fi	
Nom du Wi-Fi 5 GHz <sub>2</sub>	
Mot de passe du réseau Wi-Fi	
Mot de passe du routeur	
Nom du Wi-Fi invité 2,4 GHz	
Nom du Wi-Fi invité 5GHz	
Mot de passe du Wi-Fi invité (les deux réseaux partagent le même mot de passe)	
Nom d'utilisateur du compte Linksys Smart Wi-Fi	
Mot de passe Linksys Smart Wi-Fi	



# Comment utiliser l'appli Linksys Smart Wi-Fi

Vous pouvez configurer votre routeur n'importe où dans le monde grâce à Linksys Smart Wi-Fi, mais vous avez également la possibilité de le configurer directement à partir de votre réseau domestique. Il se peut que Linksys Smart Wi-Fi soit également disponible pour votre appareil mobile. Pour en savoir plus à ce sujet, consultez la boutique d'applications de votre appareil.

## Comment se connecter à Linksys Smart Wi-Fi

Pour vous connecter à Linksys Smart Wi-Fi :

1. Ouvrez le navigateur Web de votre ordinateur.
2. Rendez-vous sur <http://LinksysSmartWiFi.com> et connectez-vous à votre compte.

Linksys Smart Wi-Fi Sign In

If you have not yet created a Linksys Smart Wi-Fi account, click the "Create Account" button in the upper right corner of the page.

Give guests Internet access

Use your Linksys Smart Wi-Fi account to access your home network from anywhere, at any time, even from your mobile device. Easily connect new devices, set parental controls, get access to Smart Wi-Fi mobile Apps, and more.

For more information [click here](#)

English (United States)

For local access, [click here](#).

Si vous avez oublié votre mot de passe, cliquez sur *Vous avez oublié votre mot de passe ?* et suivez les instructions à l'écran pour le récupérer.

## Network Map (Plan du réseau)

Carte du réseau vous permet d'afficher et de gérer tous les périphériques réseau connectés à votre routeur. Vous pouvez ainsi voir quels sont les périphériques connectés à votre réseau principal et votre réseau invité ou afficher les informations pour chacun des périphériques.



## Guest Access (Accès Invité)

Accès Invité vous permet de créer et contrôler un réseau Wi-Fi uniquement accessible à vos invités tout en protégeant vos données personnelles.

The screenshot shows the 'Guest Access' configuration interface. At the top, there is a title 'Guest Access' and a checkbox 'Show widget on the homepage' which is checked. Below the title, there is a subtitle 'Guest access allows visitors to connect to your wireless guest network and access the Internet, without giving access to your other computers or personal data.' The main area is divided into several sections: 'Allow guest access' with a toggle switch set to 'ON'; 'Guest network names and password' with an 'Edit' link; '2.4 GHz SSID' with 'parlor2.4' and 'Network: Enabled'; '5 GHz SSID' with 'parlor5' and 'Network: Enabled'; 'Guest network password' with 'they'; and 'Total guests allowed' with a dropdown menu set to '5 guests'. A warning box with an exclamation mark icon contains the text: 'Your guest should first connect to your guest network, open a web browser, and then enter the guest password.' At the bottom, there are 'OK' and 'Cancel' buttons.

## Parental Controls (Contrôle parental)

Contrôle parental vous permet de bloquer des sites Web et de limiter l'accès Internet à certaines heures.

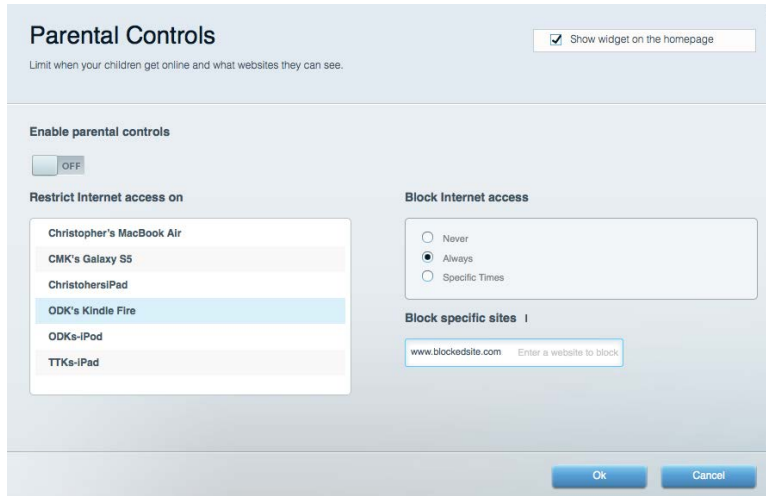

## Media Priorization (Gestion de la priorité des médias)

Gestion de la priorité des médias vous permet de définir les dispositifs et les applications qui ont une priorité absolue pour le trafic de votre réseau.

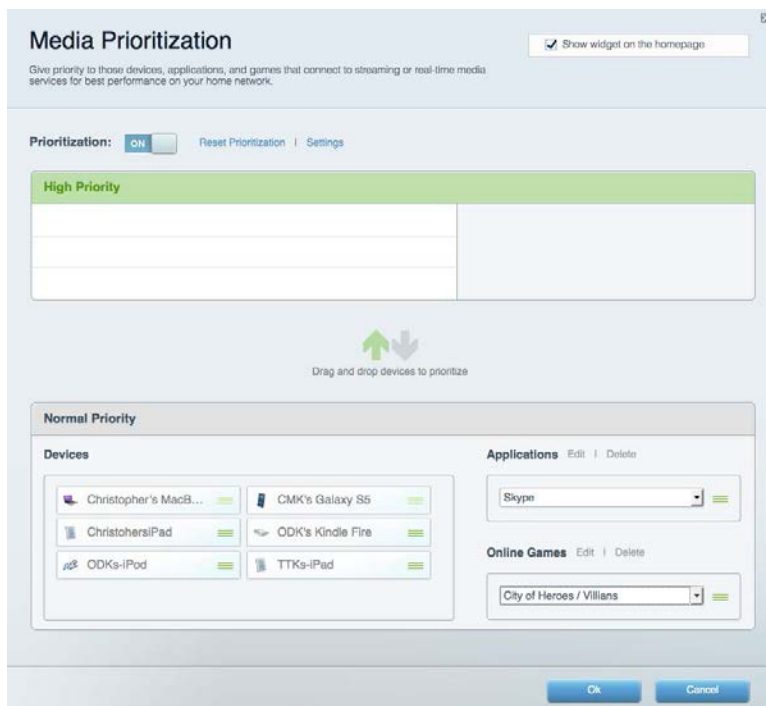

## Speed Test (Test de vitesse)

Test de vitesse vous permet de tester la vitesse de connexion Internet de votre réseau.



## External Storage (Stockage externe)

Stockage externe vous permet d'accéder à une clé USB (non fournie) et de mettre en place le partage de fichiers, un serveur de médias et l'accès à un FTP.

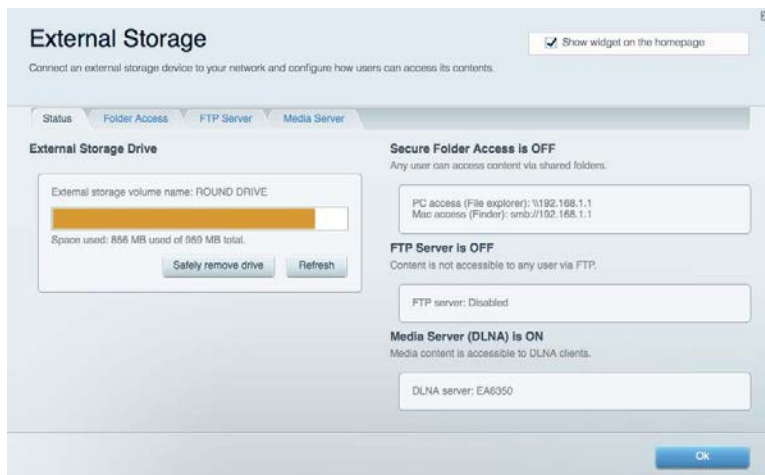

## Connectivity (Connectivité)

Connectivité vous permet de configurer les paramètres réseau de base et avancées.

The screenshot shows the 'Connectivity' settings page. It has a title bar with a close button. Below the title is a subtitle 'View and change router settings'. There are several tabs: 'Basic', 'Internet Settings', 'Local Network', 'Advanced Routing', 'VLAN', and 'Administration'. The 'Basic' tab is selected. The page is divided into several sections: 'Network Name and Password' with fields for 2.4 GHz and 5 GHz network names and passwords; 'Router Password' with a masked password field; 'Router Firmware Update' with a checked 'Automatic' option and a 'Check for Updates' button; 'Time Zone' with a dropdown menu set to '(GMT-05:00) Eastern Time (USA & Canada)' and a checked 'Automatically adjust for Daylight Savings Time' option; and 'Activity Lights' with an 'ON' toggle and a text box explaining the power light status. At the bottom, there are 'Ok', 'Cancel', and 'Apply' buttons.

## Troubleshooting (Dépannage)

Dépannage vous offre un diagnostic des problèmes rencontrés avec votre routeur et vérifie le statut de votre réseau.

The screenshot shows the 'Troubleshooting' page. It has a title bar with a close button. Below the title is a subtitle 'Troubleshoot router settings'. There are three tabs: 'Status', 'Diagnostics', and 'Logs'. The 'Diagnostics' tab is selected. The page is divided into several sections: 'Ping IPv4' with input fields for IP or host name and number to ping, and a 'Start to Ping' button; 'Trace route' with an input field for IP or host name and a 'Start to Traceroute' button; 'Reboot' with a 'Reboot the router' link; 'Router configuration' with 'Backup' and 'Restore' buttons; 'Router Firmware' with a 'Restore previous firmware' button; 'Internet Address:' showing IPv4 (10.0.0.253) and IPv6 (2601:0540::000:0019:0000:0000:0000:314e) addresses with 'Release and Renew' links; and 'Factory reset' with a 'Reset to factory default settings' link. At the bottom, there is an 'Ok' button.

## Wireless (Sans fil)

Sans fil vous permet de configurer le réseau sans fil /Wi-Fi de votre routeur. Les paramètres que vous pouvez modifier ici comprennent le nom du réseau, le mode de sécurité, le mot de passe, le filtrage MAC et la connexion de périphériques via Wi-Fi Protected Setup.

The screenshot shows the 'Wireless' configuration page. At the top, there is a checkbox for 'Show widget on the homepage' which is checked. Below this, there are tabs for 'Wireless', 'MAC Filtering', and 'Wi-Fi Protected Setup'. The 'Smart Connect' section has two radio buttons: '5 GHz band steering' (selected) and 'Off'. Below this, there are two network configuration sections. The first section is for the 2.4 GHz network, with the name 'arachnid', password 'peterparker', and security mode 'WPA2/WPA Mixed'. The second section is for the 5 GHz network, with the name 'arachnid\_5GHz', password 'peterparker', and security mode 'WPA2/WPA Mixed'. At the bottom, there are 'Ok', 'Cancel', and 'Apply' buttons.

## Security (Sécurité)

Sécurité vous permet de configurer la sécurité du réseau sans fil de votre routeur. Vous pouvez configurer le pare-feu et les paramètres VPN, et personnaliser les options de vos applications et de vos jeux.

The screenshot shows the 'Security' configuration page. At the top, there are tabs for 'Firewall', 'DMZ', and 'Apps and Gaming'. The 'Firewall' section has two checkboxes for 'IPv4 SPI firewall protection' and 'IPv6 SPI firewall protection', both of which are checked. The 'VPN Passthrough' section has three checkboxes for 'IPSec Passthrough', 'PPTP Passthrough', and 'L2TP Passthrough', all of which are checked. The 'Internet filters' section has four checkboxes: 'Filter anonymous Internet requests' (checked), 'Filter multicast' (unchecked), 'Filter Internet NAT redirection' (unchecked), and 'Filter ident (Port 113)' (checked). At the bottom, there is a table for 'IPv6 Port Services' with columns for 'Description', 'Protocol', 'IPv6 Address', 'Allow', and 'Enabled'. Below the table is a button labeled 'Add IPv6 Firewall Setting'. At the bottom of the page, there are 'Ok', 'Cancel', and 'Apply' buttons.

# Dépannage

Pour obtenir de l'aide, contactez notre service d'assistance technique primé à l'adresse suivante : [Linksys.com/support/ea8300](https://Linksys.com/support/ea8300).

## La configuration de votre routeur a échoué

Si Linksys Smart Wi-Fi n'a pas terminé l'installation, vous pouvez opter pour l'une des solutions suivantes :

- Au moyen d'un trombone ou d'une épingle, appuyez et maintenez enfoncé le bouton de réinitialisation de votre routeur jusqu'à ce que le logo de la marque Linksys s'éteigne et que les indicateurs MU-MIMO clignotent (environ 10 secondes). Installez à nouveau le routeur.

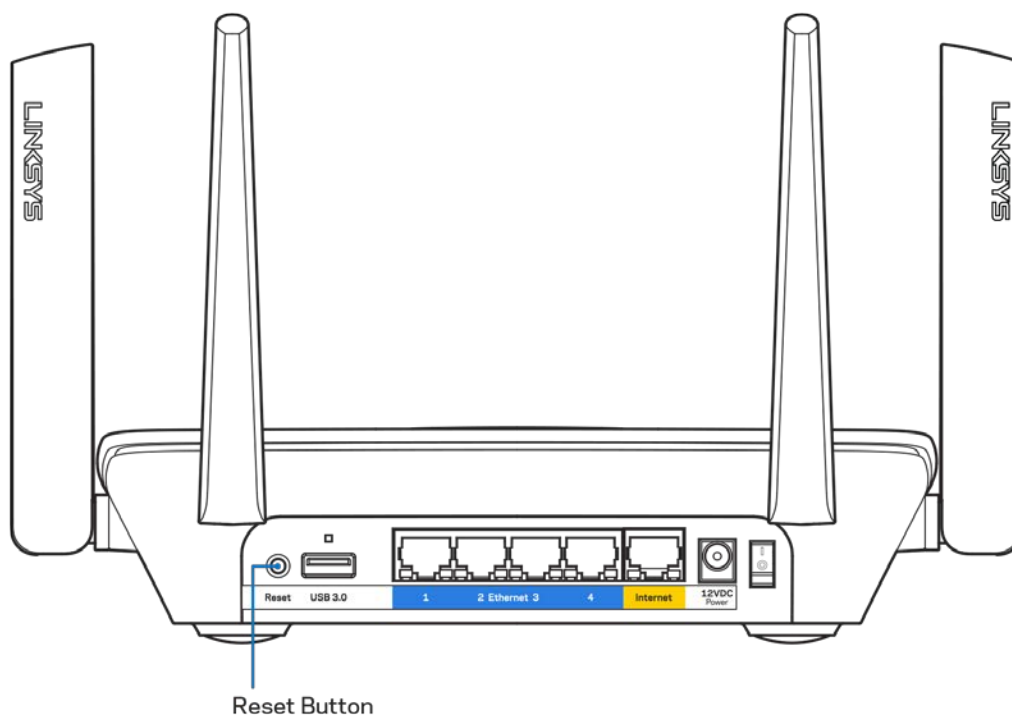

- Désactivez temporairement le pare-feu de votre ordinateur (voir les instructions du logiciel de sécurité pour obtenir de l'aide à ce sujet). Installez à nouveau le routeur.
- Si vous avez un autre ordinateur, utilisez-le pour installer à nouveau le routeur.

## Message de type *Votre câble Internet n'est pas branché*

Si vous obtenez un message « Votre câble Internet n'est pas branché » lorsque vous essayez de configurer votre routeur, procédez comme suit :

- Assurez-vous qu'un câble Ethernet ou Internet (ou un câble identique à celui fourni avec votre routeur) est correctement connecté entre le port jaune Internet à l'arrière du routeur et le port approprié de votre modem. Ce port est généralement étiqueté « Ethernet » sur le modem.

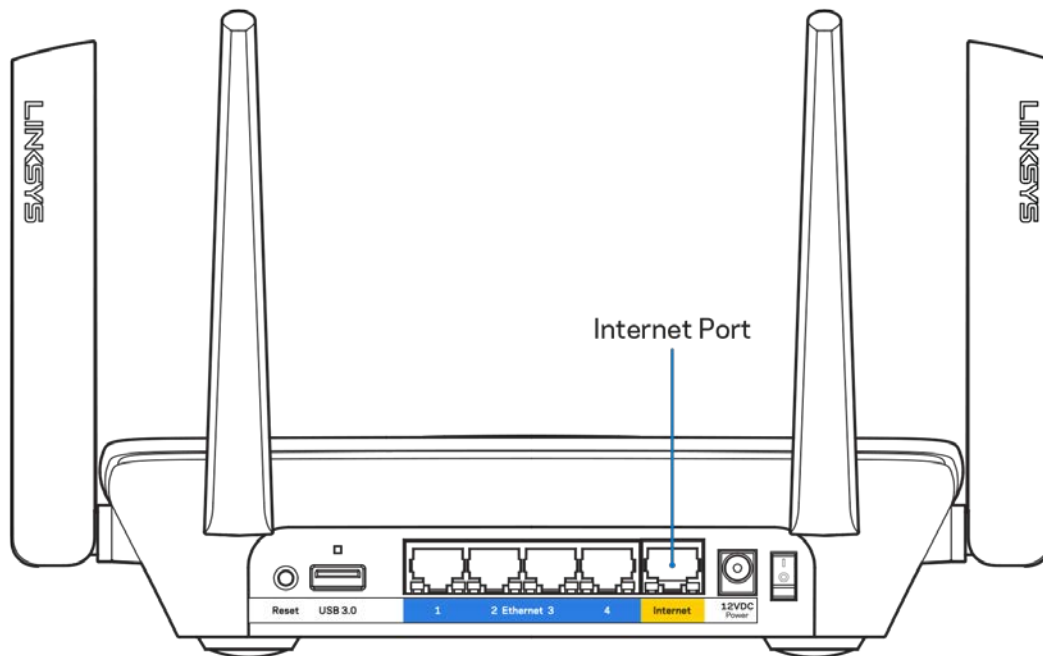

- Assurez-vous que votre modem est connecté à la source d'alimentation et allumé. S'il possède un interrupteur d'alimentation, assurez-vous qu'il est en position « ON » ou « I » (plutôt que O).

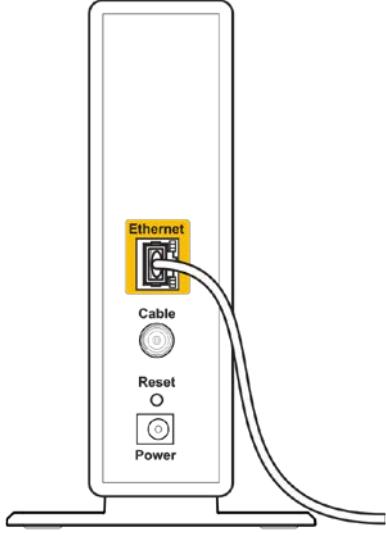
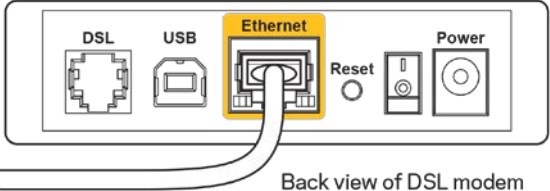

 <p style="text-align: center;">Back view of cable modem</p>	 <p style="text-align: center;">Back view of DSL modem</p>
<p>Si votre service Internet est de type câble, assurez-vous que le port CABLE du modem câble est raccordé au câble coaxial fourni par votre FAI.</p>	<p>Si votre service Internet est de type DSL, assurez-vous que la ligne téléphonique DSL est raccordée au port DSL du modem.</p>

- Si votre ordinateur a déjà été connecté à votre modem avec un câble USB, débranchez le câble USB.
- Installez à nouveau le routeur.

## Message de type *Impossible d'accéder à votre routeur*

Vous devez être connecté à votre réseau pour accéder à votre routeur. Si vous disposez d'un accès sans fil à Internet, assurez-vous d'être bien connecté à votre réseau et de n'avoir commis aucune erreur.

Pour résoudre ce problème sur un ordinateur Windows, procédez comme suit\* :

1. Cliquez sur l'icône de réseau sans fil situé sur le Bureau Windows, dans la barre d'état système de l'ordinateur. La liste des réseaux disponibles s'affiche.

2. Cliquez sur le nom de votre réseau. Cliquez ensuite sur Connect (Connexion). Dans l'exemple ci-dessous, l'ordinateur est connecté à un réseau sans fil nommé *wraith\_5GHz*. Le nom du réseau sans fil du routeur Linksys EA8300, à savoir *Damaged\_Beez2.4* dans notre exemple, est affiché en surbrillance.



3. Si vous êtes invité à entrer une clé réseau, saisissez votre mot de passe (Security Key) dans les champs *Network key* (Clé réseau) et *Confirm network key* (Confirmer la clé réseau). Cliquez sur **OK**.
4. Votre ordinateur se connectera au réseau et vous devriez être en mesure d'accéder au routeur.

*\* Selon la version de Windows que vous utilisez, il se peut que les termes ou les icônes affichés soient différents de ce qui est indiqué dans ces instructions.*

Pour résoudre le problème sur les ordinateurs Mac, procédez comme suit :

1. Dans la barre de menus située en haut de l'écran, cliquez sur l'icône Wi-Fi. La liste des réseaux sans fil s'affiche.

2. Dans l'exemple ci-dessous, l'ordinateur est connecté à un réseau sans fil nommé « *wraith\_5GHz* ». Le nom du réseau sans fil du routeur Linksys EA8300, à savoir *Damaged\_Beez2.4* dans notre exemple, est affiché en surbrillance.

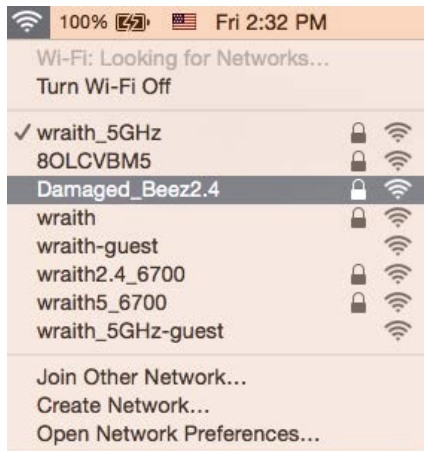

3. Cliquez sur le nom du réseau sans fil de votre routeur Linksys EA8300 (*Damaged\_Beez2.4* dans cet exemple).
4. Saisissez le mot de passe (clé de sécurité) de votre réseau sans fil dans le champ *Password* (Mot de passe). Cliquez sur **OK**.

## Après la configuration

### Internet semble inaccessible

Si votre routeur ne parvient pas à communiquer avec Internet, cela peut se traduire par l'apparition d'un message de type « Impossible d'ouvrir [adresse Internet] » dans votre navigateur Web. Si vous êtes sûr que l'adresse Internet est correcte et que vous avez essayé plusieurs autres adresses Internet valides en obtenant le même résultat, il se peut qu'il y ait un problème de communication entre votre routeur et votre FAI ou votre modem. Essayez la solution suivante :

- Assurez-vous que tous vos câbles réseau et vos câbles d'alimentation sont correctement branchés.
- Assurez-vous que la prise électrique sur laquelle votre routeur est branché est sous tension.
- Redémarrez votre routeur.
- Prenez contact avec votre FAI pour savoir s'il y a eu des pannes de courant dans votre quartier.

La méthode la plus courante pour dépanner votre routeur consiste à l'éteindre puis à le rallumer. Cela lui permet alors de recharger ses paramètres personnalisés afin que les autres périphériques (tels que le modem) puissent le détecter à nouveau et communiquer avec lui. Ce processus est appelé « redémarrage ».

Pour redémarrer votre routeur à l'aide du cordon d'alimentation :

1. Débranchez le cordon d'alimentation du routeur et du modem.

2. Attendez dix secondes, puis rebranchez le cordon d'alimentation sur le modem. Assurez-vous qu'il est bien sous tension.
3. Attendez que le voyant « en ligne » du modem s'arrête de clignoter (environ deux minutes). Rebranchez le cordon d'alimentation sur le routeur.
4. Le logo de la marque Linksys s'allume. Patientez deux minutes avant d'essayer de vous connecter à Internet à partir d'un ordinateur.

Pour redémarrer votre routeur à l'aide de Linksys Smart Wi-Fi :

1. Connectez-vous à Linksys Smart Wi-Fi (cf. « Comment se connecter à Linksys Smart Wi-Fi » à la page [11](#)).
2. Sous *Router Settings* (Paramètres du routeur), cliquez sur *Troubleshooting* (Dépannage).
3. Cliquez sur l'onglet *Diagnostics* (Diagnostic).
4. Sous *Reboot* (Redémarrage), cliquez sur *Reboot* (Redémarrer).



5. Cliquez sur **Yes** (Oui). Le routeur redémarre. Pendant le redémarrage du routeur, tous les périphériques connectés perdront leur connexion Internet et se reconnecteront automatiquement une fois que le routeur sera à nouveau prêt.

## L'interface Linksys Smart Wi-Fi ne s'ouvre pas dans votre navigateur Web

Linksys Smart Wi-Fi est compatible avec les dernières versions de Google Chrome™, Firefox®, Safari® (Mac® et iPad®), Microsoft Edge ainsi que la version 8 d'Internet Explorer®.

# Spécifications

## Linksys EA8300

Nom du modèle	Routeur Gigabit Triple bande MU-MIMO Max-Stream™ AC2200
Référence du modèle	EA8300
Vitesse des ports	10/100/1000 Mbit/s (Gigabit Ethernet)
Fréquence radio	2,4 GHz et 5 GHz (x2)
Nombre d'antennes	4 antennes externes (non amovibles)
Ports	USB 3.0, Ethernet (1-4), Internet, alimentation
Boutons	Wi-Fi Protected Setup, alimentation, réinitialisation
Voyants	<b>Panneau supérieur</b> : Logo Linksys lumineux, Wi-Fi Protected Setup, connexion Internet, Branchement du câble réseau sur le port Internet <b>Panneau arrière</b> : USB, Ethernet (1-4), Internet
UPnP	Compatible
Fonctions de sécurité	WEP, WPA2, RADIUS
Configuration binaire de la clé de sécurité	Cryptage jusqu'à 128 bits
Systèmes de fichiers pris en charge	FAT, NTFS et HFS+
Navigateurs pris en charge	Les dernières versions de Google Chrome™, Firefox®, Safari® (Mac® et iPad®), Microsoft Edge ainsi que la version 8 (et versions ultérieures) d'Internet Explorer®

## Conditions environnementales

Dimensions	213,7 mm x 161,8 mm x 54,8 mm (sans les antennes)
Poids de l'unité	608 g
Alimentation	12 V, 2 A
Certifications	FCC, IC, CE, Wi-Fi (a/b/g/n/ac)
Température de fonctionnement	0 à 40 °C
Températures de stockage	-20 °C à 60 °C
Humidité en fonctionnement	10 % à 80 % d'humidité relative non condensée
Humidité de stockage	5 % à 90 %, sans condensation

Ces spécifications sont sujettes à modification sans préavis.

Remarques :

Pour plus d'informations sur les réglementations, la garantie et la sécurité, consultez le CD fourni avec votre routeur ou rendez-vous sur [Linksys.com/support/EA8300](http://Linksys.com/support/EA8300).

Les performances maximales sont conformes à la norme IEEE 802.11. Les performances réelles peuvent varier, notamment la capacité du réseau sans fil, le débit de données, la portée et la couverture. Les performances résultent de plusieurs facteurs, conditions et variables, tels que la distance du point d'accès, le volume du trafic réseau, les matériaux de construction, le système d'exploitation utilisé, les produits sans fil utilisés et les interférences.

BELKIN, LINKSYS et de nombreux autres noms et logos de produit sont des marques commerciales du groupe de sociétés Belkin. Les marques de tiers mentionnées ici appartiennent à leurs propriétaires respectifs. Les licences et les notices relatives aux logiciels tiers utilisés dans ce produit sont disponibles à l'adresse suivante : <http://support.linksys.com/en-us/license>. Veuillez contacter <http://support.linksys.com/fr-eu/gplcodecenter> pour toute question ou toute demande de code source GPL.

© 2017 Belkin International, Inc. et/ou ses filiales. Tous droits réservés.

**LINKSYS®**

Felhasználói kézikönyv

**MAX-STREAM™  
AC2200 MU-MIMO  
HÁROMSÁVOS ROUTER**

EA8300 modell

# Tartalom

<b>Termék-összefoglaló .....</b>	<b>3</b>
Felülnézet.....	3
A rendszer állapotjelzője .....	4
Hátulnézet.....	5
Oldalnézet.....	6
<b>Beállítás: Alapok .....</b>	<b>7</b>
Hol találok további segítséget.....	7
A router telepítése .....	8
<b>A Linksys Smart Wi-Fi használata .....</b>	<b>11</b>
Csatlakozás a Linksys Smart Wi-Fi szolgáltatáshoz .....	11
Hálózati térkép.....	12
Vendég hozzáférés .....	12
Szülői felügyelet .....	13
Média rangsorolás.....	13
Sebességteszt.....	14
Külső tárhely .....	14
Csatlakoztathatóság.....	15
Hibaelhárítás .....	15
Vezeték nélküli kapcsolat.....	16
Biztonság.....	16
<b>Hibaelhárítás .....</b>	<b>17</b>
A router telepítése nem sikerült.....	17
<i>Your Internet cable is not plugged in</i> (Az internetkábel nincs csatlakoztatva) üzenet.....	18
<i>Cannot access your router</i> (Az útválasztó nem érhető el) üzenet.....	19
A telepítés után.....	21
Úgy tűnik nem érhető el az internet.....	21
A Linksys Smart Wi-Fi nem nyílik meg a webböngészőben .....	22
<b>Műszaki adatok.....</b>	<b>23</b>
Linksys EA8300 .....	23
Beépítési adatok.....	23



# Termék-összefoglaló

## Felülnézet

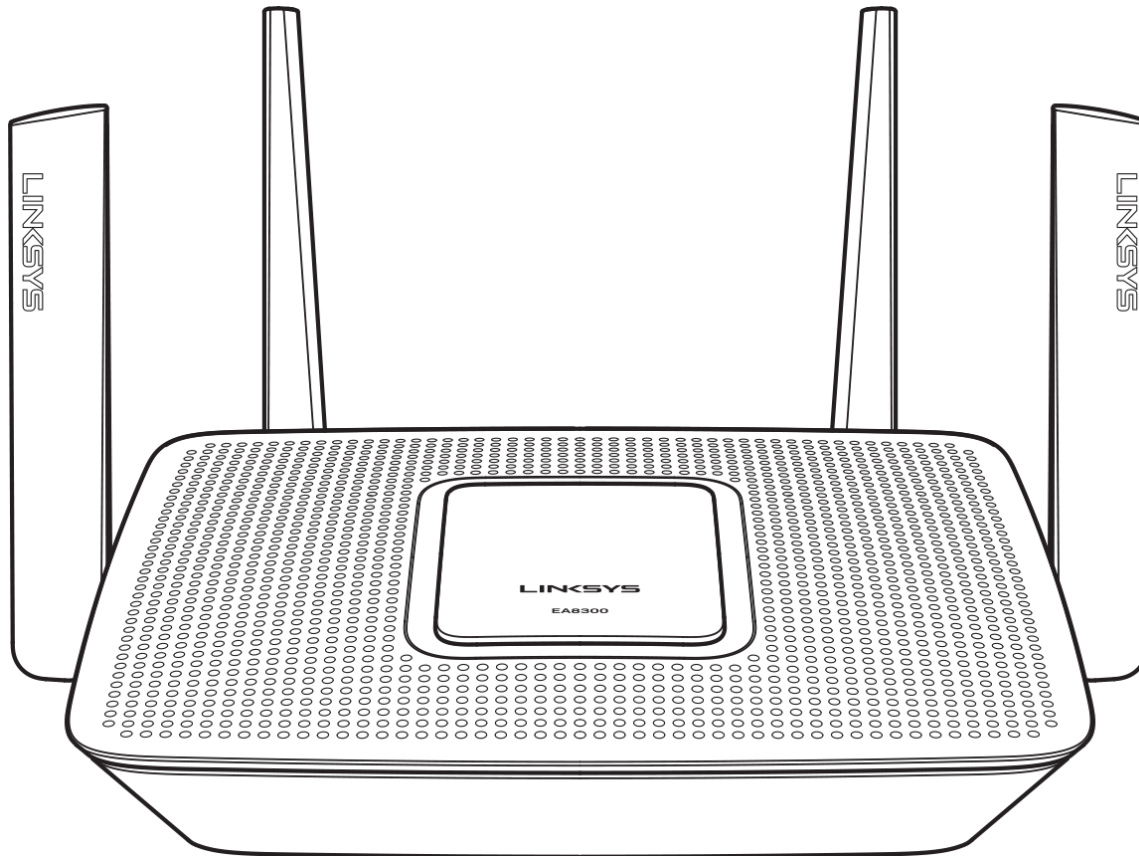

## A rendszer állapotjelzője

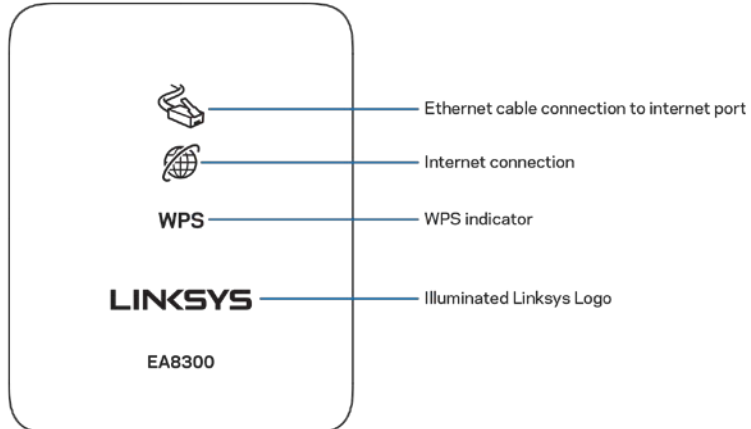

**Ethernet kábelkapcsolat az Internet porthoz** - (narancssárgán) világítva jelzi, ha probléma lépett fel az Internet (WAN) porthoz kapcsolódó hálózati kábellel.

**Internetkapcsolat** - (narancssárgán) világítva jelzi, ha a router nem éri el az internetet.

**WPS (Wi-Fi Protected Setup™ (Wi-Fi védett telepítés)) kijelző** – a WPS kijelzőnek négy állapota van:

<b>Kikapcsolva</b>	Nincs Wi-Fi Protected Setup tevékenység
<b>Fehéren villog</b>	Wi-Fi Protected Setup felépítése folyamatban
<b>Fehéren világít</b>	Wi-Fi Protected Setup felépítése sikerült; öt másodpercig világít
<b>Narancssárgán villog</b>	Wi-Fi Protected Setup hiba; egy percig villog, majd kialszik

**Világító Linksys embléma** - Az embléma a router bekapcsolása alatt villog. Amikor az embléma folyamatosan világít, a router be van kapcsolva és megfelelően működik.

## Hátulnézet

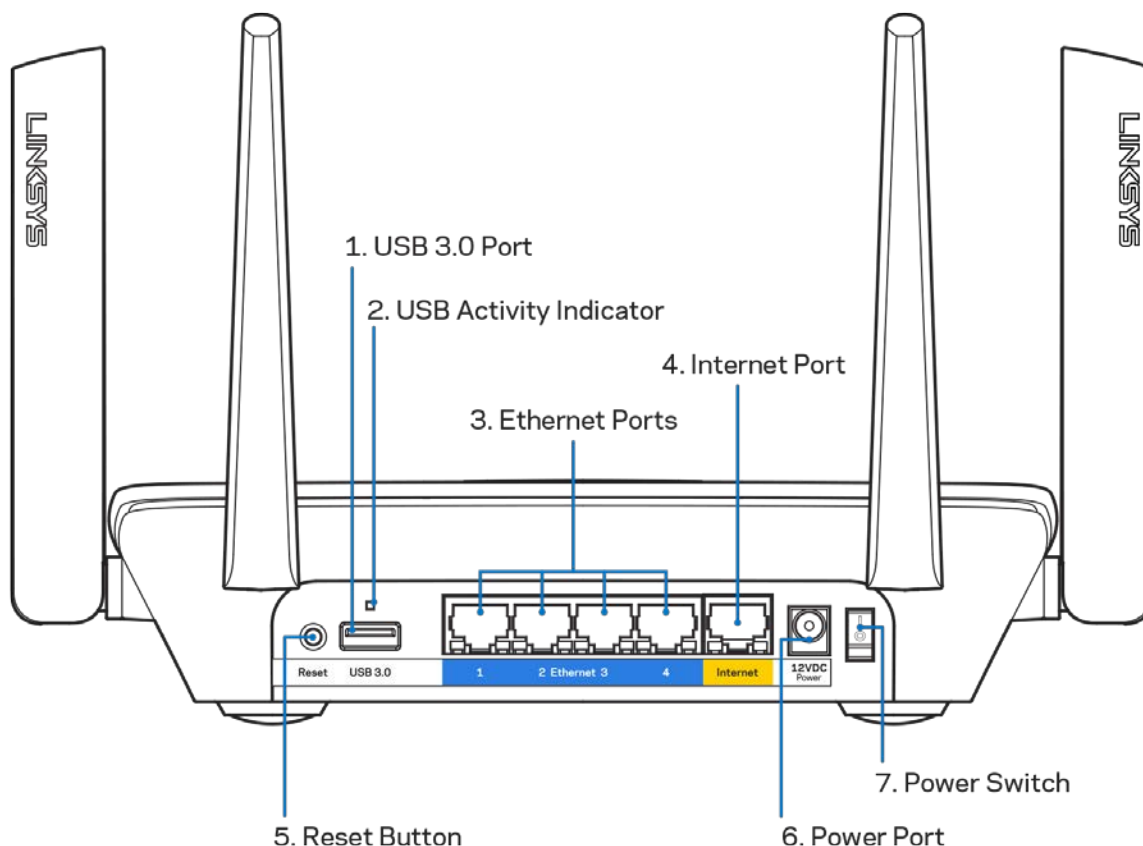

**USB 3.0 port (1)** - Csatlakoztasson USB meghajtókat, és ossza meg azokat a hálózaton vagy az interneten.

**USB-tevékenység kijelző (2)** - A külső eszközök be/kimenő adatátvitelét jelezi.

**Ethernet portok (3)** - Kösse össze ethernet-kábellel ezeket a kék, gigabites (10/100/1000) portokat a hálózat vezetékes eszközeivel.

**Megjegyzés** - A legjobb teljesítmény érdekében használjon CAT5e vagy jobb kábeleket az Ethernet portokhoz.

**Internet port (4)** - Kösse össze ethernet-kábellel ezt a sárga, gigabites (10/100/1000) portot a szélessávú internet kábel/DSL modemmel.

**Megjegyzés** - A legjobb teljesítmény érdekében használjon CAT5e vagy jobb kábelt az Internet porthoz.

**Alaphelyzetbe állító gomb (5)** - Tartsa lenyomva a router gyári beállításainak visszaállításához, amíg ki nem kapcsol a világító Linksys embléma. A gyári beállításokat a Linksys Smart Wi-Fi használatával is visszaállíthatja az interneten keresztül, vagy mobilalkalmazásból.

**Tápfeszültség-csatlakozó (6)** - A mellékelt hálózati adapter csatlakoztatása.

**Főkapcsoló (7)** - A router bekapcsolásához nyomja meg az | (be) gombot.

## Oldalnézet

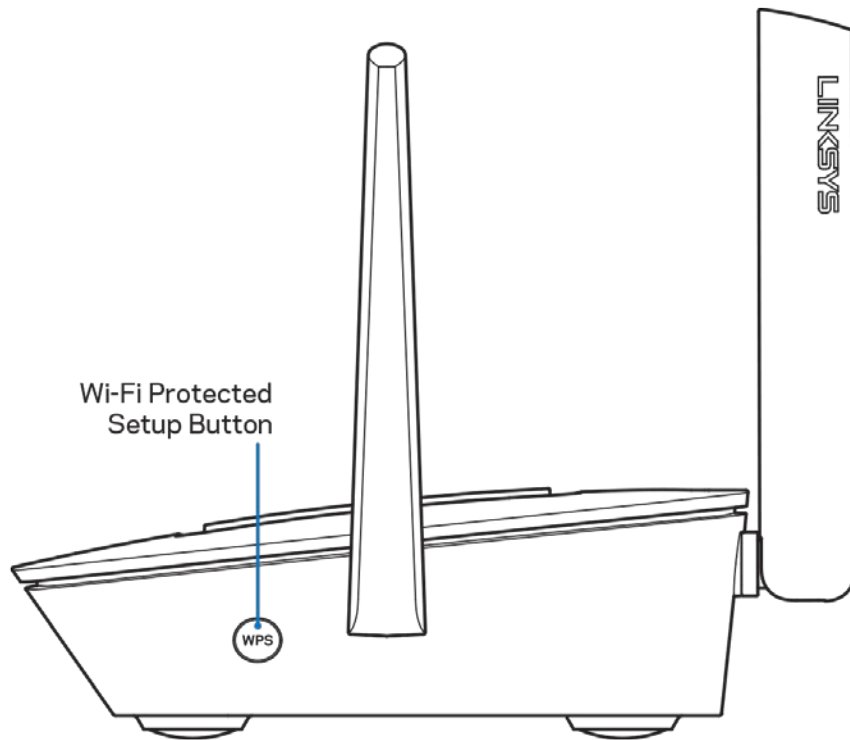

**Wi-Fi Protected Setup™ gomb** - Nyomja meg a WPS-kompatibilis hálózati eszközök csatlakoztatásához.

# Beállítás: Alapok

## Hol találok további segítséget

A felhasználói kézikönyv mellett további segítséget az alábbi helyeken talál:

- [Linksys.com/support/EA8300](http://Linksys.com/support/EA8300) (dokumentáció, letöltések, GYIK, technikai támogatás, élő csevegés, fórumok)
- Linksys Smart Wi-Fi sűgó (csatlakozzon a Linksys Smart Wi-Fi szolgáltatáshoz, majd a képernyő tetején kattintson a Sűgó lehetőségre)

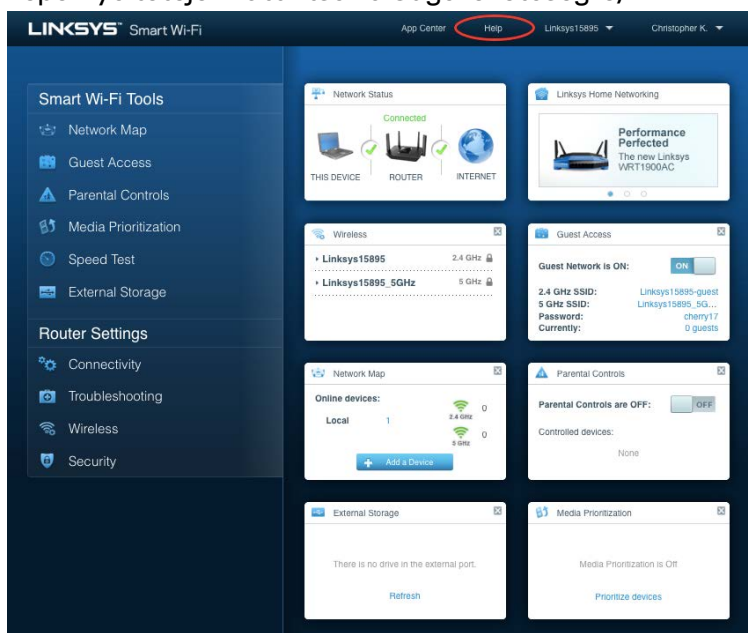

The screenshot shows the Linksys Smart Wi-Fi web interface. The top navigation bar includes 'App Center', 'Help' (highlighted with a red circle), 'Linksys15895', and 'Christopher K.'. The main content area is divided into several sections: 'Smart Wi-Fi Tools' (Network Map, Guest Access, Parental Controls, Media Prioritization, Speed Test, External Storage), 'Router Settings' (Connectivity, Troubleshooting, Wireless, Security), 'Network Status' (Connected), 'Linksys Home Networking' (Performance Perfected), 'Wireless' (2.4 GHz, 5 GHz), 'Guest Access' (ON), 'Network Map' (Online devices), 'Parental Controls' (OFF), 'External Storage' (No drive), and 'Media Prioritization' (OFF).

**Help**

**Using Linksys Smart Wi-Fi**

Linksys Smart Wi-Fi allows you to access all of your router's features and settings. Simply click on a feature or widget you want to open.

You can use Linksys Smart Wi-Fi to:

- See what's currently connected to your network, and connect more computers and devices.
- Create a Linksys Smart Wi-Fi account to access router settings from anywhere using any browser, even when you're away from home. You can personalize your router and change settings for wireless access, Internet, gaming, local network, and more. You can even access router settings for multiple routers, which is helpful if you set up and manage more than one router. (The account is available only on EA-Series routers.)
- Allow guests in your home to use the Internet without giving them access to your network. While on the guest network, users can surf the net, but won't be able to access your printers, other computers, or devices on your network.

**Help Categories**

- Linksys Smart Wi-Fi
- Device List
- Guest Access
- Parental Controls
- Media Prioritization
- Speed Test
- External Storage
- Connectivity

Ok

**Megjegyzés** - A termékben felhasznált külső szoftverek licencei és előírásai a következő címen találhatóak: <http://support.linksys.com/en-us/license>. Ha kérdése van, vagy ha a GPL forráskódra van szüksége, kérjük lépjen velünk kapcsolatba a <http://support.linksys.com/en-us/gplcodecenter> címen.

## A router telepítése

1. A beállítás elvégzéséhez egy számítógép böngészőjében látogasson el a <http://LinksysSmartWiFi.com> címre.
2. Azonosítsa a berendezést.

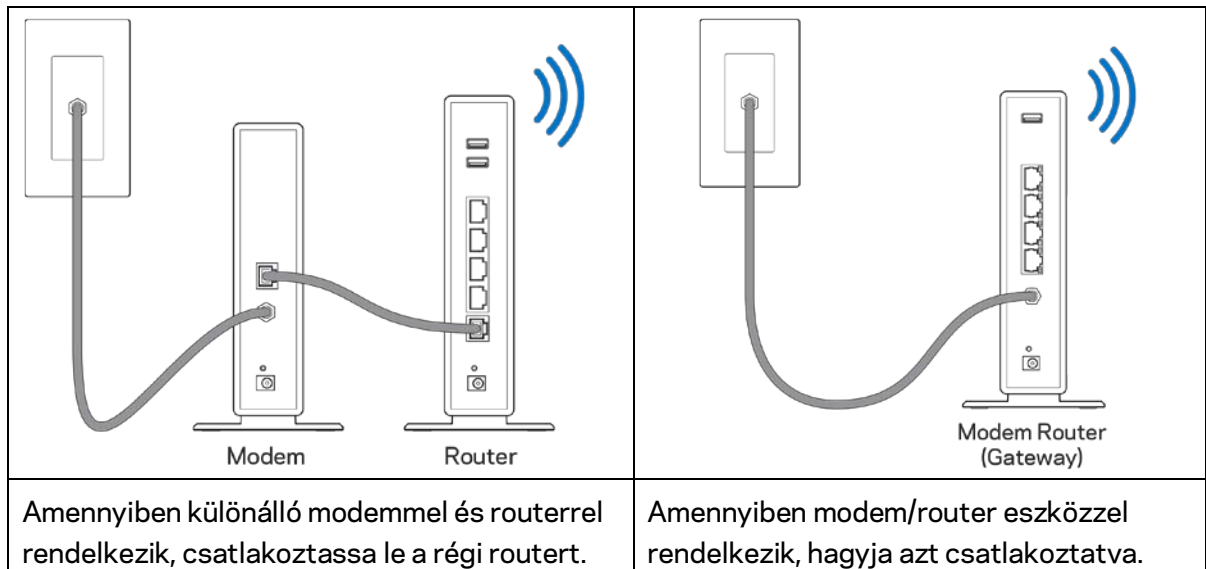

3. Állítsa az antennákat egyenesen felfelé, majd csatlakoztassa a routert az elektromos hálózathoz. Ellenőrizze, hogy a főkapcsoló a | (be) állásba van-e kapcsolva.
4. Csatlakoztassa a routert a modemhez vagy a modem/routerhez. Csatlakoztassa a mellékelt internetkábel egyik végét az új router sárga internetportjához. Amennyiben modeme van, csatlakoztassa a kábel másik végét a modem Ethernet (LAN) portjához. Amennyiben modem/routerre van, csatlakoztassa azt bármelyik szabad porthoz.
5. Várjon amíg a router tetején a világító Linksys embléma abbahagyja a villogást és folyamatosan fehérén nem kezd világítani.
6. Csatlakozzon a routerhez mellékelt Gyors kezdő útmutatóban feltüntetett Wi-Fi-hálózatnévhez. (Ezeket a beállításokat később módosíthatja.) Ha segítségre van szüksége a hálózati csatlakozásnál, olvassa el a dokumentációt a [linksys.com/support/EA8300](http://linksys.com/support/EA8300) címen.

**Megjegyzés** - Az útválasztó beállításának befejezéséig nem lesz internet-hozzáférése.

7. Írja be a böngészőbe a <http://LinksysSmartWiFi.com> címet. A router konfigurálásának befejezéséhez kövesse a képernyőn megjelenő utasításokat. A beállítás megkezdéséhez a 192.168.1.1 címet is beírhatja a böngészőbe.

A Linksys Smart Wi-Fi-fiók beállításához a telepítés végén kövesse a képernyőn megjelenő utasításokat. A Linksys Smart Wi-Fi használatával bármilyen internetkapcsolattal rendelkező számítógépről beállíthatja a routert.

A router beállításainak kezelése:

- A router nevének és jelszavának módosítása
- Vendég hozzáféréseinek beállítása
- Szülői felügyelet beállítása
- Eszközök csatlakoztatása a Wi-Fi-hálózathoz
- Internetkapcsolat sebességének tesztelése

**Megjegyzés** - *A Linksys Smart Wi-Fi-fiók beállítása során kapni fog egy ellenőrző e-mailt. Otthoni hálózatáról kattintson az e-mailben kapott linkre, hogy összekapcsolja routerét a Linksys Smart Wi-Fi-fiókkal.*

**Tipp** - *Nyomtassa ki a következő oldalt, majd jegyezze fel router- és fiókadatát a táblázatban, hogy később is hozzáférhessen azokhoz. Jegyzeteit biztonságos helyen tárolja.*

2,4 GHz-es Wi-Fi-hálózat neve	
Wi-Fi-hálózat jelszava	
5 GHz-es <sub>1</sub> Wi-Fi-hálózat neve	
Wi-Fi-hálózat jelszava	
5 GHz-es <sub>2</sub> Wi-Fi-hálózat neve	
Wi-Fi-hálózat jelszava	
Jelszó a routerhez	
2,4 GHz-es vendég Wi-Fi-hálózat neve	
5 GHz-es vendég Wi-Fi-hálózat neve	
Vendég Wi-Fi-hálózat jelszava (Mindkettőnek ugyanaz a jelszava.)	
Linksys Smart Wi-Fi felhasználónév	
Linksys Smart Wi-Fi jelszó	



# A Linksys Smart Wi-Fi használata

A világ bármely pontjáról beállíthatja a routerét a Linksys Smart Wi-Fi segítségével, de ezt közvetlenül az otthoni hálózatról is elvégezheti. Lehet, hogy a Linksys Smart Wi-Fi mobilkészülékről is elérhető. További információért látogasson el eszköze alkalmazásboltjába.

## Csatlakozás a Linksys Smart Wi-Fi szolgáltatáshoz

Ahhoz, hogy csatlakozzon a Linksys Smart Wi-Fi szolgáltatáshoz:

1. Nyissa meg a webböngészőt számítógépén.
2. Látogasson el a <http://LinksysSmartWiFi.com> oldalra, és jelentkezzen be fiókjába.

Linksys Smart Wi-Fi Sign In

If you have not yet created a Linksys Smart Wi-Fi account, click the "Create Account" button in the upper right corner of the page.

Give guests Internet access

Use your Linksys Smart Wi-Fi account to access your home network from anywhere, at any time, even from your mobile device. Easily connect new devices, set parental controls, get access to Smart Wi-Fi mobile Apps, and more.

For more information [click here](#)

English (United States)

For local access, [click here](#).

Ha nem emlékszik a jelszavára, kattintson a *Forgot your password?* (Elfelejtette a jelszavát?) lehetőségre, és kövesse a képernyőn megjelenő utasításokat annak visszaállításához.

## Hálózati térkép

Segítségével megjelenítheti és kezelheti a routerhez csatlakoztatott összes hálózati eszközt. Megtekintheti a fő hálózathoz és a vendég hálózathoz csatlakozó eszközöket és információkat jeleníthet meg az egyes eszközökkel kapcsolatban.



## Vendég hozzáférés

Wi-Fi-hozzáférés beállítása és felügyelete a vendégek számára a személyes adatok elérhetővé tétele nélkül.

The screenshot shows the 'Guest Access' configuration page. At the top, there is a title 'Guest Access' and a checkbox 'Show widget on the homepage' which is checked. Below the title, there is a subtitle 'Guest access allows visitors to connect to your wireless guest network and access the Internet, without giving access to your other computers or personal data.' The main area is divided into three sections: 'Allow guest access' with a toggle switch set to 'ON'; 'Guest network names and password' with fields for 2.4 GHz SSID (parlor2.4), Network (Enabled), 5 GHz SSID (parlor5), Network (Enabled), and Guest network password (they); and 'Total guests allowed' with a dropdown menu set to '5 guests'. A warning box with an exclamation mark icon contains the text: 'Your guest should first connect to your guest network, open a web browser, and then enter the guest password.' At the bottom, there are 'OK' and 'Cancel' buttons.

## Szülői felügyelet

Blokkolhat vele weboldalakat, és beállíthatja, hogy mikor lehessen hozzáférni az internethez.

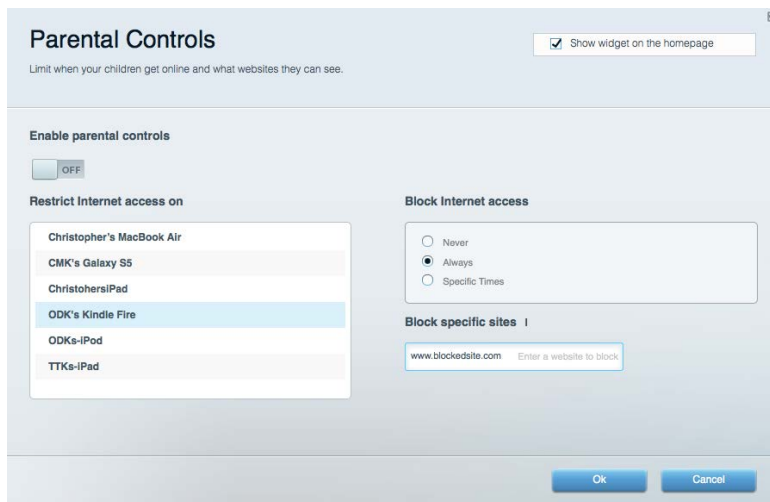

## Média rangsorolás

A segítségével beállítható, mely eszközök és alkalmazások élvezzenek prioritást a hálózati forgalomban.

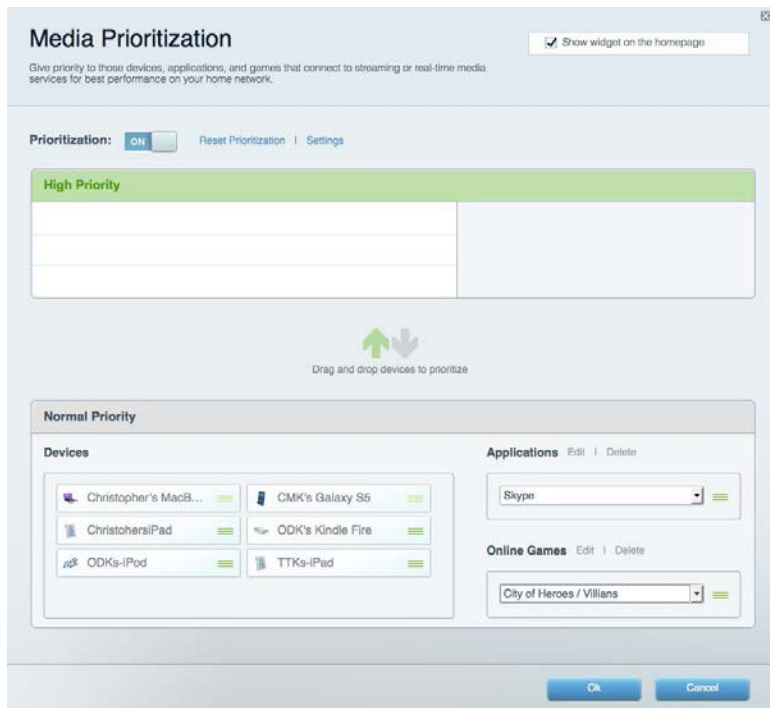

## Sebességteszt

Lehetővé teszi a hálózat internetkapcsolatának sebességének tesztelését.



## Külső tárhely

A funkción keresztül érhető el a csatlakoztatott USB meghajtó (nem tartozék) és állítható be a fájlok megosztása, a médiakiszolgáló és az FTP hozzáférés.



## Csatlakoztathóság

Az alapvető és haladó hálózati beállítások megtekintése és módosítása.

The screenshot shows the 'Connectivity' settings page of a router. It features a navigation bar with tabs for 'Basic', 'Internet Settings', 'Local Network', 'Advanced Routing', 'VLAN', and 'Administration'. The 'Basic' tab is active. The page is divided into several sections: 'Network Name and Password' with fields for 2.4 GHz and 5 GHz network names and passwords; 'Router Password' with a masked password field; 'Router Firmware Update' with a checked 'Automatic' option and a 'Check for Updates' button; 'Time Zone' with a dropdown menu set to '(GMT-05:00) Eastern Time (USA & Canada)' and a checked 'Automatically adjust for Daylight Savings Time' option; and 'Activity Lights' with an 'ON' toggle and a descriptive text box. At the bottom, there are 'Ok', 'Cancel', and 'Apply' buttons.

## Hibaelhárítás

Segít feltárni a routerrel kapcsolatos problémák okát és ellenőrizni a hálózat állapotát.

The screenshot shows the 'Troubleshooting' settings page of a router. It features a navigation bar with tabs for 'Status', 'Diagnostics', and 'Logs'. The 'Diagnostics' tab is active. The page is divided into several sections: 'Ping IPv4' with input fields for IP or host name and number of pings, and a 'Start to Ping' button; 'Trace route' with an input field for IP or host name and a 'Start to Traceroute' button; 'Reboot' with a 'Reboot the router' link; 'Router configuration' with 'Backup' and 'Restore' buttons; 'Router Firmware' with a 'Restore previous firmware' button; 'Internet Address' showing IPv4 (10.0.0.253) and IPv6 (2601:0540::000:0019:0000:0000:0000:314e) addresses with 'Release and Renew' links; and 'Factory reset' with a 'Reset to factory default settings' link. At the bottom, there is an 'Ok' button.

## Vezeték nélküli kapcsolat

A funkció használatával megtekintheti és módosíthatja a router vezeték nélküli hálózatát. Megváltoztathatja a hálózatnevet, a biztonsági üzemmódot, a jelszót, a MAC-szűrést, és a Wi-Fi Protected Setup használatával eszközöket csatlakoztathat.

Wireless

View and change router settings

Wireless MAC Filtering Wi-Fi Protected Setup

Smart Connect:  5 GHz band steering  Off  
5 GHz<sub>1</sub> + 5 GHz<sub>2</sub> Individual networks What is Smart Connect band steering?

Network name: arachnid 2.4 GHz Network:  ON

Password: peterparker Broadcast SSID: Yes Channel: Auto

Security mode: WPA2/WPA Mixed Pa Network mode: Mixed Channel width: Auto

Network name: arachnid\_5GHz 5 GHz<sub>1</sub> + 5 GHz<sub>2</sub> Network:  ON

Password: peterparker Broadcast SSID: Yes Channel: Auto

Security mode: WPA2/WPA Mixed Pa Network mode: Auto Channel width: Auto

Ok Cancel Apply

## Biztonság

A funkció használatával megtekintheti és módosíthatja a router vezeték nélküli biztonsági beállításait. Megadhatja a tűzfal és a VPN beállításait, és egyéni beállításokat adhat meg egyes alkalmazásokra és játékokra vonatkozóan.

Security

View and change router settings

Firewall DMZ Apps and Gaming

**Firewall**

IPv4 SPI firewall protection  Enabled

IPv6 SPI firewall protection  Enabled

**VPN Passthrough**

IPSec Passthrough  Enabled

PPTP Passthrough  Enabled

L2TP Passthrough  Enabled

**IPv6 Port Services**

Description	Protocol	IPv6 Address	Allow	Enabled
-------------	----------	--------------	-------	---------

Add IPv6 Firewall Setting

**Internet filters**

Filter anonymous Internet requests

Filter multicast

Filter Internet NAT redirection

Filter ident (Port 113)

Ok Cancel Apply

# Hibaelhárítás

További segítséget díjnyertes technikai támogatásunktól a [linksys.com/support/EA8300](http://linksys.com/support/EA8300) címen kaphat.

## A router telepítése nem sikerült

Ha a Linksys Smart Wi-Fi nem fejezi be a beállítást, megpróbálhatja a következő lépéseket:

- Egy iratkapocs vagy egy tű segítségével tartsa lenyomva a routeren az Alaphelyzetbe állító gombot amíg ki nem kapcsol a világító Linksys embléma és a kék MU-MIMO kijelzők el nem kezdenek villogni (körülbelül 10 másodpercig). Telepítse újra az útválasztót.

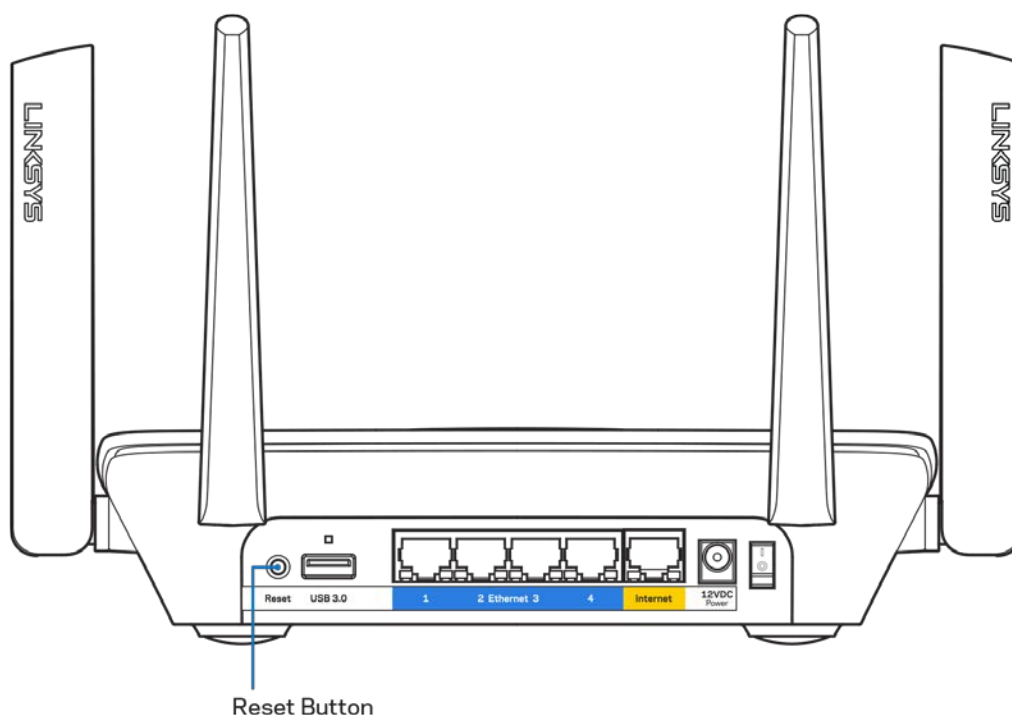

- Ideiglenesen kapcsolja ki a számítógép tűzfalát (lásd a biztonsági szoftver használati utasítását). Telepítse újra az útválasztót.
- Ha rendelkezik másik számítógéppel, használja azt az útválasztó ismételt telepítésére.

## ***Your Internet cable is not plugged in* (Az internetkábel nincs csatlakoztatva) üzenet**

Ha megjelenik „Az internetkábel nincs csatlakoztatva” üzenet az útválasztó telepítése közben, akkor kövesse ezeket a hibaelhárítási lépéseket.

- Győződjön meg róla, hogy az ethernet- vagy internet-kábel (vagy egy olyan kábel, mint a routerhez mellékelt) stabilan csatlakozik a sárga internet porthoz a router hátulján, illetve a modem megfelelő portjához. Ezt a portot a modemen általában Ethernet jelzéssel látják el.

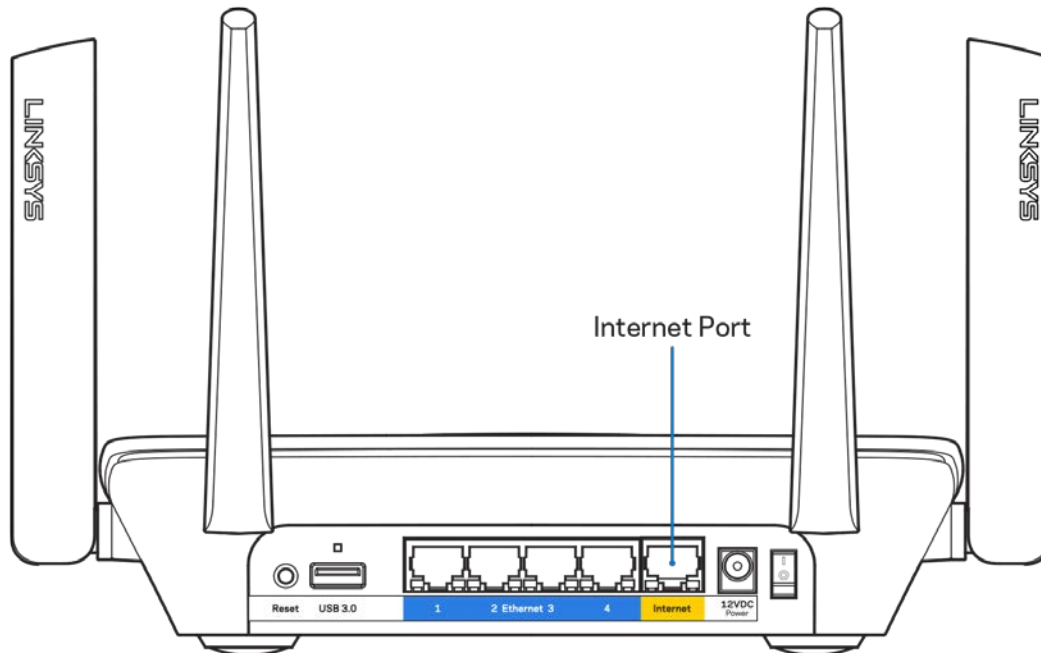

- Győződjön meg róla, hogy a modem csatlakoztatva van az elektromos hálózathoz, és be van kapcsolva. Ha van főkapcsolója, győződjön meg róla, hogy az ON (Be) vagy I (nem 0) állásban van.

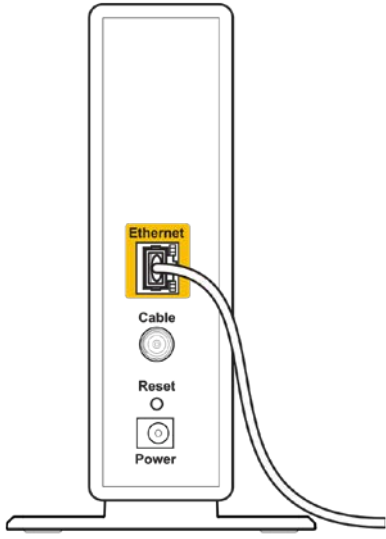
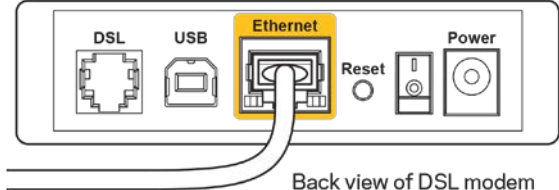

 <p>Back view of cable modem</p>	 <p>Back view of DSL modem</p>
<p>Ha az internetes szolgáltatás kábeles, akkor ellenőrizze, hogy a kábelmodem CABLE portja csatlakozik-e az internetszolgáltató által biztosított koaxiális kábelhez.</p>	<p>Ha az internetes szolgáltatás DSL, győződjön meg róla, hogy a DSL telefonvonal csatlakozik a modem DSL portjához.</p>

- Ha a számítógép korábban USB-kábelen kapcsolódott a modemhez, akkor húzza ki az USB-kábelt.
- Telepítse újra a routert.

## **Cannot access your router (Az útválasztó nem érhető el) üzenet**

A router eléréséhez csatlakoznia kell a saját hálózatához. Ha rendelkezik vezeték nélküli internet-hozzáféréssel, a probléma oka lehet az is, hogy véletlenül egy másik vezeték nélküli hálózathoz csatlakozott.

A probléma megoldásához Windows rendszerű számítógépeken tegye a következőt\*:

1. A tálcán kattintson a vezeték nélküli ikonra. Meg fog jelenni az elérhető hálózatokat tartalmazó lista.

2. Kattintson a saját hálózata nevére. Kattintson a Connect (Csatlakozás) lehetőségre. Az alábbi példában a számítógép egy másik vezeték nélküli hálózathoz csatlakozott, melynek neve: wraith\_5GHz. A példában kiválasztottként a Linksys EA8300 router vezeték nélküli hálózati neve, a Damaged\_Beez2.4 látható.



3. Amikor a rendszer kéri a hálózati biztonsági kulcsot, írja be a jelszót (hálózati kulcsot) a Network security key (Hálózati kulcs) mezőbe. Kattintson az OK gombra.
4. A számítógép csatlakozik a hálózathoz, és ettől fogva elérhető az útválasztó.

*\*A Windows verziójától függően eltérések lehetnek a lépésekben említett kifejezésekben vagy ikonokban.*

A probléma megoldásához Macintosh rendszerű számítógépeken tegye a következőt:

1. A képernyő felső részén található menüsoron kattintson a Wi-Fi ikonra. Meg fog jelenni a vezeték nélküli hálózatokat tartalmazó lista.
2. Az alábbi példában a számítógép egy másik vezeték nélküli hálózathoz csatlakozott, melynek neve: wraith\_5GHz. A példában kiválasztottként a Linksys EA8300 router vezeték nélküli hálózati neve, a Damaged\_Beez2.4 látható.



3. Kattintson a Linksys EA8300 router vezeték nélküli hálózatának nevére (a példában Damaged\_Beez2.4).
4. Írja be a vezeték nélküli hálózat jelszavát (Biztonsági kulcs) a *Password* (Jelszó) mezőbe. Kattintson az **OK** gombra.

## A telepítés után

### Úgy tűnik nem érhető el az internet

Amennyiben az internet nehezen tud kommunikálni a routerrel, előfordulhat, hogy a probléma a „Cannot find [Internet address]” (Az internetcím nem található) üzenetként jelenik meg a webböngészőben. Amennyiben tudja, hogy az internetcím helyes, és több érvényes internetcímet is kipróbált ugyanezt az eredményt kapva, az üzenet azt jelenti, hogy a probléma lépett fel az internetszolgáltató vagy a modem és a router közötti kommunikációban. Próbálja meg a következőket:

- Ellenőrizze, hogy a hálózati és a tápkábelek stabilan csatlakoznak-e.
- Ellenőrizze, hogy a konnektorban, amihez a router csatlakozik van-e áram.
- Indítsa újra a routert.
- Lépjen kapcsolatba az internetszolgáltatóval és érdeklődjön, nincs-e leállítás az Ön körzetében.

A router leggyakrabban használt hibaelhárítási módja annak kikapcsolása, majd visszakapcsolása. Ezután a router képes újra betölteni egyéni beállításait, és más eszközök (például a modem) újra megtalálhatják a routert, és ismét képesek kommunikálni vele. Ezt a folyamatot újraindításnak nevezik.

A router újraindításához a tápkábellel tegye a következőket:

1. Húzza ki a tápkábelt a routerből és a modemből.
2. Várjon 10 másodpercet, majd csatlakoztassa újra a modem tápkábelét. Ellenőrizze, hogy bekapcsol-e.
3. Várjon amíg a modem online kijelzői abbahagyják a villogást (legalább egy-két perc). Csatlakoztassa a tápkábelt a routerhez.

4. Várjon, amíg a Linksys embléma elkezd világítani. Várjon két percig, mielőtt megpróbálna kapcsolódni az internethez egy számítógépről.

A router újraindításához a Linksys Smart Wi-Fi segítségével tegye a következőket:

1. Jelentkezzen be a Linksys Smart Wi-Fi szolgáltatásba. (Lásd a „Csatlakozás a Linksys Smart Wi-Fi szolgáltatáshoz” szakaszt a [11.](#) oldalon.)
2. A *Router Settings* (Router beállításai) alatt kattintson a *Troubleshooting* (Hibaelhárítás) lehetőségre.
3. Kattintson a *Diagnostics* (Diagnosztika) fülre.
4. A *Reboot* (Újraindítás) alatt kattintson a Reboot lehetőségre.



5. Kattintson a **Yes** (Igen) lehetőségre. A router újraindul. A router újraindítása alatt az összes csatlakoztatott eszköz elveszti az internetkapcsolatot, és automatikusan újra csatlakozik, ha a router ismét készen áll.

## A Linksys Smart Wi-Fi nem nyílik meg a webböngészőben

A Linksys Smart Wi-Fi a Google Chrome™, a Firefox®, a Safari® (Mac® és iPad® eszközökhöz), a Microsoft Edge legújabb verzióival, és az Internet Explorer® 8-as vagy újabb verziójával működik.

# Műszaki adatok

## Linksys EA8300

Típusnév	Max-Stream AC2200 MU-MIMO háromsávós router
Típuszám	EA8300
Sebesség	10/100/1000 Mb/s (Gigabit Ethernet)
Rádiófrekvencia	2,4 GHz és 5 GHz (x2)
Antennák száma	4 külső beállítható antenna (nem leszerelhető)
Portok	USB 3.0, Ethernet (1-4), Internet, Tápfeszültség
Gombok	Wi-Fi védett telepítés, Főkapcsoló, Reset (alaphelyzet)
Lámpák	<b>Felső panel:</b> Világító Linksys embléma, Wi-Fi Protected Setup, Internetkapcsolat, Hálózati kábelkapcsolat az internet porthoz <b>Hátsó panel:</b> USB, Ethernet (1-4), Internet
UPnP	Támogatott
Biztonsági funkciók	WEP, WPA2, RADIUS
Biztonsági kulcs bitekben	Akár 128 bites titkosítás
Fájlrendszer támogatás	FAT, NTFS és HFS+
Webböngészőtámogatás	A Google Chrome™, a Firefox®, a Safari® (Mac® és iPad® eszközökhöz), a Microsoft Edge legújabb verzióival és az Internet Explorer® 8-as vagy újabb verziójával működik.

## Beépítési adatok

Méretek	213,7mm x 161,8mm x 54,8mm (antennák nélkül)
Készülék tömege	608 g
Tápellátás	12 V; 2A
Tanúsítványok	FCC, IC, CE, Wi-Fi (a/b/g/n/ac)
Üzemi hőmérséklet	0 és 40 °C között
Tárolási hőmérséklet	-20 és 60 °C között
Üzemi páratartalom	10-80% közötti relatív páratartalom, lecsapódás nélkül
Tárolási páratartalom	5% - 90%, lecsapódás nélkül

A specifikációk előzetes értesítés nélkül változhatnak.

#### Megjegyzések:

A szabályozásokkal, a jótállással és a biztonsággal kapcsolatos információkért tekintse meg a routerhez mellékelt CD-t vagy látogasson el az [Linksys.com/support/EA8300](http://Linksys.com/support/EA8300) címre.

A maximális teljesítmény meghatározása az IEEE 802.11 szabvány specifikációi alapján történt. A tényleges teljesítmény változhat, beleértve a kisebb vezeték nélküli hálózati teljesítményt, adatátviteli arányt, hatósugarat és lefedettséget. A teljesítményt számos állandó és ideiglenes tényező, illetve környezeti feltétel befolyásolhatja. Ilyen például a hozzáférési ponttól való távolság, a hálózati forgalom nagysága, az épület építőanyagai és szerkezete, az operációs rendszer, a használt vezeték nélküli eszközök, az interferencia és egyéb zavaró környezeti hatások.

A BELKIN, LINKSYS és más terméknevek és emblémák a Belkin vállalatcsoport védjegyei. Az egyéb védjegyek az adott harmadik fél tulajdonában állnak. A termékben felhasznált külső szoftverek licencei és előírásai itt találhatóak: <http://support.linksys.com/en-us/license>. Ha kérdése van, vagy ha a GPL forráskódra van szüksége, kérjük, lépjen velünk kapcsolatba a <http://support.linksys.com/en-us/gplcodecenter> címen.

© 2017 Belkin International, Inc. és/vagy annak leányvállalatai. Minden jog fenntartva.

**LINKSYS®**

Panduan Pengguna

**MAX-STREAM™  
AC2200 MU-MIMO  
TRI-BAND ROUTER**

Model EA8300

# Daftar Isi

Ringkasan Produk .....	3
Tampak atas .....	3
Indikator status sistem .....	4
Tampak belakang .....	5
Tampak samping .....	6
Pengaturan: Dasar .....	7
Bantuan lebih lanjut .....	7
Cara memasang router Anda .....	8
Cara Menggunakan Wi-Fi Pintar Linksys .....	11
Cara menyambungkan ke Wi-Fi Pintar Linksys .....	11
Peta Jaringan .....	12
Akses Tamu .....	12
Kendali Orang Tua .....	13
Prioritas Media .....	13
Uji Kecepatan .....	14
Penyimpanan Eksternal .....	14
Konektivitas .....	15
Pemecahan Masalah .....	15
Nirkabel .....	16
Keamanan .....	16
Pemecahan Masalah .....	17
Pengaturan router Anda tidak berhasil .....	17
Pesan <i>kabel Internet Anda tidak tersambung</i> .....	18
Pesan <i>Tidak dapat mengakses router Anda</i> .....	19
Setelah pengaturan .....	21
Internet sepertinya tak tersedia .....	21
Wi-Fi Pintar Linksys tidak terbuka pada browser web Anda .....	22
Spesifikasi .....	23
Linksys EA8300 .....	23
Lingkungan .....	23



# Ringkasan Produk

## Tampak atas

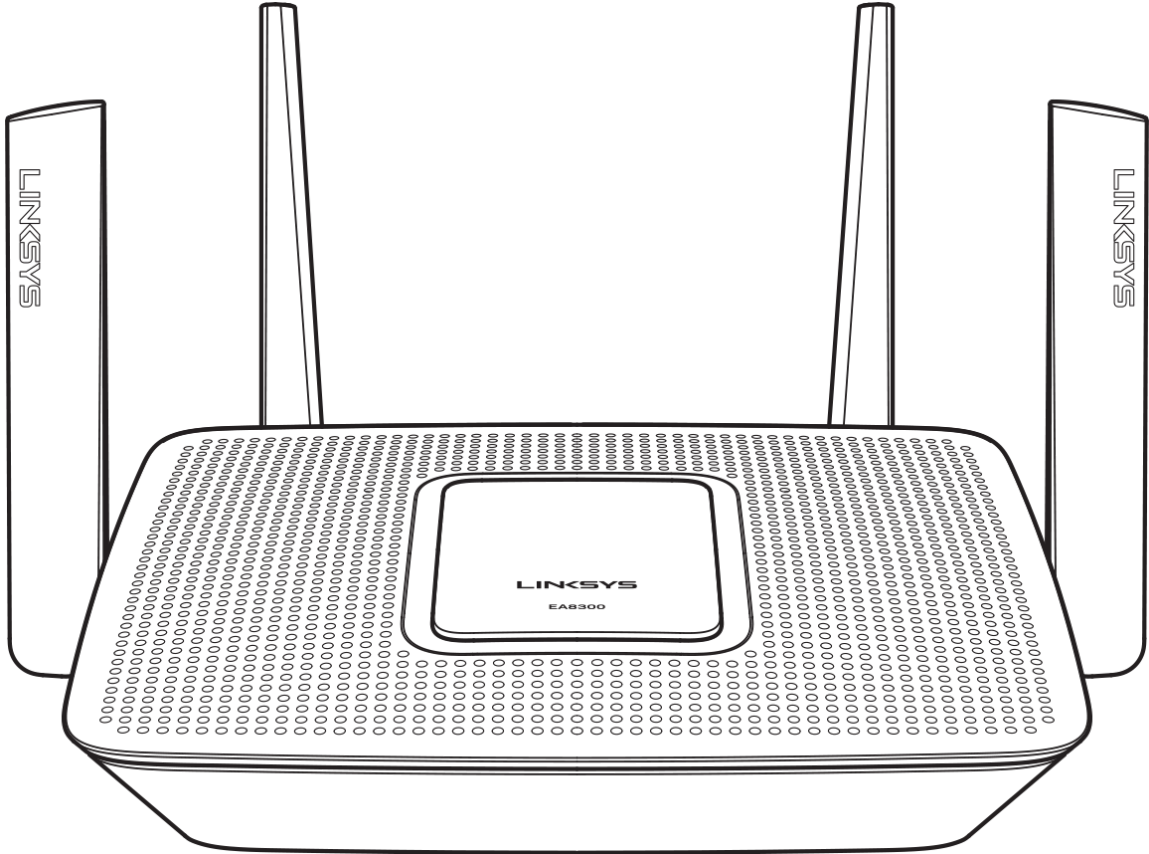

## Indikator status sistem

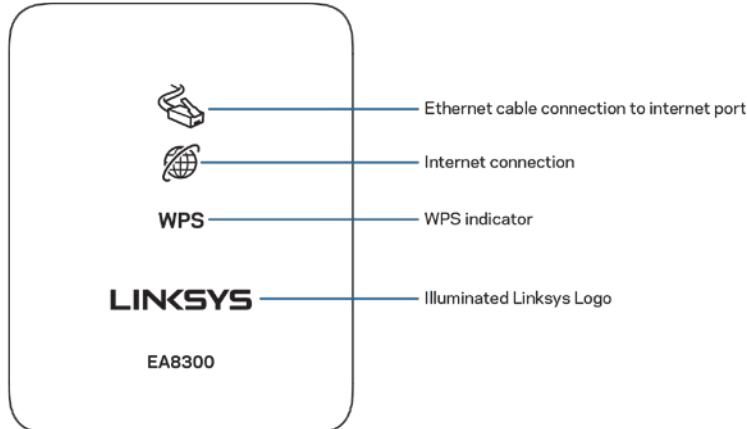

**Sambungan kabel Ethernet ke port Internet**—Ketika menyala (oranye), menunjukkan adanya masalah pada kabel jaringan yang tersambung ke port Internet (WAN).

**Sambungan Internet**—Ketika menyala (oranye), menunjukkan router tidak dapat mengakses internet.

**Indikator WPS (Wi-Fi Protected Setup™)**—Lampu WPS memiliki 4 status:

<b>Mati</b>	Wi-Fi Protected Setup tidak ada aktivitas
<b>Berkedip Putih</b>	Wi-Fi Protected Setup sedang berlangsung
<b>Putih Terang</b>	Wi-Fi Protected Setup berhasil; tetap menyala selama 5 detik
<b>Berkedip oranye</b>	Wi-Fi Protected Setup ada kesalahan; berkedip selama 1 menit, lalu mati

**Lampu Logo Linksys**—Logo berkedip saat router mulai. Saat logo menyala putih terang, router hidup dan beroperasi dengan benar.

## Tampak belakang

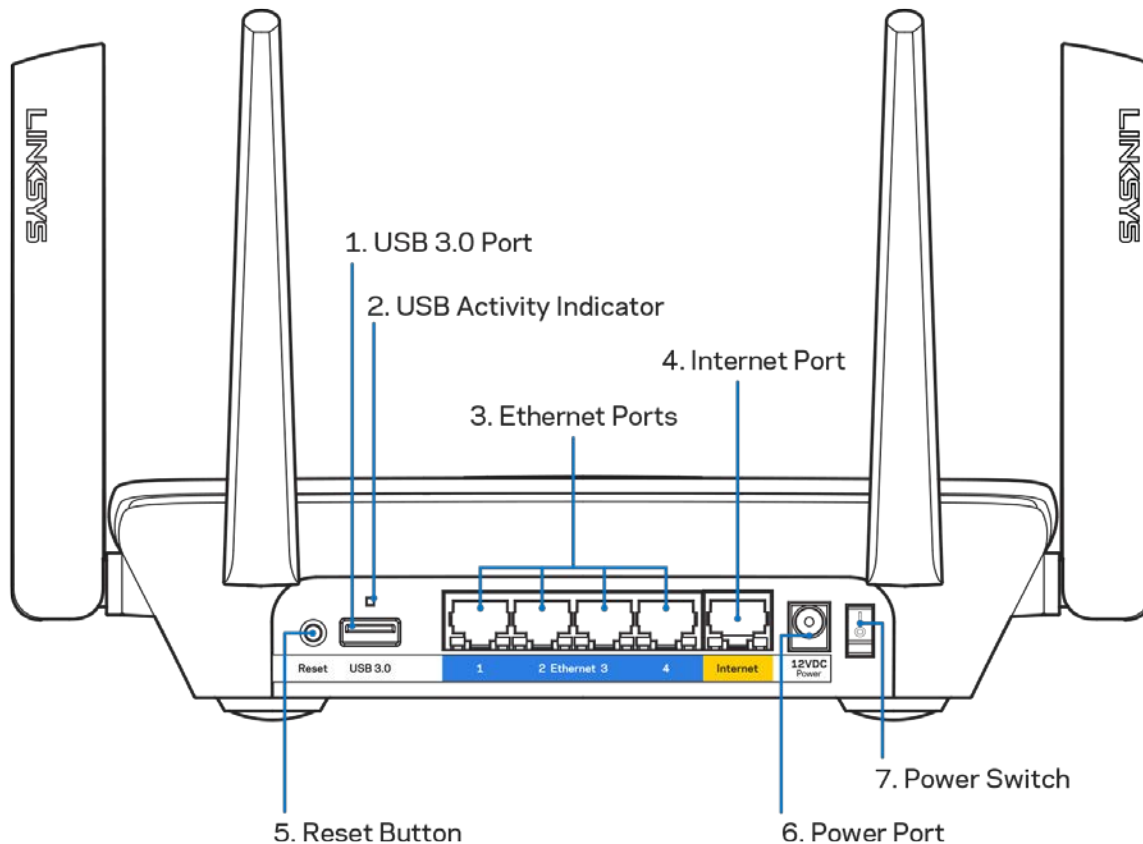

**Port USB 3.0 (1)**—Menyambungkan dan berbagi drive USB pada jaringan Anda atau internet.

**Indikator aktivitas USB (2)**—Lampu menunjukkan transfer data ke/dari perangkat eksternal.

**Port ethernet (3)**—Sambungkan kabel ethernet ke port gigabit (10/100/1000) berwarna biru ini, lalu ke perangkat berkabel pada jaringan Anda.

*Catatan—Untuk performa terbaik, gunakan kabel CAT5e atau kabel dengan kelas lebih tinggi pada port Ethernet.*

**Port internet (4)**—Sambungkan kabel ethernet ke port gigabit (10/100/1000) berwarna kuning ini, dan ke modem internet broadband kabel/DSL atau fiber.

*Catatan—Untuk performa terbaik, gunakan kabel CAT5e atau kabel dengan kelas lebih tinggi pada port Internet.*

**Tombol Atur Ulang (5)**—Tekan terus hingga lampu logo Linksys mati untuk mengatur ulang router ke pengaturan pabrik. Anda juga dapat memulihkan pengaturan pabrik menggunakan Wi-Fi Pintar Linksys melalui internet atau aplikasi seluler.

**Port daya (6)**—Menyambungkan adapter daya AC yang disertakan.

**Sakelar daya (7)**—Tekan | (hidup) untuk menghidupkan router.

## Tampak samping

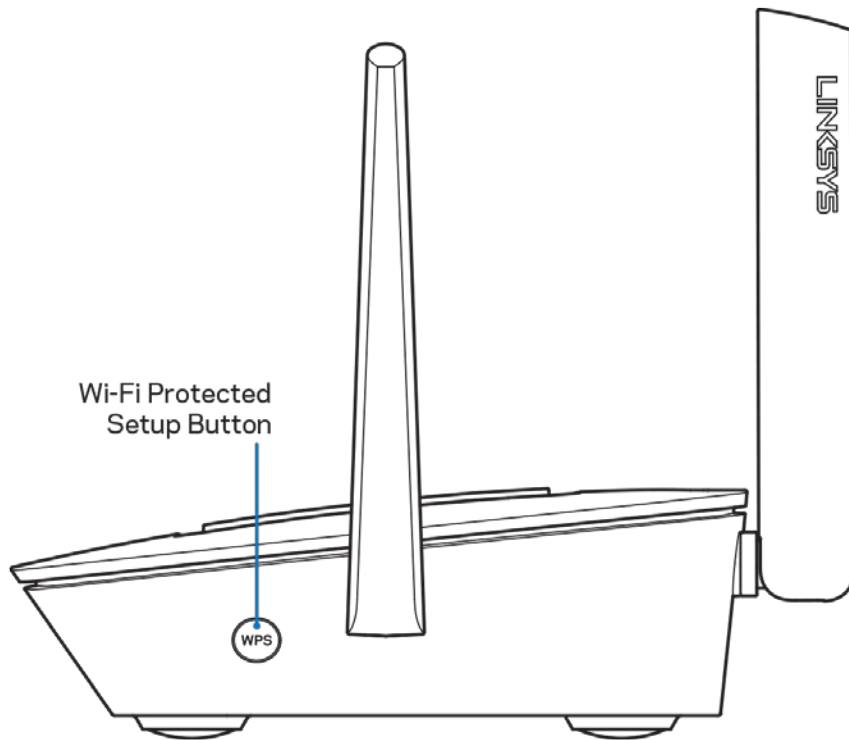

**Tombol Wi-Fi Protected Setup™**—Tekan untuk menyambungkan ke perangkat jaringan berkemampuan WPS.

# Pengaturan: Dasar

## Bantuan lebih lanjut

Selain panduan pengguna ini Anda juga dapat menemukan bantuan di lokasi berikut:

- [Linksys.com/support/EA8300](http://Linksys.com/support/EA8300) (dokumentasi, unduhan, FAQ, dukungan teknis, obrolan langsung, forum)
- Bantuan Wi-Fi Pintar Linksys (sambungkan ke Wi-Fi Pintar Linksys, klik Bantuan pada bagian atas layar)

The screenshot shows the Linksys Smart Wi-Fi web interface. The top navigation bar includes 'App Center', 'Help' (highlighted with a red circle), 'Linksys15895', and 'Christopher K.'. The main interface is divided into 'Smart Wi-Fi Tools' and 'Router Settings'. The 'Help' dialog box is open, showing the following content:

**Help**

**Using Linksys Smart Wi-Fi**

Linksys Smart Wi-Fi allows you to access all of your router's features and settings. Simply click on a feature or widget you want to open.

You can use Linksys Smart Wi-Fi to:

- See what's currently connected to your network, and connect more computers and devices.
- Create a Linksys Smart Wi-Fi account to access router settings from anywhere using any browser, even when you're away from home. You can personalize your router and change settings for wireless access, Internet, gaming, local network, and more. You can even access router settings for multiple routers, which is helpful if you set up and manage more than one router. (The account is available only on EA-Series routers.)
- Allow guests in your home to use the Internet without giving them access to your network. While on the guest network, users can surf the net, but won't be able to access your printers, other computers, or devices on your network.

**Help Categories**

- Linksys Smart Wi-Fi
- Device List
- Guest Access
- Parental Controls
- Media Prioritization
- Speed Test
- External Storage
- Connectivity

Ok

**Catatan**—*Lisensi dan pemberitahuan untuk perangkat lunak pihak ketiga dalam produk ini dapat dilihat di <http://support.linksys.com/en-us/license>. Hubungi <http://support.linksys.com/en-us/gplcodecenter> untuk pertanyaan atau permintaan kode sumber GPL.*

## Cara memasang router Anda

1. Untuk menyelesaikan pengaturan, Anda butuh komputer untuk membuka <http://LinksysSmartWiFi.com> pada browser web.
2. Kenali perlengkapan Anda.

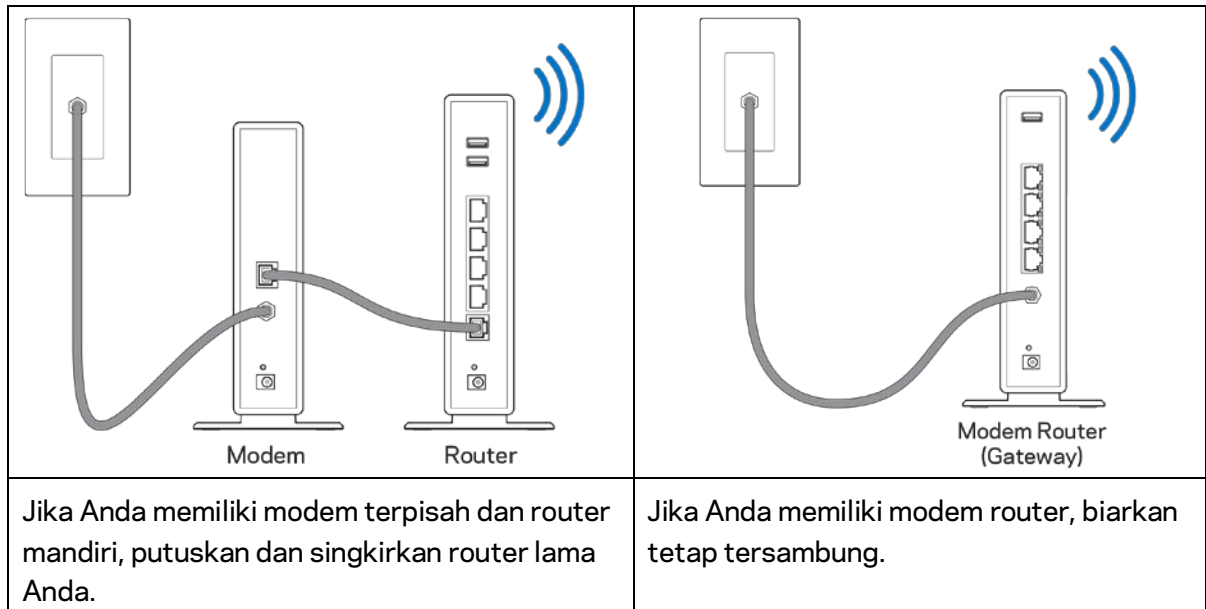

3. Posisikan antena tegak ke atas lalu colokkan router ke catu daya. Pastikan sakelar daya pada posisi | (hidup).
4. Sambungkan router ke modem atau modem router. Colokkan salah satu ujung kabel internet ke port Internet berwarna kuning pada router baru Anda. Jika Anda memiliki modem, colokkan ujung lainnya ke port Ethernet (LAN) pada modem. Jika Anda memiliki modem router, colokkan ke port mana pun yang tersedia.
5. Tunggu hingga lampu Linksys pada bagian atas router berhenti berkedip dan menyala putih terang.
6. Sambungkan ke nama Wi-Fi dalam Panduan Mulai Cepat yang disertakan bersama router Anda. (Anda dapat mengubah detail ini nanti.) Jika Anda perlu bantuan untuk menyambungkan ke jaringan, lihat dokumentasi perangkat Anda di [linksys.com/support/EA8300](http://linksys.com/support/EA8300).

**Catatan**—Anda tidak akan dapat mengakses internet hingga pengaturan router selesai.

7. Ketik <http://LinksysSmartWiFi.com> pada browser web. Ikuti instruksi di layar untuk menyelesaikan pengaturan router Anda. Anda juga dapat mengetikkan 192.168.1.1 dalam browser untuk memulai pengaturan.

Di akhir pengaturan, ikuti petunjuk di layar untuk mengatur akun Wi-Fi Pintar Linksys Anda, Gunakan Wi-Fi Pintar Linksys untuk mengonfigurasi router Anda dari komputer mana pun dengan sambungan Internet.

Mengelola pengaturan router Anda:

- Mengubah nama dan kata sandi router Anda
- Pengaturan akses tamu
- Mengonfigurasi Kendali Orang tua
- Menyambungkan perangkat ke Wi-Fi
- Menguji kecepatan sambungan Internet

**Catatan**—*Sebagai bagian dari pengaturan Wi-Fi Pintar Linksys, Anda akan dikirim email verifikasi. Dari jaringan asal Anda, klik tautan di dalam email tersebut untuk menautkan router Anda dengan akun Wi-Fi Pintar Linksys.*

**Tip**—*Cetak halaman setelah halaman ini, lalu catat pengaturan router dan akun Anda dalam tabel sebagai rujukan. Simpan catatan Anda di tempat yang aman.*

Nama Wi-Fi 2,4 GHz	
Kata Sandi Wi-Fi	
Nama Wi-Fi 5 GHz <sub>1</sub>	
Kata Sandi Wi-Fi	
Nama Wi-Fi 5 GHz <sub>2</sub>	
Kata Sandi Wi-Fi	
Kata Sandi Router	
Nama Jaringan Tamu 2,4 GHz	
Nama Jaringan Tamu 5GHz	
Sandi Wi-Fi Jaringan Tamu (Keduanya berbagi sandi.)	
Nama pengguna Wi-Fi Pintar Linksys	
Kata Sandi Wi-Fi Pintar Linksys	



# Cara Menggunakan Wi-Fi Pintar Linksys

Anda dapat mengelola router dari belahan bumi mana pun dengan menggunakan Wi-Fi Pintar Linksys, tetapi Anda juga dapat melakukannya langsung dari jaringan asal Anda. Wi-Fi Pintar Linksys mungkin juga tersedia untuk perangkat seluler Anda. Lihat toko aplikasi perangkat Anda untuk informasi.

## Cara menyambungkan ke Wi-Fi Pintar Linksys

Untuk menyambungkan ke Wi-Fi Pintar Linksys:

1. Buka browser web komputer Anda.
2. Buka <http://LinksysSmartWiFi.com> lalu masuk ke akun Anda.

Linksys Smart Wi-Fi Sign In

If you have not yet created a Linksys Smart Wi-Fi account, click the "Create Account" button in the upper right corner of the page.

Give guests Internet access

Use your Linksys Smart Wi-Fi account to access your home network from anywhere, at any time, even from your mobile device. Easily connect new devices, set parental controls, get access to Smart Wi-Fi mobile Apps, and more.

For more information [click here](#)

English (United States)

For local access, [click here](#).

Jika Anda tidak dapat mengingat kata sandi Anda, klik *Lupa kata sandi Anda?* lalu ikuti petunjuk di layar untuk memulihkannya.

## Peta Jaringan

Memungkinkan Anda menampilkan dan mengelola semua perangkat jaringan yang tersambung ke router. Anda dapat melihat perangkat di jaringan utama dan jaringan tamu, atau menampilkan informasi mengenai masing-masing perangkat.



## Akses Tamu

Memungkinkan Anda mengatur dan memantau jaringan untuk tamu untuk mengakses Wi-Fi tanpa memaparkan informasi pribadi.

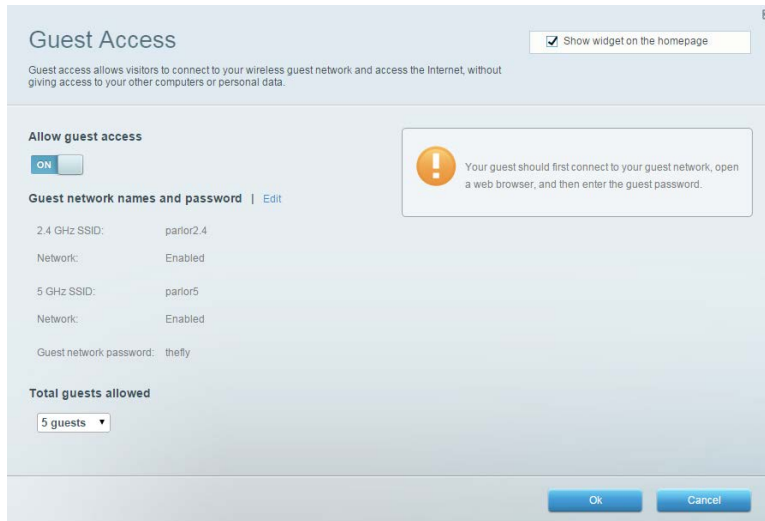

## Kendali Orang Tua

Memungkinkan Anda memblokir situs web dan mengatur waktu akses internet.

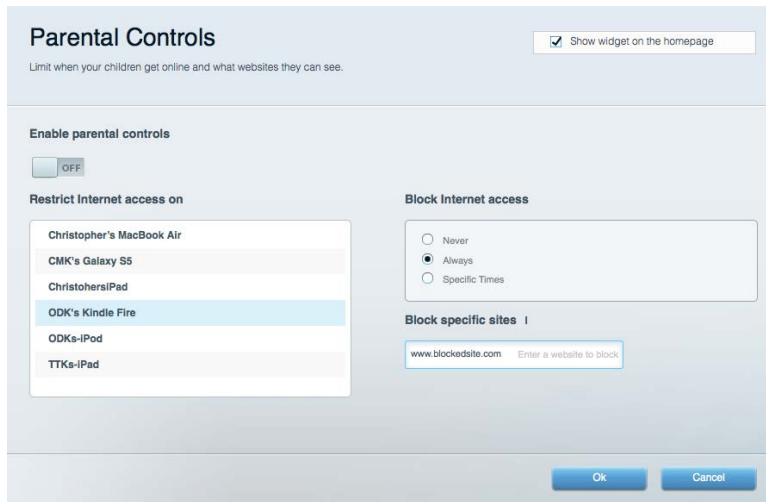

## Prioritas Media

Memungkinkan Anda mengatur perangkat dan aplikasi yang diberikan prioritas teratas untuk trafik jaringan.

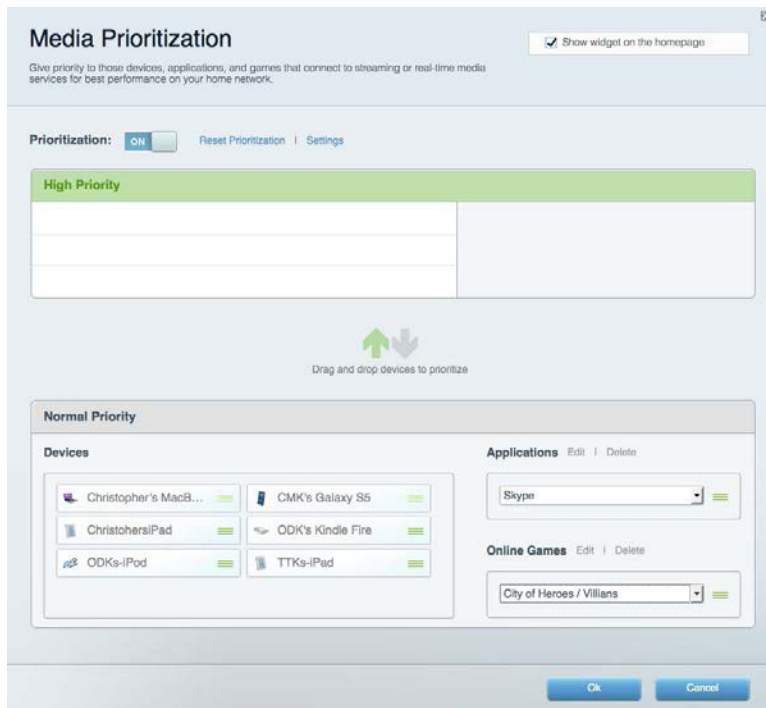

## Uji Kecepatan

Memungkinkan Anda menguji kecepatan sambungan Internet.



## Penyimpanan Eksternal

Memungkinkan Anda mengakses drive USB (tidak disertakan) dan mengatur berbagi file, server media, dan akses FTP.



## Konektivitas

Memungkinkan Anda melihat dan mengubah pengaturan jaringan dasar dan tingkat lanjut.

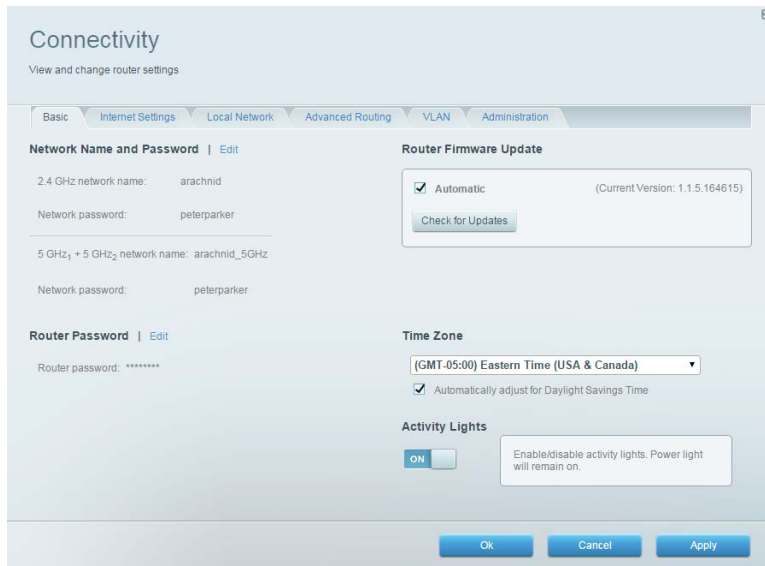

## Pemecahan Masalah

Memungkinkan Anda mendiagnosis masalah pada router dan memeriksa status jaringan.

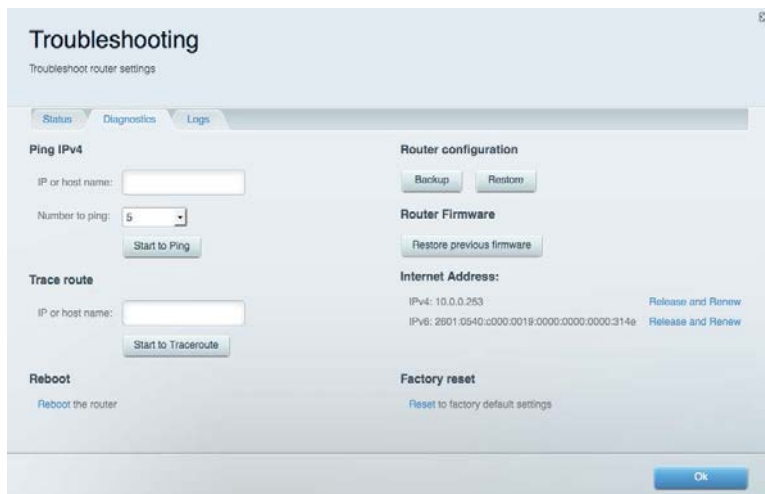

## Nirkabel

Memungkinkan Anda melihat dan mengubah jaringan nirkabel router. Anda dapat mengubah nama jaringan, mode keamanan, kata sandi, pemfilteran MAC, dan menyambungkan perangkat menggunakan Tombol Wi-Fi Protected Setup.

Wireless

View and change router settings

Wireless | MAC Filtering | Wi-Fi Protected Setup

Smart Connect:  5 GHz band steering (5 GHz<sub>1</sub> + 5 GHz<sub>2</sub>)  Off (Individual networks) What is Smart Connect band steering?

Network name: arachnid 2.4 GHz Network:  ON

Password: peterparker Broadcast SSID: Yes Channel: Auto

Security mode: WPA2/WPA Mixed Pe Network mode: Mixed Channel width: Auto

Network name: arachnid\_5GHz 5 GHz<sub>1</sub> + 5 GHz<sub>2</sub> Network:  ON

Password: peterparker Broadcast SSID: Yes Channel: Auto

Security mode: WPA2/WPA Mixed Pe Network mode: Auto Channel width: Auto

Ok Cancel Apply

## Keamanan

Memungkinkan Anda melihat dan mengubah keamanan jaringan nirkabel router. Anda dapat mengatur firewall, pengaturan VPN dan membuat pengaturan kustom untuk aplikasi dan permainan.

Security

View and change router settings

Firewall | DMZ | Apps and Gaming

**Firewall**

IPv4 SPI firewall protection  Enabled

IPv6 SPI firewall protection  Enabled

**Internet filters**

Filter anonymous Internet requests

Filter multicast

Filter Internet NAT redirection

Filter ident (Port 113)

**VPN Passthrough**

IPSec Passthrough  Enabled

PPTP Passthrough  Enabled

L2TP Passthrough  Enabled

**IPv6 Port Services**

Description	Protocol	IPv6 Address	Allow	Enabled

Add IPv6 Firewall Setting

Ok Cancel Apply

# Pemecahan Masalah

Anda dapat menemukan bantuan lebih lanjut dari dukungan pelanggan kami yang telah meraih penghargaan di [linksys.com/support/EA8300](https://linksys.com/support/EA8300).

## Pengaturan router Anda tidak berhasil

Jika Wi-Fi Pintar Linksys tidak menyelesaikan pengaturan, Anda dapat mencoba hal berikut:

- Dengan menggunakan klip kertas atau peniti, tekan terus tombol Atur Ulang sampai lampu logo Linksys mati dan indikator biru MU-MIMO mulai berkedip (sekitar 10 detik). Pasang kembali router.

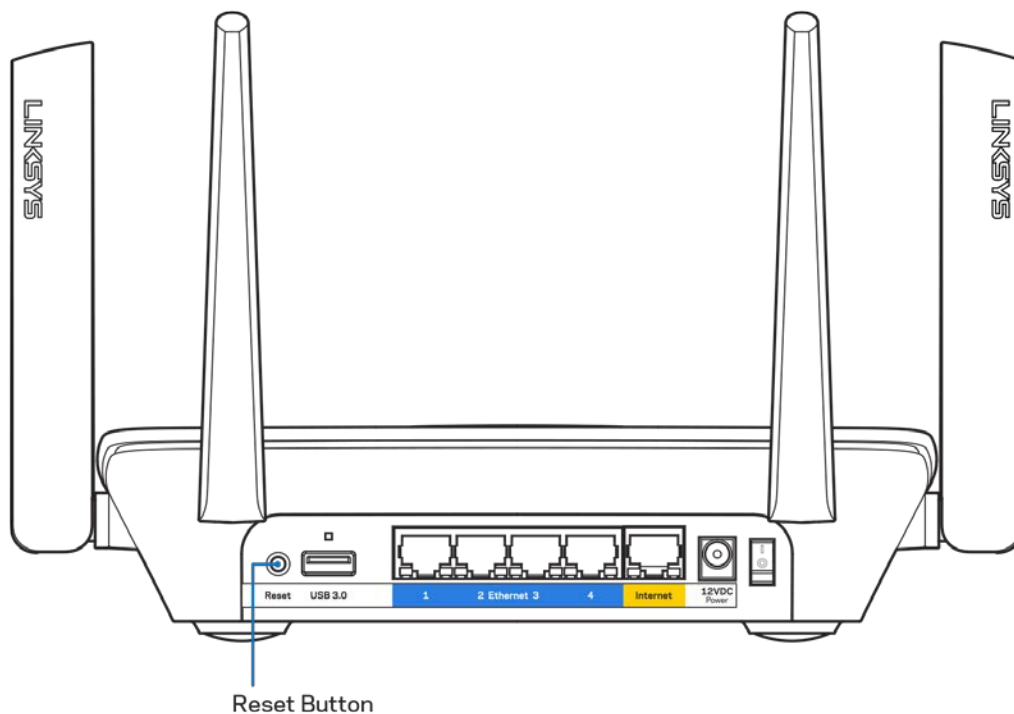

- Untuk sementara nonaktifkan firewall komputer Anda (lihat petunjuk perangkat lunak keamanan untuk mendapatkan bantuan). Pasang kembali router.
- Jika Anda memiliki komputer lain, gunakan komputer tersebut untuk memasang kembali router.

## Pesan *kabel Internet Anda tidak tersambung*

Jika Anda mendapat pesan "Kabel Internet Anda tidak tersambung" saat mencoba mengatur router, ikuti langkah-langkah pemecahan masalah berikut.

- Pastikan kabel ethernet atau internet (atau kabel seperti yang disertakan bersama router Anda) tersambung dengan kuat ke port Internet berwarna kuning di bagian belakang router dan pada port yang sesuai dengan modem. Port ini pada modem biasanya bertuliskan Ethernet.

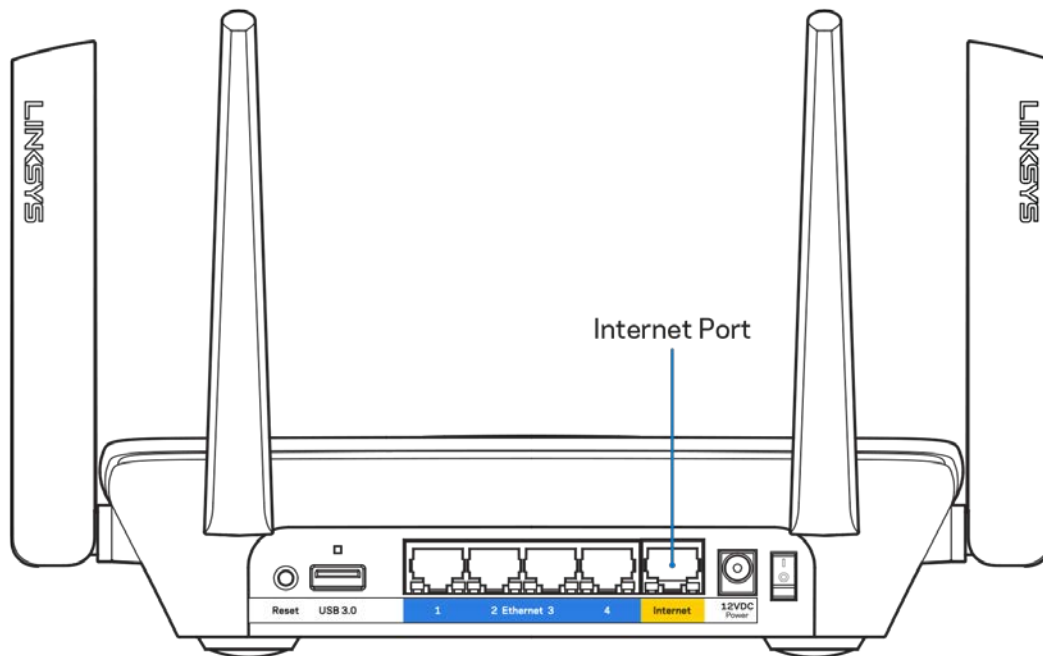

- Pastikan bahwa modem Anda telah tersambung ke daya dan telah dihidupkan. Jika modem memiliki sakelar daya, pastikan posisinya diatur ke HIDUP atau I (sebagai kebalikan dari O).

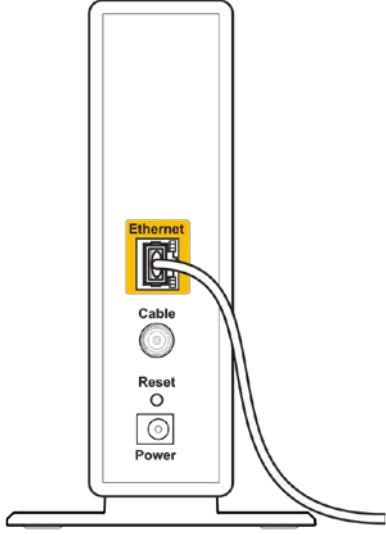
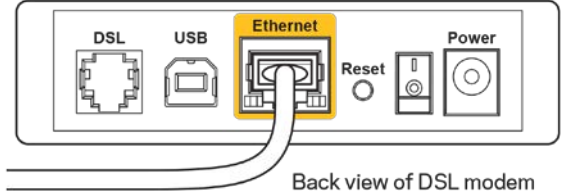

 <p style="text-align: center;">Back view of cable modem</p>	 <p style="text-align: center;">Back view of DSL modem</p>
<p>Jika layanan internet Anda melalui kabel, pastikan bahwa port CABLE pada modem kabel tersambung ke kabel koaksial yang disediakan oleh ISP Anda.</p>	<p>jika layanan Internet Anda adalah DSL, pastikan bahwa saluran telepon DSL tersambung ke port DSL pada modem.</p>

- Jika komputer Anda sebelumnya tersambung ke modem menggunakan kabel USB, lepaskan kabel USB tersebut,
- Pasang kembali router.

## ***Pesan Tidak dapat mengakses router Anda***

Untuk mengakses router, Anda harus tersambung ke jaringan Anda sendiri. Jika Anda memiliki akses internet nirkabel, penyebabnya mungkin karena Anda tidak sengaja tersambung ke jaringan nirkabel yang berbeda.

Untuk memperbaiki masalah pada komputer berbasis Windows, lakukan hal berikut\*:

1. Klik ikon nirkabel di baki sistem. Daftar jaringan yang tersedia akan muncul.

2. Klik nama jaringan Anda sendiri. Klik Sambungkan. Dalam contoh di bawah ini, komputer telah tersambung ke jaringan nirkabel lain bernama wraith\_5GHz. Nama jaringan nirkabel dari router Linksys EA8300, dalam contoh ini, Damaged\_Beez2.4 yang dipilih.



3. Jika Anda diminta untuk memasukkan kunci pengaman jaringan, ketikkan kata sandi Anda (kunci pengaman) ke dalam bidang *kunci pengaman jaringan*. Klik **OK**.
4. Komputer Anda akan tersambung ke jaringan, dan sekarang router tersebut dapat Anda akses.

*\*Bergantung pada versi Windows Anda, mungkin ada beberapa perbedaan dalam penulisan atau ikon pada langkah ini.*

Untuk memperbaiki masalah pada komputer berbasis Mac, lakukan hal berikut:

1. Dalam bilah menu di bagian atas layar, klik ikon Wi-Fi. Daftar jaringan nirkabel akan muncul.
2. Dalam contoh di bawah ini, komputer telah tersambung ke jaringan nirkabel lain bernama wraith\_5GHz. Nama jaringan nirkabel dari router Linksys EA8300, dalam contoh ini, Damaged\_Beez2.4 yang dipilih.

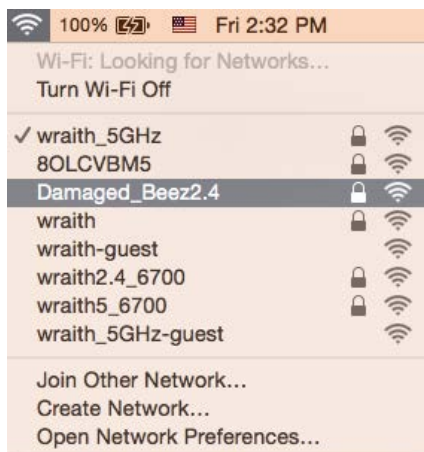

3. Klik nama jaringan nirkabel router Linksys EA8300 Anda (Damaged\_Beez2.4 dalam contoh).
4. Ketikkan kata sandi jaringan nirkabel (Kunci Keamanan) ke dalam bidang *Kata Sandi*. Klik **OK**.

## Setelah pengaturan

### Internet sepertinya tak tersedia

Jika internet kesulitan berkomunikasi dengan router Anda, masalahnya mungkin muncul sebagai pesan "Tidak dapat menemukan [alamat internet]" pada browser web Anda. Jika Anda tahu bahwa alamat Internet tersebut benar, dan jika Anda telah mencoba beberapa alamat Internet yang sah dengan hasil yang sama, pesan tersebut berarti mungkin ada masalah dengan ISP atau modem yang berkomunikasi dengan router Anda. Coba lakukan hal berikut:

- Pastikan kabel jaringan dan daya terpasang dengan kuat.
- Pastikan stopkontak tempat router disambungkan memiliki daya.
- Booting ulang router Anda.
- Hubungi ISP dan tanyakan apakah ada putus jaringan di area Anda.

Metode pemecahan masalah yang paling umum untuk router Anda adalah mematikan, lalu menghidupkannya kembali. Router Anda kemudian dapat memuat ulang pengaturan kustom, dan perangkat lain (seperti modem) akan dapat menemukan kembali router serta berkomunikasi dengannya. Proses ini disebut booting ulang.

Untuk melakukan booting ulang router Anda menggunakan kabel daya, lakukan hal berikut:

1. Putuskan sambungan kabel daya dari router dan modem.
2. Tunggu 10 detik, lalu sambungkan kembali kabel daya ke modem. Pastikan modem mendapatkan daya.
3. Tunggu hingga indikator online modem berhenti berkedip (sekitar 2 menit). Sambungkan kembali kabel daya ke router.
4. Tunggu sampai lampu logo Linksys menyala. Tunggu 2 menit sebelum mencoba menyambung ke Internet dari komputer.

Untuk melakukan booting ulang router Anda menggunakan Wi-Fi Pintar Linksys, lakukan hal berikut:

1. Masuk ke Wi-Fi Pintar Linksys. (Lihat "Cara menyambungkan ke Wi-Fi Pintar Linksys" di halaman [11](#).)
2. Di dalam *Pengaturan Router*, klik *Pemecahan Masalah*.
3. Klik tab *Diagnostik*.

4. Di dalam *Booting ulang*, klik Booting ulang.



5. Klik **Ya**. Router akan melakukan booting ulang. Saat router melakukan booting ulang, semua perangkat yang tersambung akan kehilangan sambungan Internet, dan akan tersambung kembali secara otomatis saat router kembali tersedia.

## Wi-Fi Pintar Linksys tidak terbuka pada browser web Anda

Versi terbaru Google Chrome™, Firefox®, Safari® (untuk Mac® dan iPad®), Microsoft Edge, serta Internet Explorer® versi 8 dan yang lebih tinggi kompatibel dengan Wi-Fi Pintar Linksys.

# Spesifikasi

## Linksys EA8300

Nama Model	Tri-Band Router AC2200 MU-MIMO Max-Stream
Nomor Model	EA8300
Kecepatan Pengalihan Port	10/100/1000 Mbps (Gigabit Ethernet)
Frekuensi Radio	2,4 GHz dan 5 GHz (x2)
Jumlah Antena	4 x antena eksternal yang bisa disesuaikan (tidak dapat dilepas)
Port	USB 3.0, Ethernet (1-4), Internet, Daya
Tombol	Wi-Fi Protected Setup, Daya, Atur Ulang
Lampu	<b>Panel atas:</b> Lampu logo Linksys , Wi-Fi Protected Setup, sambungan Internet, sambungan kabel jaringan ke port Internet <b>Panel belakang:</b> USB, Ethernet (1-4), Internet
UPnP	Didukung
Fitur Keamanan	WEP, WPA2, RADIUS
Bit Kunci Keamanan	Hingga enkripsi 128-bit
Dukungan Sistem File Penyimpanan	FAT, NTFS, dan HFS+
Dukungan Browser	Versi terbaru Google Chrome™, Firefox®, Safari® (untuk Mac® dan iPad®), Microsoft Edge, dan Internet Explorer® versi 8 atau yang lebih baru

## Lingkungan

Dimensi	213,7mm x 161,8mm x 54,8mm (tanpa antena)
Berat Unit	608 g
Daya	12V, 2A
Sertifikasi	FCC, IC, CE, Wi-Fi (a/b/g/n/ac)
Suhu Operasi	32 hingga 104°F (0 hingga 40°C)
Suhu Penyimpanan	-4 hingga 140°F (-20 hingga 60°C)
Kelembapan Operasi	10% hingga 80% kelembapan relatif, nonkondensasi
Kelembapan Penyimpanan	5% hingga 90%, nonkondensasi

Spesifikasi dapat berubah sewaktu-waktu tanpa pemberitahuan.

Catatan:

Untuk mengetahui peraturan, garansi, dan informasi keselamatan, lihat pada CD yang disertakan bersama router Anda atau kunjungi [Linksys.com/support/EA8300](http://Linksys.com/support/EA8300).

Kinerja maksimal diperoleh dari spesifikasi IEEE Standard 802.11. Kinerja sesungguhnya dapat bervariasi, termasuk kapasitas jaringan nirkabel yang lebih rendah, laju transfer data, rentang dan jangkauan. Kinerja tergantung pada banyak faktor, kondisi dan variabel, termasuk jarak dari titik akses, volume trafik jaringan, bahan konstruksi dan bangunan, sistem operasi yang digunakan, campuran produk nirkabel yang digunakan, interferensi dan kondisi lainnya yang merugikan.

BELKIN, LINKSYS dan banyak nama produk serta logo adalah merek dagang dari grup perusahaan Belkin. Merek dagang pihak ketiga yang disebutkan adalah milik dari masing-masing pemiliknya. Lisensi dan pemberitahuan untuk perangkat lunak pihak ketiga yang digunakan dalam produk ini dapat dilihat di sini: <http://support.linksys.com/en-us/license>. Hubungi <http://support.linksys.com/en-us/gplcodecenter> untuk pertanyaan atau permintaan kode sumber GPL.

© 2017 Belkin International, Inc. dan/atau afiliasinya. Hak cipta dilindungi undang-undang.

**LINKSYS®**

Guida per l'utente

**MAX-STREAM™  
MU-MIMO AC2200  
ROUTER TRI-BAND**

Modello EA8300

# Sommario

Descrizione del prodotto .....	3
Vista dall'alto.....	3
Indicatore di stato del sistema .....	4
Vista posteriore.....	5
Vista laterale .....	6
Installazione: operazioni basilari.....	7
Dove reperire ulteriori informazioni .....	7
Installazione del router .....	8
Come utilizzare Linksys Smart Wi-Fi .....	11
Per connettersi a Linksys Smart Wi-Fi.....	11
Mappa di rete .....	12
Accesso ospite .....	12
Filtro famiglia .....	13
Gestione intelligente delle priorità .....	13
Test della velocità .....	14
Archiviazione esterna .....	14
Connettività.....	15
Risoluzione dei problemi .....	15
Wireless.....	16
Protezione .....	16
Risoluzione dei problemi.....	17
L'installazione del router non è riuscita .....	17
Messaggio <i>Il cavo Internet non è collegato</i> .....	18
Messaggio <i>Impossibile accedere al router</i> .....	19
Al termine dell'installazione .....	21
Internet non è disponibile .....	21
Linksys Smart Wi-Fi non si apre nel browser web.....	22
Specifiche.....	23
Linksys EA8300 .....	23
Specifiche ambientali.....	23



# Descrizione del prodotto

## Vista dall'alto

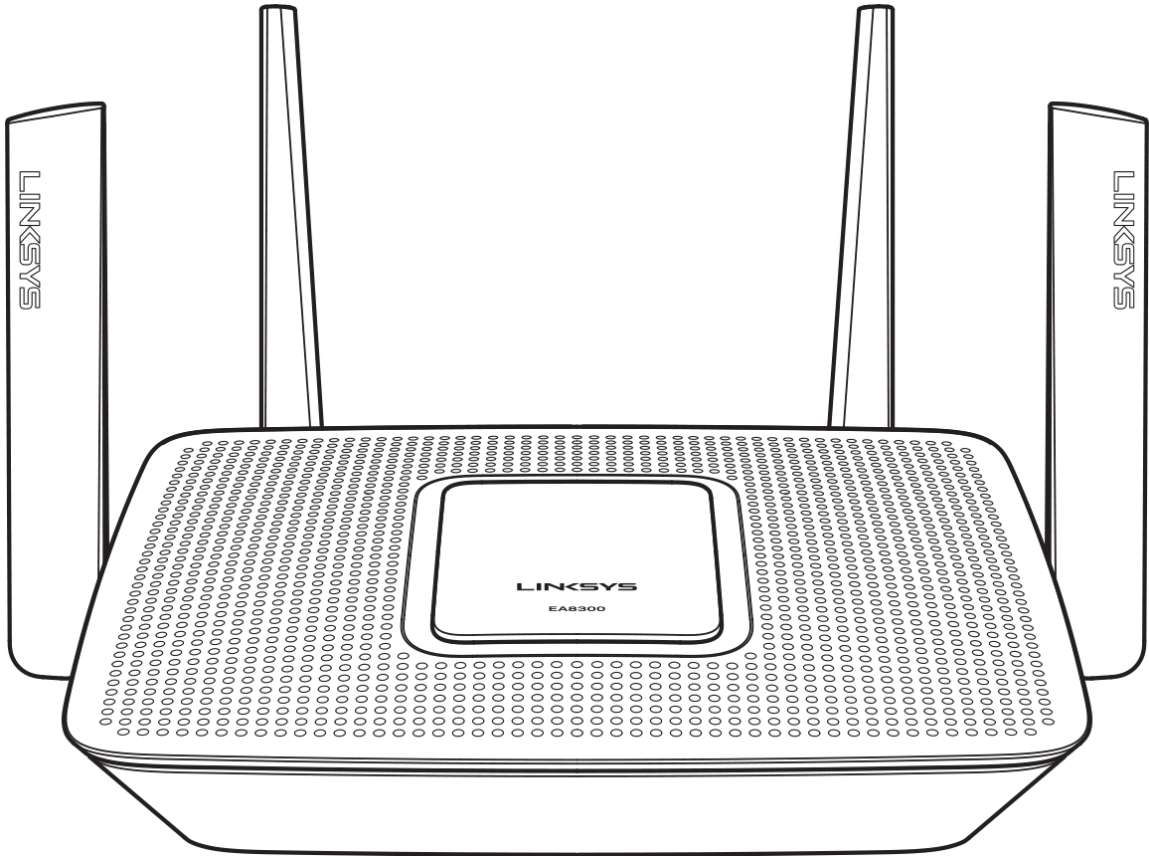

## Indicatore di stato del sistema

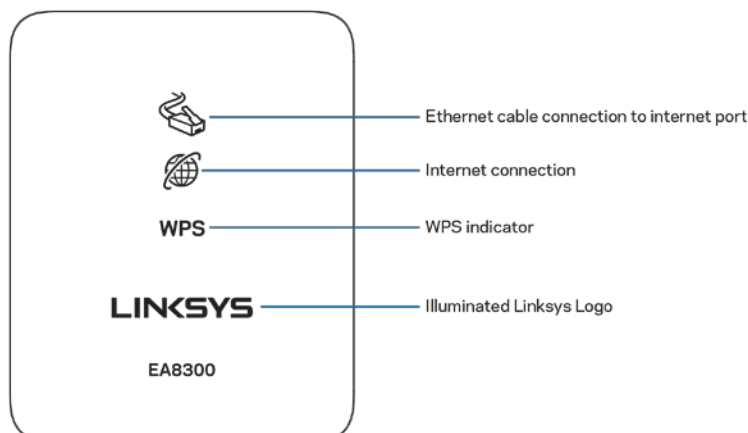

**Connessione del cavo Ethernet alla porta Internet** — Quando la spia luminosa è accesa (arancione), significa che vi è un problema con il cavo di rete connesso alla porta Internet (WAN).

**Connessione Internet** — Quando la spia luminosa è accesa (arancione), significa che il router non può accedere a Internet.

**Indicatore WPS (Wi-Fi Protected Setup™)** — L'indicatore WPS presenta quattro stati.

<b>Spento</b>	Nessuna attività Wi-Fi Protected Setup
<b>Bianco lampeggiante</b>	Procedura Wi-Fi Protected Setup in esecuzione
<b>Bianco fisso</b>	Procedura Wi-Fi Protected Setup riuscita con successo. Rimane acceso per 5 secondi
<b>Arancione lampeggiante</b>	Errore Wi-Fi Protected Setup. Si illumina per un minuto, quindi si spegne

**Logo Linksys illuminato** — Il logo si illumina quando il router è in fase di avvio. Quando il logo è di colore bianco fisso, il router è acceso e funziona correttamente.

## Vista posteriore

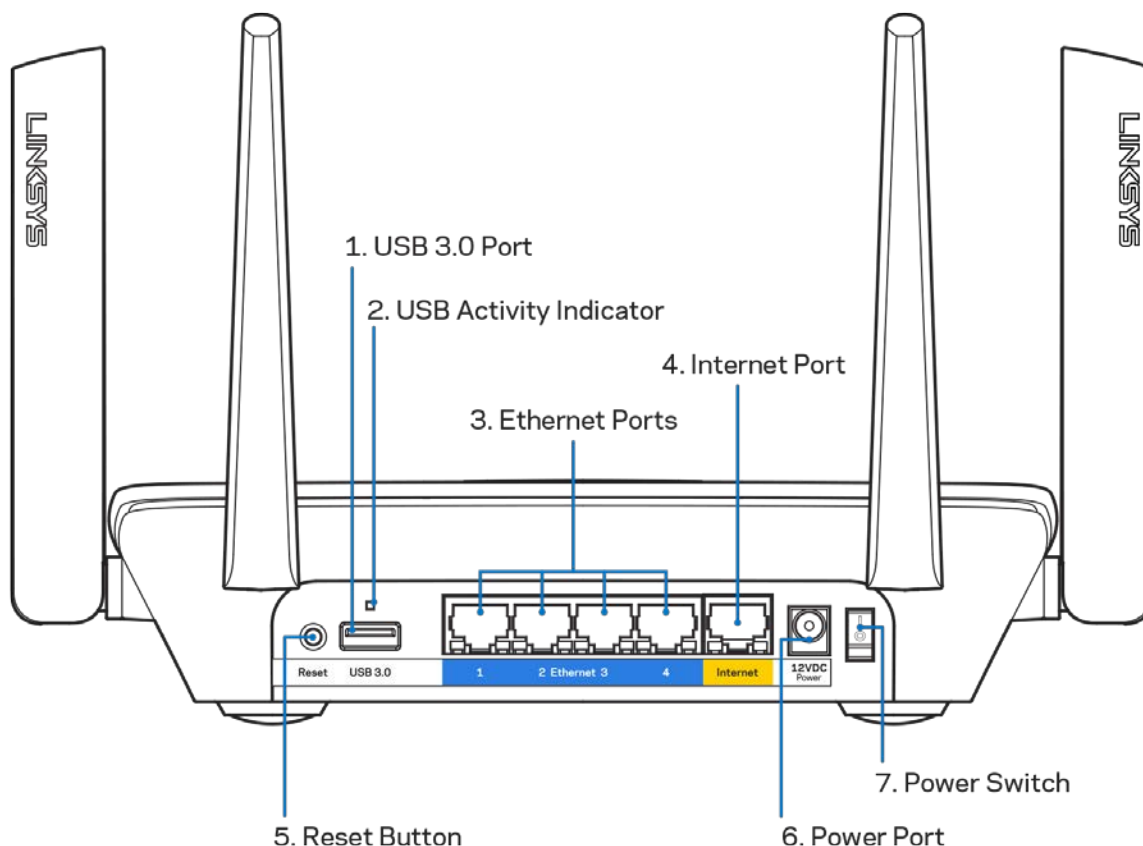

**Porta USB 3.0 (1)** — Per collegare e condividere dispositivi USB sulla rete o su Internet.

**Indicatore di attività USB (2)** — Le luci indicano il trasferimento dei dati da/verso dispositivi esterni.

**Porte Ethernet (3)** — Collegare i cavi Ethernet a queste porte Gigabit (10/100/1000) di colore blu e ai dispositivi cablati presenti sulla rete.

*Nota — Per prestazioni ottimali, utilizzare cavi di categoria CAT5e o superiore per collegare le porte Ethernet.*

**Porta Internet (4)** — Collegare un cavo Ethernet a questa porta Gigabit gialla (10/ 100/ 1000) e a un modem via cavo Internet a banda larga/DSL o a fibre ottiche.

*Nota — Per prestazioni ottimali, utilizzare un cavo di categoria CAT5e o superiore per la porta Internet.*

**Pulsante Reset (Ripristino) (5)** — Premere e tenere premuto fino a quando il logo Linksys illuminato non si spegne, per ripristinare il router ai valori di fabbrica. È possibile ripristinare le impostazioni predefinite utilizzando Linksys Smart Wi-Fi su Internet o tramite l'applicazione mobile.

**Porta di alimentazione (6)** — Collegare l'adattatore di alimentazione CA incluso.

**Interruttore di alimentazione (7)** — Premere | (on) per accendere il router.

## Vista laterale

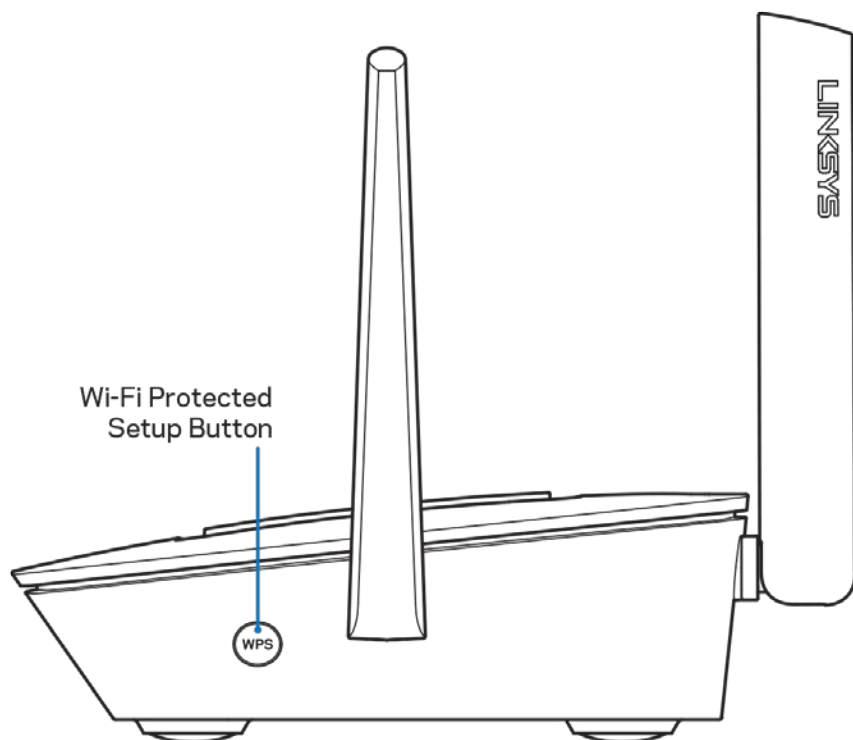

**Pulsante Wi-Fi Protected Setup™** — Premere per connettere i dispositivi di rete abilitati per la procedura WPS.

# Installazione: operazioni basilari

## Dove reperire ulteriori informazioni

Oltre a questa guida utente, è possibile recuperare ulteriori informazioni a questi indirizzi:

- [Linksys.com/support/EA8300](http://Linksys.com/support/EA8300) (documentazione, download, domande frequenti, assistenza tecnica, chat dal vivo, forum)
- Guida Linksys Smart Wi-Fi (connettersi a Linksys Smart Wi-Fi, quindi fare clic su Help (Guida) in alto sulla schermata principale)

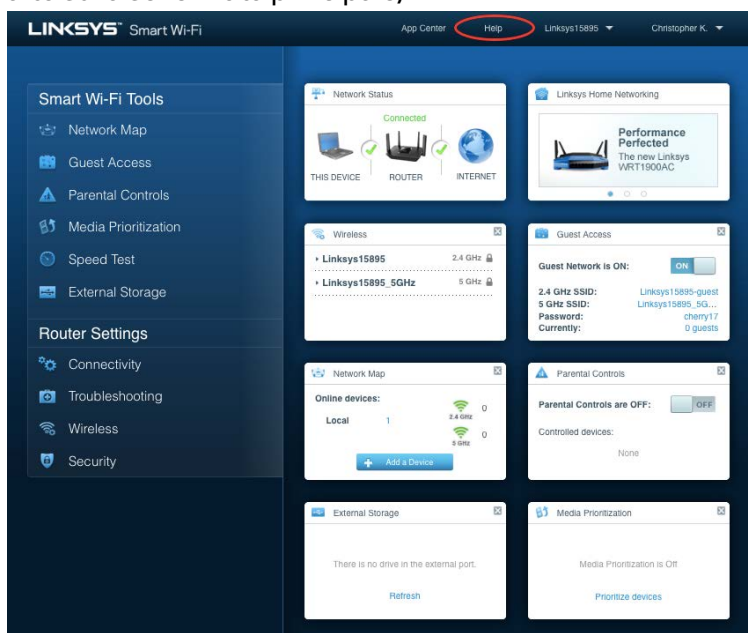

The screenshot shows the Linksys Smart Wi-Fi web interface. The top navigation bar includes 'App Center', 'Help' (circled in red), 'Linksys15895', and 'Christopher K.'. The main content area is divided into several sections: 'Smart Wi-Fi Tools' (Network Map, Guest Access, Parental Controls, Media Prioritization, Speed Test, External Storage), 'Router Settings' (Connectivity, Troubleshooting, Wireless, Security), and a central dashboard with widgets for Network Status, Linksys Home Networking, Wireless, Guest Access, Network Map, Parental Controls, External Storage, and Media Prioritization. A 'Help' modal window is open at the bottom, displaying the title 'Using Linksys Smart Wi-Fi' and a list of 'Help Categories' including 'Linksys Smart Wi-Fi', 'Device List', 'Guest Access', 'Parental Controls', 'Media Prioritization', 'Speed Test', and 'External Storage'. An 'Ok' button is visible at the bottom of the modal.

**Nota** — Licenze e notifiche, relative a software di terze parti utilizzati in questo prodotto, possono essere visualizzate all'indirizzo <http://support.linksys.com/en-us/license>. Contattare <http://support.linksys.com/en-us/gplcodecenter> per domande o richieste sul codice sorgente GPL.

## Installazione del router

1. Per completare l'installazione, è necessario un computer e visitare la pagina <http://LinksysSmartWiFi.com> aprendo un browser web.
2. Identificare la propria attrezzatura.

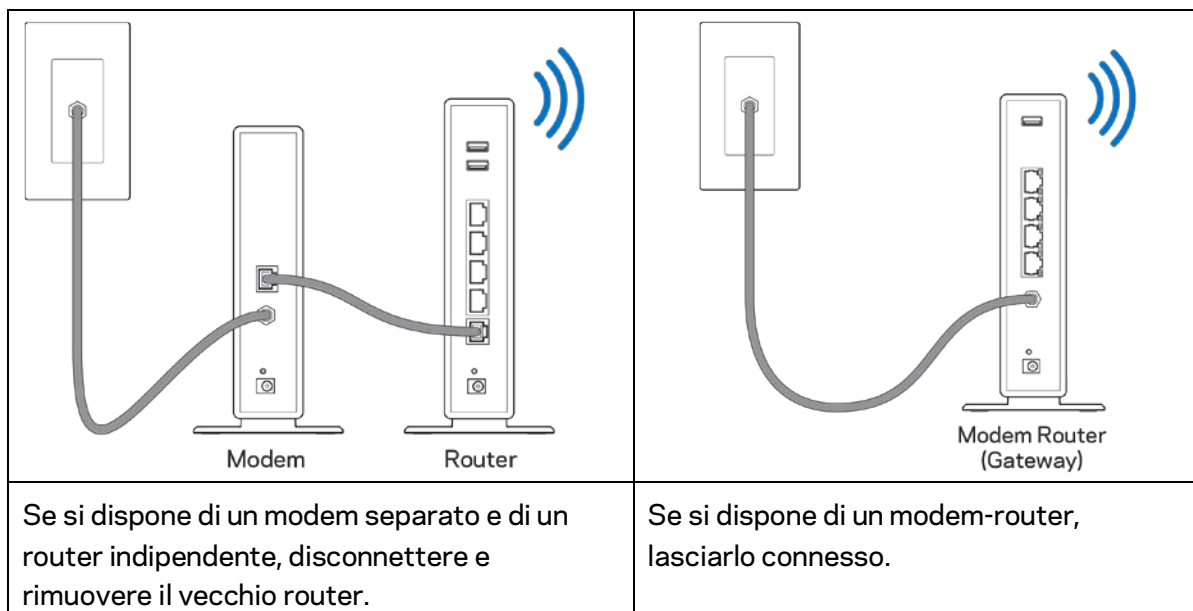

3. Posizionare le antenne verticalmente e collegare il router a una fonte di alimentazione. Accertarsi che l'interruttore di accensione sia nella posizione | (on).
4. Collegare il router al modem o al modem router. Inserire un'estremità del cavo Internet incluso nella porta Internet gialla sul nuovo router. Se si dispone di un modem, inserire l'altra estremità nella porta Ethernet (LAN) sul modem. Se si dispone di un modem-router, inserirla in qualsiasi porta disponibile.
5. Attendere che il LED Linksys illuminato sulla parte superiore del router termini di lampeggiare e diventi bianco fisso.
6. Connettersi al nome della rete Wi-Fi indicato nella Guida rapida fornita con il router. È possibile modificare questi dettagli più tardi. Se si necessita di aiuto per connettersi alla rete, consultare la documentazione del dispositivo all'indirizzo [linksys.com/support/EA8300](http://linksys.com/support/EA8300).

**Nota** — *l'accesso a Internet sarà disponibile solo dopo il completamento dell'installazione del router.*

7. Digitare <http://LinksysSmartWiFi.com> nel browser web. Seguire le istruzioni sullo schermo per completare l'installazione del router. Per avviare l'installazione è inoltre possibile digitare 192.168.1.1 in un browser.

Al termine del processo di installazione, seguire le istruzioni visualizzate sullo schermo per configurare l'account Linksys Smart Wi-Fi. Utilizzare Linksys Smart Wi-Fi per configurare il router da qualsiasi computer connesso a Internet.

Gestire le impostazioni del router:

- Modificare il nome e la password del router
- Configurare la funzione Accesso ospite
- Configurare la funzione Filtro famiglia
- Connettere i dispositivi alla rete Wi-Fi
- Verificare la velocità della connessione Internet

**Nota**—*Nel corso del processo di configurazione dell'account Linksys Smart Wi-Fi, l'utente riceverà un'e-mail di verifica. Dalla rete domestica, fare clic sul link nell'e-mail per associare il router all'account Linksys Smart Wi-Fi.*

**Suggerimento** — *Stampare la pagina successiva, quindi annotare le impostazioni del router e dell'account nella tabella per riferimenti futuri. Conservare le annotazioni in un luogo sicuro.*

Nome rete Wi-Fi da 2,4 GHz	
Password Wi-Fi	
Nome rete Wi-Fi 5 GHz <sub>1</sub>	
Password Wi-Fi	
Nome rete Wi-Fi 5 GHz <sub>2</sub>	
Password Wi-Fi	
Password del router	
Nome rete Wi-Fi ospite da 2,4 GHz	
Nome rete Wi-Fi ospite da 5 GHz	
Password della rete Wi-Fi ospite (entrambe condividono una password).	
Nome utente Linksys Smart Wi-Fi	
Password Linksys Smart Wi-Fi	



# Come utilizzare Linksys Smart Wi-Fi

È possibile gestire il router da qualsiasi parte del mondo, utilizzando Linksys Smart Wi-Fi, ma è possibile farlo anche direttamente dalla rete domestica. Linksys Smart Wi-Fi potrebbe essere disponibile anche per il proprio dispositivo mobile. Per ulteriori informazioni, visitare lo store delle app del proprio dispositivo.

## Per connettersi a Linksys Smart Wi-Fi

Per connettersi a Linksys Smart Wi-Fi:

1. Aprire il browser web del computer.
2. Visitare <http://LinksysSmartWiFi.com> ed effettuare l'accesso all'account.

Linksys Smart Wi-Fi Sign In

If you have not yet created a Linksys Smart Wi-Fi account, click the "Create Account" button in the upper right corner of the page.

Give guests Internet access

Use your Linksys Smart Wi-Fi account to access your home network from anywhere, at any time, even from your mobile device. Easily connect new devices, set parental controls, get access to Smart Wi-Fi mobile Apps, and more.

For more information click here

Email Address

Password

Remember Me  
Forgot your password?

Sign In

Don't have an account? Click here.

English (United States)

For local access, click here.

Se non si ricorda la password, fare clic su *Forgot your password?* (Password dimenticata?) e seguire le istruzioni sullo schermo per recuperarla.

## Mappa di rete

Consente di visualizzare e gestire tutti i dispositivi di rete collegati al router. È possibile visualizzare i dispositivi presenti sia nella rete principale che nella rete ospite, o visualizzare informazioni relative a ciascuno di essi.



## Accesso ospite

Permette di configurare e gestire una rete ospiti per consentire l'accesso al Wi-Fi, senza esporre le informazioni personali.

The screenshot shows the 'Guest Access' configuration page. At the top, there's a title 'Guest Access' and a checkbox 'Show widget on the homepage' which is checked. Below the title, it says 'Guest access allows visitors to connect to your wireless guest network and access the Internet, without giving access to your other computers or personal data.' There are two main sections: 'Allow guest access' with a toggle switch set to 'ON', and 'Guest network names and password | Edit'. The 'Guest network names and password' section has two rows: '2.4 GHz SSID: parlor2.4' and '5 GHz SSID: parlor5', both with 'Network: Enabled'. Below that, 'Guest network password: thefly'. At the bottom, 'Total guests allowed' is set to '5 guests' with a dropdown arrow. There are 'OK' and 'Cancel' buttons at the bottom right. A warning box on the right says: 'Your guest should first connect to your guest network, open a web browser, and then enter the guest password.'

## Filtro famiglia

Consente di bloccare siti web e di impostare gli orari di accesso a Internet.

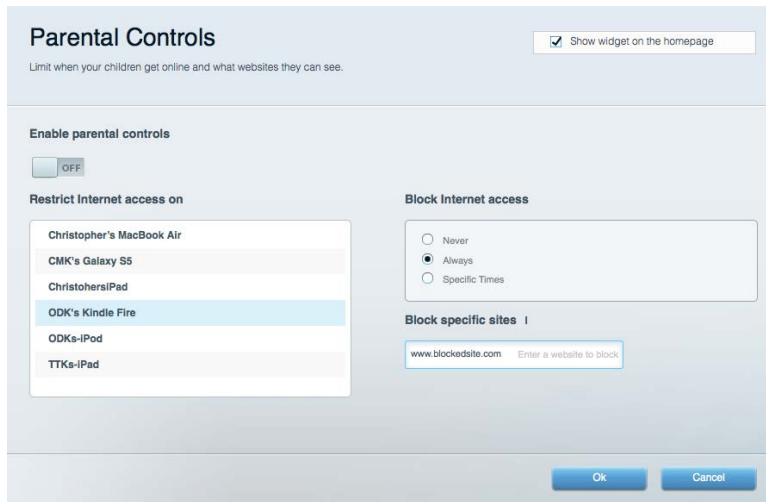

## Gestione intelligente delle priorità

Consente di decidere a quali dispositivi e applicazioni assegnare la priorità più alta per il traffico di rete.

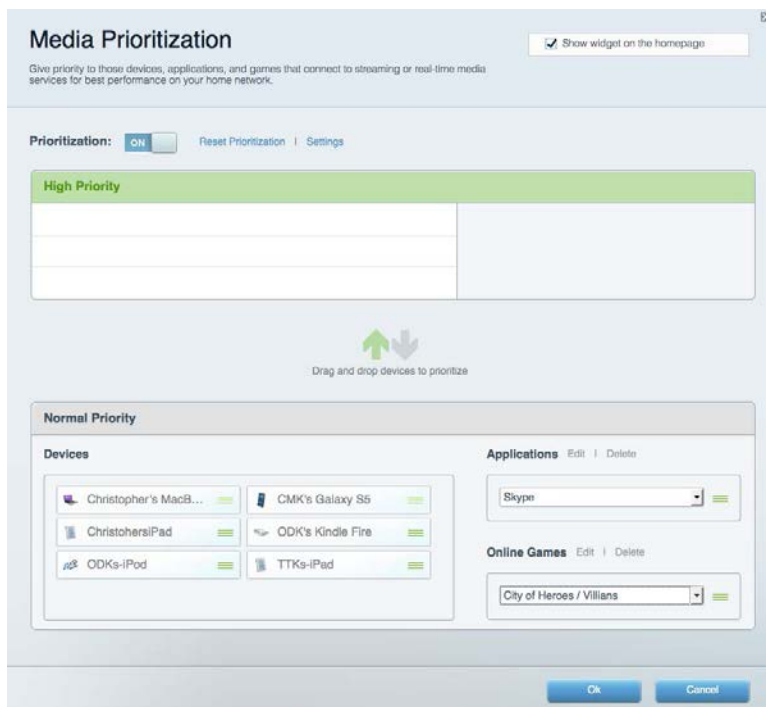

## Test della velocità

Consente di verificare la velocità della connessione Internet della rete.



## Archiviazione esterna

Consente di accedere a un disco USB collegato (non incluso) e di impostare la condivisione di file, un server multimediale e l'accesso FTP.

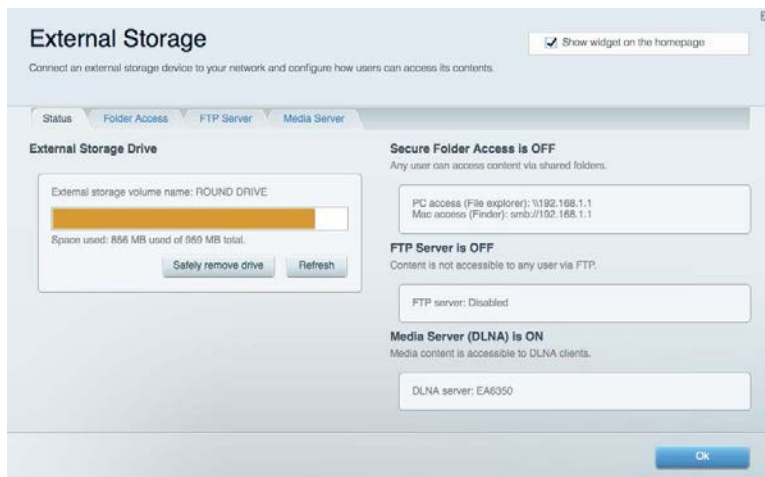

## Connettività

Consente di visualizzare e modificare impostazioni di rete standard e avanzate.

The screenshot shows the 'Connectivity' settings page of a router. It features a navigation bar with tabs for 'Basic', 'Internet Settings', 'Local Network', 'Advanced Routing', 'VLAN', and 'Administration'. The 'Internet Settings' tab is active. The page is divided into several sections: 'Network Name and Password' with fields for 2.4 GHz and 5 GHz network names and passwords; 'Router Password' with a masked password field; 'Router Firmware Update' with a checked 'Automatic' option and a 'Check for Updates' button; 'Time Zone' with a dropdown menu set to '(GMT-05:00) Eastern Time (USA & Canada)' and a checked 'Automatically adjust for Daylight Savings Time' option; and 'Activity Lights' with an 'ON' toggle and a descriptive text box. At the bottom, there are 'Ok', 'Cancel', and 'Apply' buttons.

## Risoluzione dei problemi

Consente di diagnosticare i problemi relativi al router e di verificare lo stato della rete.

The screenshot shows the 'Troubleshooting' settings page of a router. It features a navigation bar with tabs for 'Status', 'Diagnostics', and 'Logs'. The 'Diagnostics' tab is active. The page is divided into several sections: 'Ping IPv4' with input fields for IP or host name and number of pings, and a 'Start to Ping' button; 'Trace route' with an input field for IP or host name and a 'Start to Traceroute' button; 'Reboot' with a 'Reboot the router' link; 'Router configuration' with 'Backup' and 'Restore' buttons; 'Router Firmware' with a 'Restore previous firmware' button; 'Internet Address' showing IPv4 (10.0.0.253) and IPv6 (2601:0540::000:0019:0000:0000:0000:314e) addresses with 'Release and Renew' links; and 'Factory reset' with a 'Reset to factory default settings' link. At the bottom, there is an 'Ok' button.

## Wireless

Permette di visualizzare e modificare la rete wireless del router. È possibile modificare i nomi della rete, la modalità di protezione, la password e il filtraggio MAC, nonché collegare i dispositivi utilizzando Wi-Fi Protected Setup.

The screenshot shows the 'Wireless' settings page. At the top, there is a 'Show widget on the homepage' checkbox which is checked. Below this, there are tabs for 'Wireless', 'MAC Filtering', and 'Wi-Fi Protected Setup'. The 'Smart Connect' section has two radio buttons: '5 GHz band steering' (selected) and 'Off'. Below this, there are two network configuration sections. The first section is for the 2.4 GHz network, with the name 'arachnid', password 'peterparker', and security mode 'WPA2/WPA Mixed'. The second section is for the 5 GHz network, with the name 'arachnid\_5GHz', password 'peterparker', and security mode 'WPA2/WPA Mixed'. At the bottom, there are 'Ok', 'Cancel', and 'Apply' buttons.

## Protezione

Permette di visualizzare e modificare la protezione wireless del router. È possibile configurare il firewall e le impostazioni VPN, e applicare impostazioni personalizzate per applicazioni e giochi.

The screenshot shows the 'Security' settings page. At the top, there are tabs for 'Firewall', 'DMZ', and 'Apps and Gaming'. The 'Firewall' section is active and contains several sub-sections: 'Firewall' with 'IPv4 SPI firewall protection' and 'IPv6 SPI firewall protection' both checked and enabled; 'VPN Passthrough' with 'IPSec Passthrough', 'PPTP Passthrough', and 'L2TP Passthrough' all checked and enabled; and 'Internet filters' with 'Filter anonymous Internet requests' checked and 'Filter ident (Port 113)' checked. Below these sections is an 'IPv6 Port Services' table with columns for 'Description', 'Protocol', 'IPv6 Address', 'Allow', and 'Enabled'. At the bottom, there are 'Ok', 'Cancel', and 'Apply' buttons.

Description	Protocol	IPv6 Address	Allow	Enabled

# Risoluzione dei problemi

Per l'assistenza, rivolgersi al nostro eccellente servizio clienti, all'indirizzo [linksys.com/support/EA8300](http://linksys.com/support/EA8300).

## L'installazione del router non è riuscita

Se Linksys Smart Wi-Fi non è riuscito a completare l'installazione, è possibile provare quanto segue:

- Premere e tenere premuto il pulsante Reset (Ripristino) sul router con una graffetta o uno spillo, fino a quando il logo Linksys illuminato si spegne e gli indicatori MU-MIMO blu iniziano a lampeggiare (circa 10 secondi). Reinstallare il router.

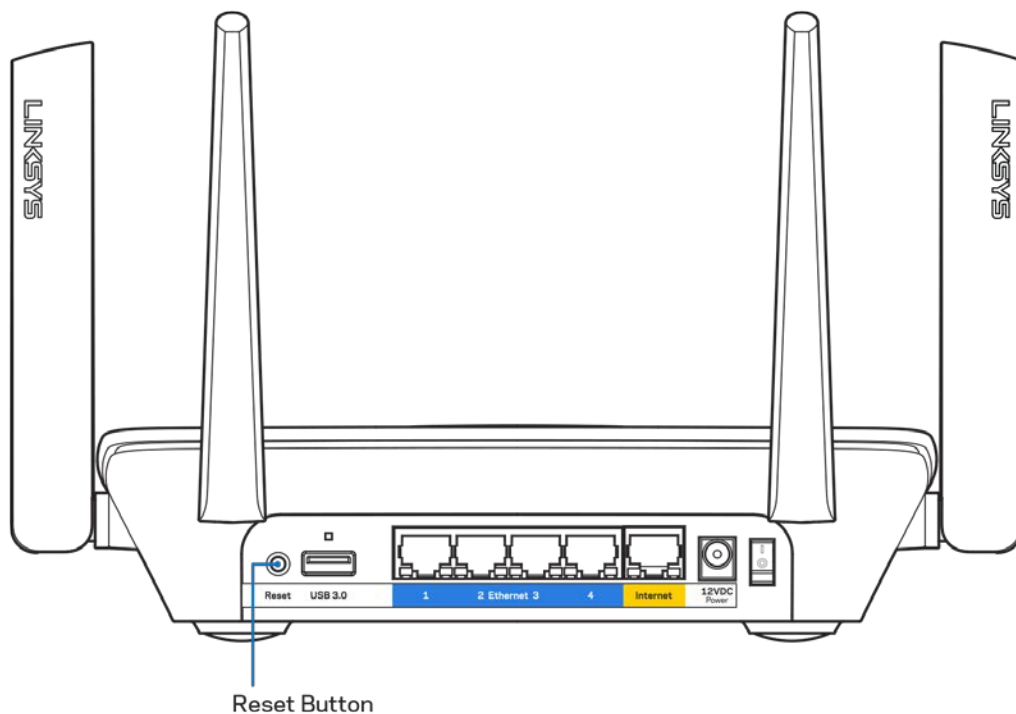

- Disattivare temporaneamente i firewall del computer (Consultare le istruzioni del software di protezione per un maggiore supporto). Reinstallare il router.
- Se si dispone di un altro computer, utilizzarlo per installare nuovamente il router.

## Messaggio // cavo Internet non è collegato

Se quando si installa il router si riceve il messaggio "Your Internet cable is not plugged in" (Il cavo Internet non è collegato), seguire queste fasi per risolvere il problema.

- Accertarsi che un cavo Ethernet o Internet (o un cavo come quello fornito con il proprio router) sia saldamente connesso alla porta Internet gialla sul retro del router e all'appropriata porta sul modem. Questa porta sul modem riporta di solito l'etichetta Ethernet.

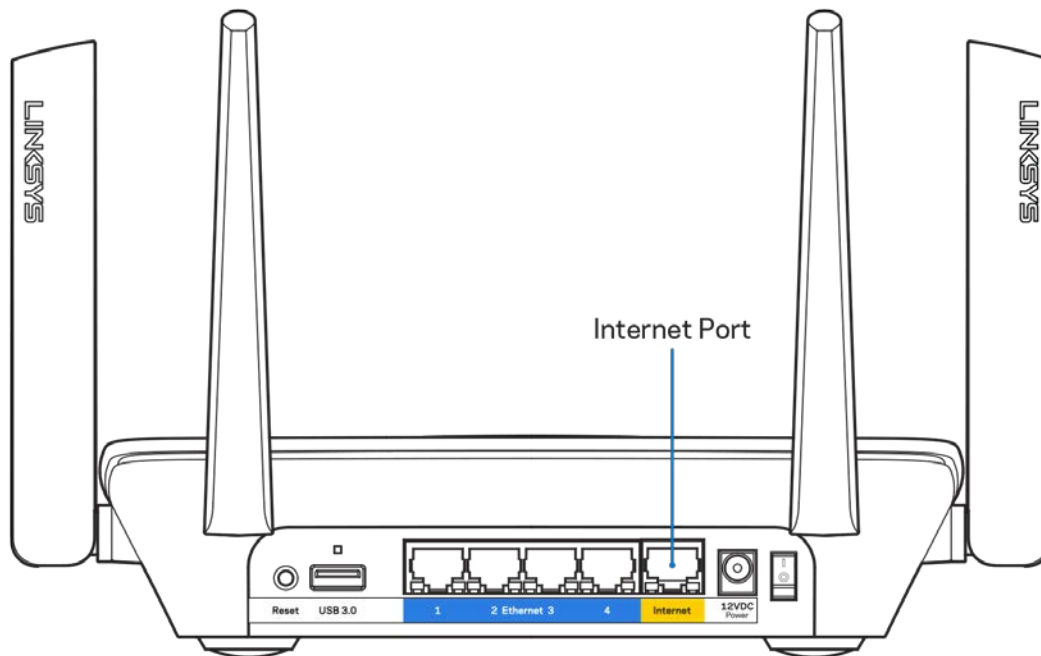

- Accertarsi che il modem sia collegato e che sia acceso. Se si dispone di un interruttore di alimentazione, assicurarsi che sia impostato sulla posizione ON o | (invece di O).

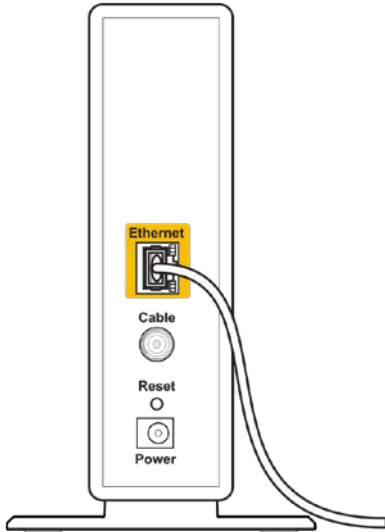
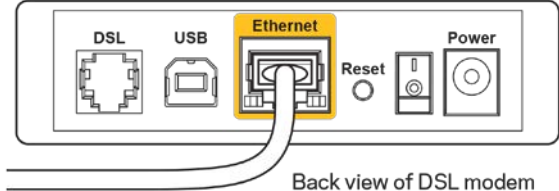

 <p>Back view of cable modem</p>	 <p>Back view of DSL modem</p>
<p>Se il servizio Internet è via cavo, verificare che la porta CABLE (Via cavo) del modem via cavo sia connessa al cavo coassiale fornito dal provider di servizi Internet.</p>	<p>Se il servizio Internet è DSL, accertarsi che la linea telefonica DSL sia connessa alla porta DSL del modem.</p>

- Se il computer è connesso al modem con un cavo USB, disconnettere il cavo USB.
- Reinstallare il router.

## Messaggio *Impossibile accedere al router*

Per accedere al router, è necessario essere connessi alla propria rete. Se si è connessi a una rete Internet wireless, il problema potrebbe essere che si è accidentalmente collegati a una rete wireless diversa dalla propria.

Per risolvere il problema su computer Windows, provare quanto segue:\*

1. Fare clic sull'icona wireless nell'area di notifica. Viene visualizzato un elenco delle reti disponibili.

2. Fare clic sul nome della propria rete. Fare clic su Connect (Connetti). Nell'esempio in basso, il computer era connesso ad un'altra rete wireless chiamata wraith\_5GHz. Il nome della rete wireless del router Linksys EA8300, Damaged\_Beez2.4 in questo esempio, è mostrato come selezionato.



3. Se viene richiesto di inserire una chiave di protezione della rete, digitare la password (chiave di protezione) nel campo della chiave di protezione della rete. Fare clic su **OK**.
4. Il computer si conetterà alla rete e sarà possibile accedere all'interfaccia delle impostazioni del router.

*\*A seconda della versione di Windows, potrebbero esserci alcune differenze nelle diciture o icone in queste fasi.*

Per risolvere il problema su computer Mac provare quanto segue:

1. Nella barra dei menu, in alto sullo schermo, fare clic sull'icona Wi-Fi. Comparirà l'elenco delle reti wireless.
2. Nell'esempio in basso, il computer era connesso ad un'altra rete wireless chiamata wraith\_5GHz. Il nome della rete wireless del router Linksys EA8300, Damaged\_Beez2.4 in questo esempio, è mostrato come selezionato.

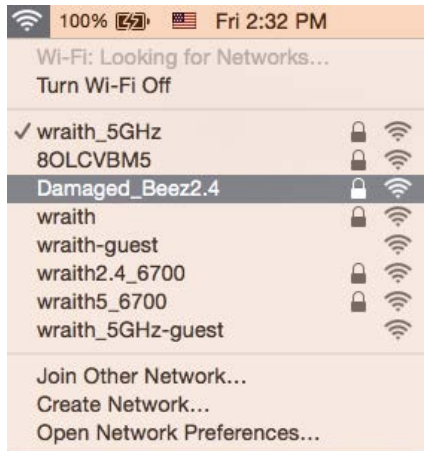

3. Fare clic sul nome della rete wireless del router Linksys EA8300 (Damaged\_Beez2.4 in questo esempio).
4. Digitare la password della rete wireless (Chiave di sicurezza) nel campo *Password*. Fare clic su **OK**.

## Al termine dell'installazione

### Internet non è disponibile

Se Internet sta avendo difficoltà a comunicare con il router, potrebbe comparire il messaggio "Impossibile trovare [sito Internet]" nel browser web. Se si è certi che l'indirizzo Internet sia corretto, e se sono stati provati diversi indirizzi Internet validi e si sono ottenuti gli stessi risultati, il messaggio potrebbe indicare un problema di comunicazione tra l'ISP o il modem e il router. Prova quanto segue:

- Accertarsi che i cavi di rete e di alimentazione siano connessi correttamente.
- Accertarsi che la presa di corrente al quale il router è collegato sia funzionante.
- Riavviare il router.
- Contattare il proprio provider di servizi Internet per verificare l'eventuale presenza di interruzioni del servizio nella propria zona.

Il metodo più comune per risolvere i problemi con il router è quello di spegnerlo e riavviarlo. Il router è in grado di ricaricare impostazioni personalizzate e gli altri dispositivi (come il modem) saranno in grado di rilevare nuovamente il router e di stabilire di nuovo la comunicazione. Questo processo è noto come riavvio.

Per riavviare il router utilizzando il cavo di alimentazione, fare quanto segue:

1. Scollegare il cavo di alimentazione dal router e dal modem.
2. Attendi 10 secondi, quindi ricollega il cavo di alimentazione al modem. Accertarsi che sia acceso.
3. Attendere fino a quando la spia di stato online del modem termina di lampeggiare (circa 2 minuti). Ricollegare il cavo di alimentazione al router.

4. Attendi che il logo Linksys sia illuminato. Attendi 2 minuti prima di provare a connetterti a Internet da un computer.

Per riavviare il router utilizzando Linksys Smart Wi-Fi, fare quanto segue:

1. Accedere a Linksys Smart Wi-Fi. Consultare la sezione "Per connettersi a Linksys Smart Wi-Fi", alla pagina [11](#).
2. Sotto *Router Settings* (Impostazioni del router), fare clic su *Troubleshooting* (Risoluzione dei problemi).
3. Fare clic sulla scheda *Diagnostics* (Diagnostica).
4. *Sotto Reboot* (Riavvio), fare clic su *Reboot* (Riavvia).



5. Fare clic su **Yes** (Sì). Il router sarà riavviato. Durante il riavvio del router, tutti i dispositivi perderanno la connessione a Internet e si riconnetteranno automaticamente quando il router è pronto di nuovo.

## Linksys Smart Wi-Fi non si apre nel browser web

Le ultime versioni di Google Chrome™, Firefox®, Safari® (per Mac® e iPad®), Microsoft Edge e Internet Explorer® versione 8 e successive sono supportate da Linksys Smart Wi-Fi.

# Specifiche

## Linksys EA8300

Nome modello	Router Tri-Band MU-MIMO AC2200 Max-Stream
Numero modello	EA8300
Velocità porte switch	10/100/1000 Mbps (Gigabit Ethernet)
Frequenza radio	2,4 GHz e 5 GHz (x2)
N. di antenne	4 antenne esterne regolabili (non rimovibili)
Porte	USB 3.0, Ethernet (1-4), Internet, alimentazione
Pulsanti	Wi-Fi Protected Setup, alimentazione, Reset
Spie luminose	<b>Pannello superiore:</b> Linksys logo illuminato , Wi-Fi Protected Setup, connessione Internet, connessione con cavo di rete alla porta Internet <b>Pannello posteriore:</b> USB, Ethernet (1-4), Internet
UPnP	Supportato
Funzionalità di protezione	WEP, WPA2, RADIUS
Bit chiavi di sicurezza	Cifratura fino a 128 bit
Supporto file system di archiviazione	FAT, NTFS e HFS+
Supporto browser	Le più recenti versioni di Google Chrome™, Firefox®, Safari® (per Mac® e iPad®), Microsoft Edge e Internet Explorer® versione 8 e successive

## Specifiche ambientali

Dimensioni	213,7 mm x 161,8 mm x 54,8 mm (senza antenne)
Peso dell'unità	608 g
Alimentazione	12 V, 2 A
Certificazioni	FCC, IC, CE, Wi-Fi (a/b/g/n/ac)
Temperatura di esercizio	Da 0 a 40°C
Temperatura di stoccaggio	Da -20 a 60 °C
Umidità di esercizio	Umidità relativa dal 10% all'80%, senza condensa
Umidità di stoccaggio	Dal 5% al 90%, senza condensa

Le specifiche sono soggette a variazioni senza obbligo di preavviso.

Note:

Per informazioni sulle normative, la garanzia e la sicurezza, consultare il CD fornito con il router oppure visitare il sito [Linksys.com/support/EA8300](http://Linksys.com/support/EA8300).

Le prestazioni ottimali indicate per la connettività wireless si basano sulle specifiche IEEE Standard 802.11. Le prestazioni effettive possono variare e comportare una riduzione della capacità di rete wireless, velocità di trasmissione dei dati, portata e copertura del segnale. Le prestazioni dipendono da numerosi fattori, condizioni e variabili, quali la distanza dall'access point, il volume del traffico di rete, i materiali costruttivi impiegati, il sistema operativo utilizzato, il mix di prodotti wireless impiegato, interferenze e altre condizioni avverse.

BELKIN, LINKSYS e molti logotipi e nomi di prodotto sono marchi commerciali del gruppo aziendale Belkin. I marchi di terze parti menzionati appartengono ai rispettivi proprietari. Licenze e notifiche, relative a software di terze parti utilizzati in questo prodotto, possono essere visualizzate qui: <http://support.linksys.com/en-us/license>. Contattare <http://support.linksys.com/en-us/gplcodecenter> per domande o richieste sul codice sorgente GPL.

© 2017 Belkin International, Inc. e/o rispettive società collegate. Tutti i diritti riservati.

**LINKSYS**

Naudotojo vadovas

„MAX-STREAM™“

„AC2200 MU-MIMO“

TRIJŲ JUOSTŲ MARŠRUTO  
PARINKTUVAS

Modelis EA8300

# Turinys

Gaminio apžvalga.....	3
Vaizdas iš viršaus .....	3
Sistemos būsenos indikatorius .....	4
Vaizdas iš galo .....	5
Vaizdas iš šono.....	6
Nustatymas: pagrindinė informacija .....	7
Kur pateikiama daugiau pagalbos.....	7
Kaip prijungti maršruto parinktuvą .....	8
Kaip naudoti „Linksys Smart Wi-Fi“ .....	11
Kaip prijungti prie „Linksys Smart Wi-Fi“ .....	11
Tinklo žemėlapis.....	12
Svečio prieiga .....	12
Tėvų kontrolė .....	13
Medijos prioritizacija .....	13
Greičio bandymas.....	14
Išorinė saugykla .....	14
Jungiamumas .....	15
Trikčių nustatymas ir šalinimas .....	15
Belaidis ryšys .....	16
Sauga.....	16
Trikčių nustatymas ir šalinimas .....	17
Maršrutizatorius nustatytas nesėkmingai .....	17
Pranešimas <i>Your Internet cable is not plugged in</i> (apie neprijungtą interneto kabelį).....	18
Pranešimas <i>Cannot access your router</i> (nepavyko pasiekti maršrutizatoriaus) .....	19
Po sąrankos .....	21
Nėra interneto.....	21
„Linksys Smart Wi-Fi“ neatsidaro žiniatinklio naršyklėje.....	22
Techniniai duomenys .....	23
„Linksys EA8300“ .....	23
Aplinkos duomenys.....	23



# Gaminio apžvalga

## Vaizdas iš viršaus

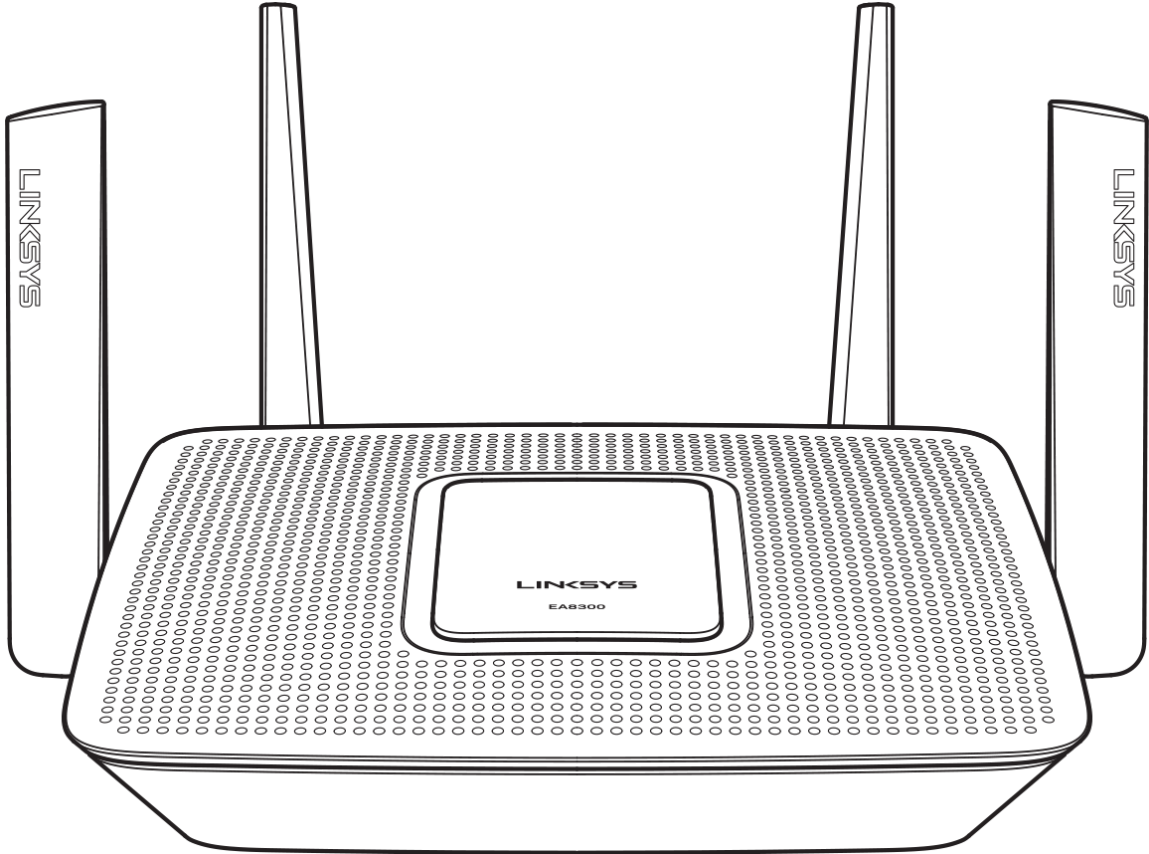

## Sistemos būsenos indikatoriai

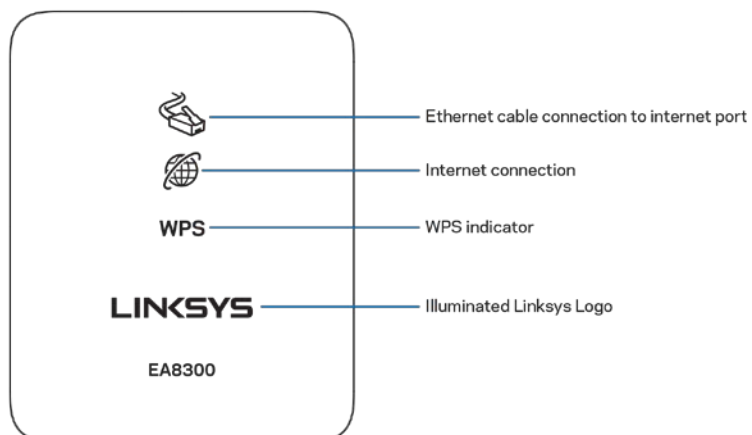

**Eterneto kabelio jungtis prie interneto prievado** – kai šviečia (oranžine spalva), rodo prie interneto (WAN) prievado prijungto tinklo kabelio problemą.

**Interneto jungtis** – kai šviečia (oranžine spalva), rodo, jog maršruto parinktuvui nepavyksta pasiekti tinklo.

**WPS („Wi-Fi Protected Setup™“) indikatorius** – WPS lemputė būna keturių būsenų:

<b>Nešviečia</b>	Nėra jokios „Wi-Fi Protected Setup“ veiklos
<b>Mirksi baltai</b>	Vyksta „Wi-Fi Protected Setup“
<b>Šviečia nepertraukiamai baltai</b>	„Wi-Fi Protected Setup“ atlikta sėkmingai; lieka šviesti penkias sekundes
<b>Mirksi oranžine spalva</b>	„Wi-Fi Protected Setup“ klaida; mirksi vieną minutę, tada užgęsta

**Apšviestas „Linksys“ logotipas** logotipas mirksi, kol maršruto parinktuvas paleidžiamas. Kai logotipas apšviestas pastoviai balta spalva, maršruto parinktuvas įjungtas ir veikia tinkamai.

## Vaizdas iš galo

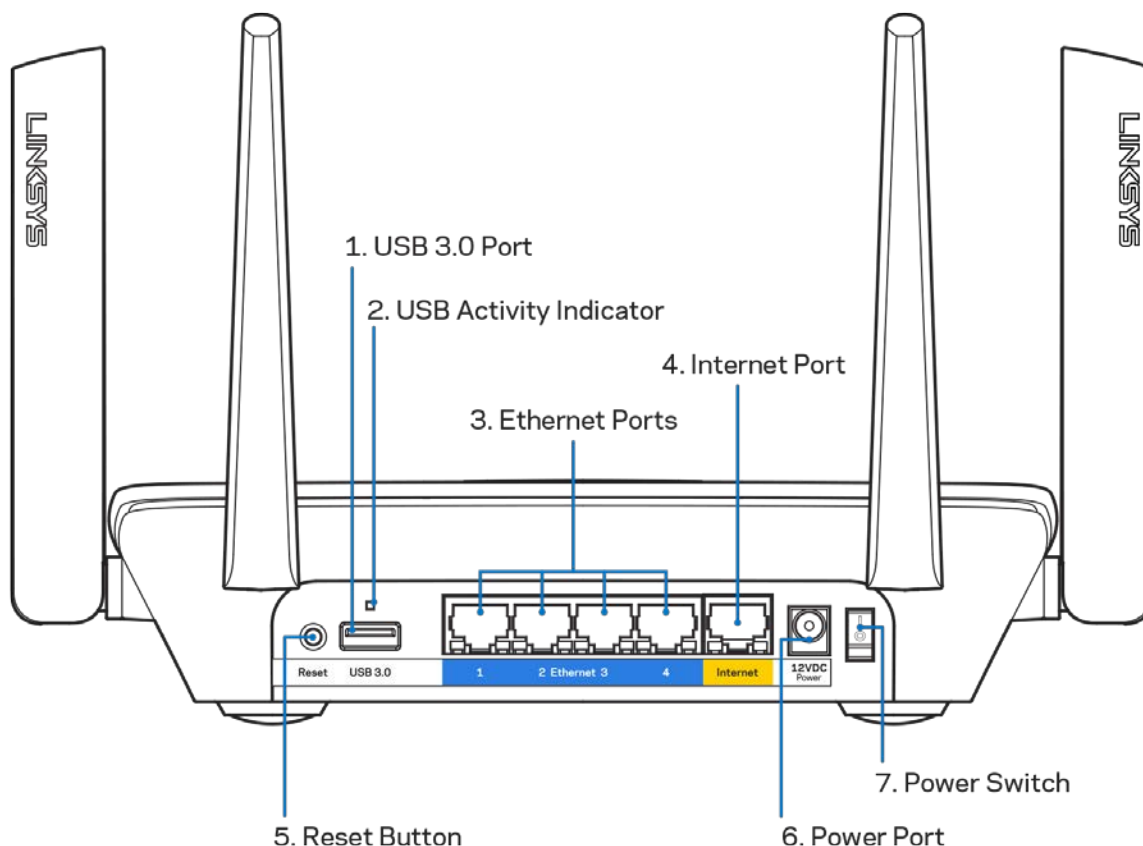

**USB 3.0 prievadas (1)** – prijunkite ir dalykitės USB įrenginiais tinkle arba internete.

**USB aktyvumo indikatorius (2)** – šviečia parodydamas duomenų persiuntimą į / iš išorinių įrenginių.

**Eterneto prievadai (3)** – prijunkite eterneto kabelius prie šių mėlynų gigabito (10 / 100 / 1000) prievadų ir tinklo laidinių įrenginių.

*Pastaba – siekdami geriausių rezultatų, prie eterneto prievadųjunkite CAT5e ar aukštesnės klasės laidus.*

**Interneto prievadas (4)** – prijunkite eterneto kabelį prie šio geltono gigabitų (10/100/1000) prievado ir prie plačiajuosčio interneto kabelio / DSL arba pluoštinio modemo.

*Pastaba – siekdami geriausių rezultatų, prie eterneto prievadųjunkite CAT5e ar aukštesnės klasės laidus.*

**Mygtukas „Reset“ (atkurti) (5)** – paspauskite ir palaikykite, kol išsijungs apšviestas „Linksys“ logotipas, kad atkurtumėte gamyklines maršruto parinktuvo nuostatas. Be to, gamyklines nuostatas galima atkurti naudojant „Linksys Smart Wi-Fi“ internete arba per programėlę mobiliems.

**Maitinimo prievadas (6)** – prijunkite pridedamą kintamosios srovės adapterį.

**Maitinimo jungiklis (7)** – paspauskite | (šviečia), kad įjungtumėte maršruto parinktuvą.

## Vaizdas iš šono

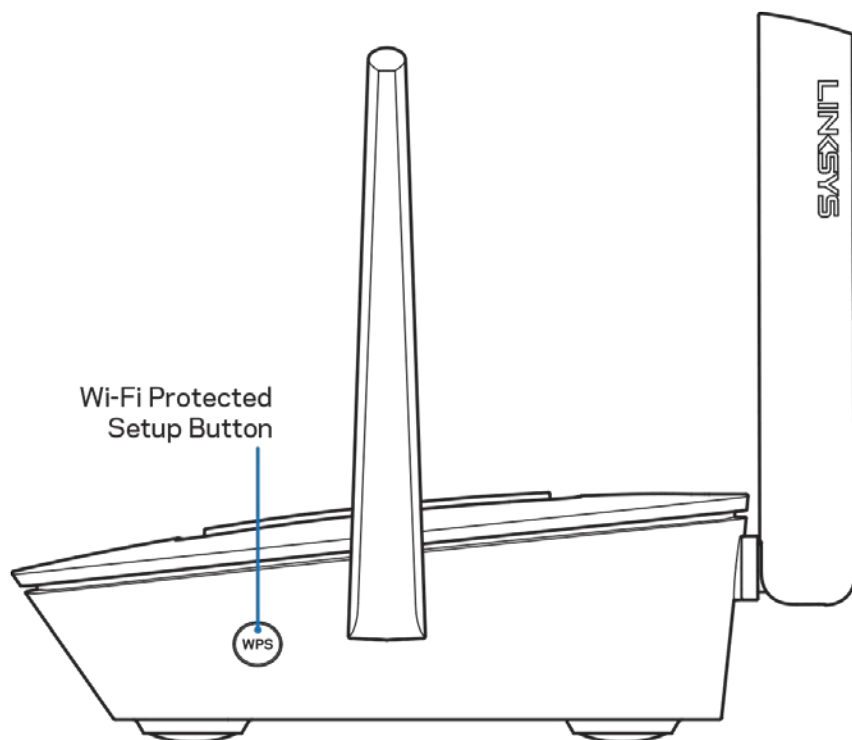

**Mygtukas „Wi-Fi Protected Setup™“** - paspauskite norėdami jungtis prie tinklo įrenginių, kuriuose įjungta WPS parinktis.

# Nustatymas: pagrindinė informacija

## Kur pateikiama daugiau pagalbos

Pagalbos galite rasti ne tik šiame naudotojo vadove, bet ir šiose vietose:

- [Linksys.com/support/EA8300](http://Linksys.com/support/EA8300) (dokumentacija, atsisiuntimai, DUK, techninė pagalba, tiesioginiai pokalbiai, forumai)
- „Linksys Smart Wi-Fi“ pagalba (prisijunkite prie „Linksys Smart Wi-Fi“, paskui spustelėkite „Pagalba“ ekrano viršuje)

The screenshot shows the Linksys Smart Wi-Fi web interface. The top navigation bar includes 'App Center', 'Help' (highlighted with a red circle), 'Linksys15895', and 'Christopher K.'. The main interface is divided into a left sidebar with 'Smart Wi-Fi Tools' and 'Router Settings' sections, and a main content area with various status and configuration widgets. Below the main interface, a 'Help' window is open, displaying the 'Using Linksys Smart Wi-Fi' section and a 'Help Categories' list.

**Using Linksys Smart Wi-Fi**

Linksys Smart Wi-Fi allows you to access all of your router's features and settings. Simply click on a feature or widget you want to open.

You can use Linksys Smart Wi-Fi to:

- See what's currently connected to your network, and connect more computers and devices.
- Create a Linksys Smart Wi-Fi account to access router settings from anywhere using any browser, even when you're away from home. You can personalize your router and change settings for wireless access, Internet, gaming, local network, and more. You can even access router settings for multiple routers, which is helpful if you set up and manage more than one router. (The account is available only on EA-Series routers.)
- Allow guests in your home to use the Internet without giving them access to your network. While on the guest network, users can surf the net, but won't be able to access your printers, other computers, or devices on your network.

**Help Categories**

- Linksys Smart Wi-Fi
- Device List
- Guest Access
- Parental Controls
- Media Prioritization
- Speed Test
- External Storage
- Connectivity

Ok

**Pastaba.** Šiame gaminyje naudojamos trečiųjų šalių įrangos licencijas ir pranešimus galima peržiūrėti <http://support.linksys.com/en-us/license>. Susisiekite su <http://support.linksys.com/en-us/gplcodecenter>, jei turite klausimų arba GPL šaltinio kodo užklausų.

## Kaip prijungti maršruto parinktuvą

1. Sąrankai atlikti jums reikės kompiuterio, kad galėtumėte apsilankyti <http://LinksysSmartWiFi.com> žiniatinklio naršyklėje.
2. Nustatykite savo įrangą.

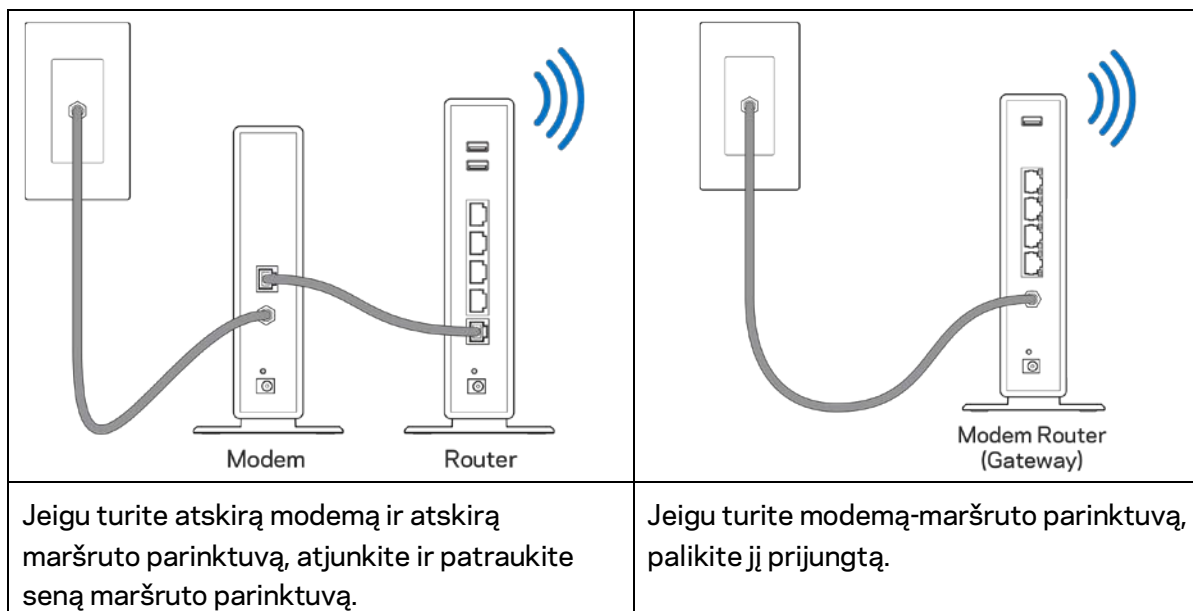

3. Nustatykite antenas į viršų ir prijunkite maršruto parinktuvą prie maitinimo šaltinio. Įsitikinkite, kad maitinimo jungiklis yra | (įjungimo) padėtyje.
4. Prijunkite savo maršruto parinktuvą prie modemo arba modemo-maršruto parinktuvo. Prijunkite vieną pridėdama interneto kabelio galą prie geltonos interneto jungties naujame maršruto parinktuve. Jeigu turite modemą, kitą galą prijunkite prie modemo eternetu (LAN) jungties. Jeigu turite modemą-maršruto parinktuvą, prijunkite jį prie laisvos jungties.
5. Palaukite, kol šviečianti „Linksys“ lemputė maršruto parinktuvo viršuje nustos mirksėti ir pradės šviesti baltai.
6. Prijunkite prie „W-Fi“, kurio pavadinimas nurodytas kartu su maršruto parinktuvu gautame Greito pasirengimo vadove. (Šią išsamią informaciją galite keisti vėliau.) Jei reikia pagalbos prisijungiant prie tinklo, žr. įrenginio dokumentaciją adresu [linksys.com/support/EA8300](http://linksys.com/support/EA8300).

**Pastaba:** *jūs neturėsite prieigos prie interneto, kol nebus baigta maršruto parinktuvo sąranka.*

7. Žiniatinklio naršyklėje atverkite <http://LinksysSmartWiFi.com>. Norėdami baigti maršruto parinktuvo sąranką, vykdykite ekrane pateiktas instrukcijas. Taip pat norėdami pradėti sąranką į naršyklę galite įvesti 192.168.1.1.

Sąrankos pabaigoje vykdykite ekrane pateiktas instrukcijas ir nustatykite „Linksys Smart Wi-Fi“ paskyrą. Naudokite „Linksys Smart Wi-Fi“ maršruto parinktuvui iš bet kurio interneto ryšį turinčio kompiuterio sukongigūruoti.

Maršruto parinktovo nustatymų valdymas:

- pakeiskite maršruto parinktovo pavadinimą ir slaptažodį;
- nustatykite svečio prieigą;
- sukongigūruokite tėvų kontrolės valdiklius;
- prijunkite įrenginius prie „Wi-Fi“;
- išbandykite interneto ryšio greitį.

**Pastaba:** jums atliekant „Linksys Smart Wi-Fi“ paskyros sąranką, gausite patvirtinimo el. laišką. Savo namų tinkle paspauskite el. laiške gautą nuorodą ir susiekite maršruto parinktuvą su „Linksys Smart Wi-Fi“ paskyra.

**Patarimas:** atsispausdinkite šį puslapį, tuomet įrašykite maršruto parinktovo ir paskyros nuostatas į toliau pateiktą lentelę kaip nuorodą. Pastabas laikykite saugioje vietoje.

2,4 GHz „Wi-Fi“ pavadinimas	
„Wi-Fi“ slaptažodis	
5 GHz <sub>1</sub> „Wi-Fi“ pavadinimas	
„Wi-Fi“ slaptažodis	
5 GHz <sub>2</sub> „Wi-Fi“ pavadinimas	
„Wi-Fi“ slaptažodis	
Maršruto parinktuvo slaptažodis	
2,4 GHz svečio „Wi-Fi“ pavadinimas	
5 GHz svečio „Wi-Fi“ pavadinimas	
Svečio „Wi-Fi“ slaptažodis (abu turi slaptažodį.)	
„Linksys Smart Wi-Fi“ vartotojo vardas	
„Linksys Smart Wi-Fi“ slaptažodis	



# Kaip naudoti „Linksys Smart Wi-Fi“

Maršruto parinktuvą galite konfigūruoti bet kurioje pasaulio vietoje, naudodami „Linksys Smart Wi-Fi“. Tačiau jį galite konfigūruoti ir tiesiogiai namų tinkle. „Linksys Smart Wi-Fi“ taip pat galima naudoti mobiliam įrenginiui. Norėdami gauti informacijos, žr. įrenginio programėlių prekyvietę.

## Kaip prijungti prie „Linksys Smart Wi-Fi“

Norint prijungti prie „Linksys Smart Wi-Fi“

1. Atverkite kompiuterio žiniatinklio naršyklę.
2. Apsilankykite adresu <http://LinksysSmartWiFi.com> ir prisijunkite prie savo paskyros.

Linksys Smart Wi-Fi Sign In

If you have not yet created a Linksys Smart Wi-Fi account, click the "Create Account" button in the upper right corner of the page.

Give guests Internet access

Use your Linksys Smart Wi-Fi account to access your home network from anywhere, at any time, even from your mobile device. Easily connect new devices, set parental controls, get access to Smart Wi-Fi mobile Apps, and more.

For more information [click here](#)

English (United States)

For local access, [click here](#).

Jei neprisimenate slaptažodžio, paspauskite „*Forgot your password?*“ (pamiršote slaptažodį?) ir vykdykite ekrane pateiktas instrukcijas, kad jį atkurtumėte.

## Tinklo žemėlapis

Leidžia peržiūrėti ir valdyti visus prie maršruto parinktuvo prijungtus tinklo prietaisus. Galite peržiūrėti pagrindiniame ir svečio tinkluose esančius prietaisus arba peržiūrėti informaciją apie kiekvieną prietaisą.



## Svečio prieiga

Leidžia nustatyti ir stebėti svečių tinklą, kad jie galėtų pasiekti „Wi-Fi“ negaudami prieigos prie asmeninės informacijos.

The screenshot shows a 'Guest Access' configuration window. At the top, there's a title bar with 'Guest Access' and a checkbox 'Show widget on the homepage' which is checked. Below the title bar, there's a subtitle: 'Guest access allows visitors to connect to your wireless guest network and access the Internet, without giving access to your other computers or personal data.' The main area has a section 'Allow guest access' with a toggle switch set to 'ON'. To the right of this section is a warning box with an exclamation mark icon and the text: 'Your guest should first connect to your guest network, open a web browser, and then enter the guest password.' Below this, there's a section 'Guest network names and password' with an 'Edit' link. It lists: '2.4 GHz SSID: parlor2.4', 'Network: Enabled', '5 GHz SSID: parlor5', 'Network: Enabled', and 'Guest network password: thefly'. At the bottom, there's a section 'Total guests allowed' with a dropdown menu set to '5 guests'. At the bottom right, there are 'OK' and 'Cancel' buttons.

## Tėvų kontrolė

Leidžia užblokuoti žiniatinklio svetaines ir nustatyti prieigos prie interneto laiką.

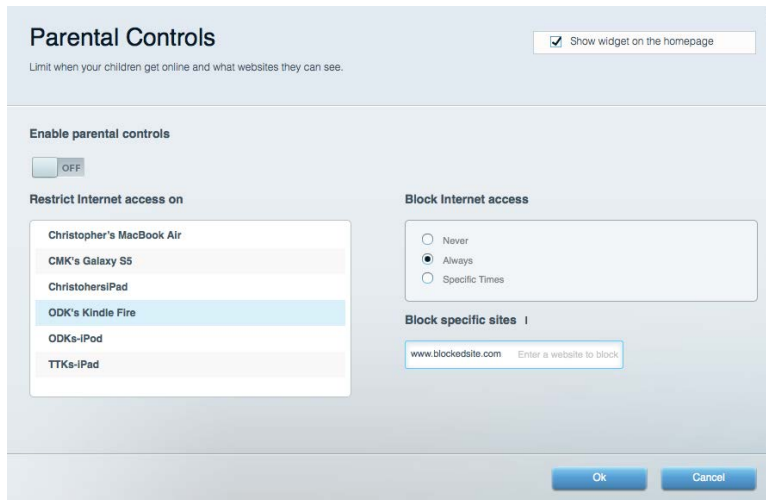

## Medijos prioritizacija

Leidžia nustatyti, kurie prietaisai ir programos jūsų tinklo sraute turi prioritetą.

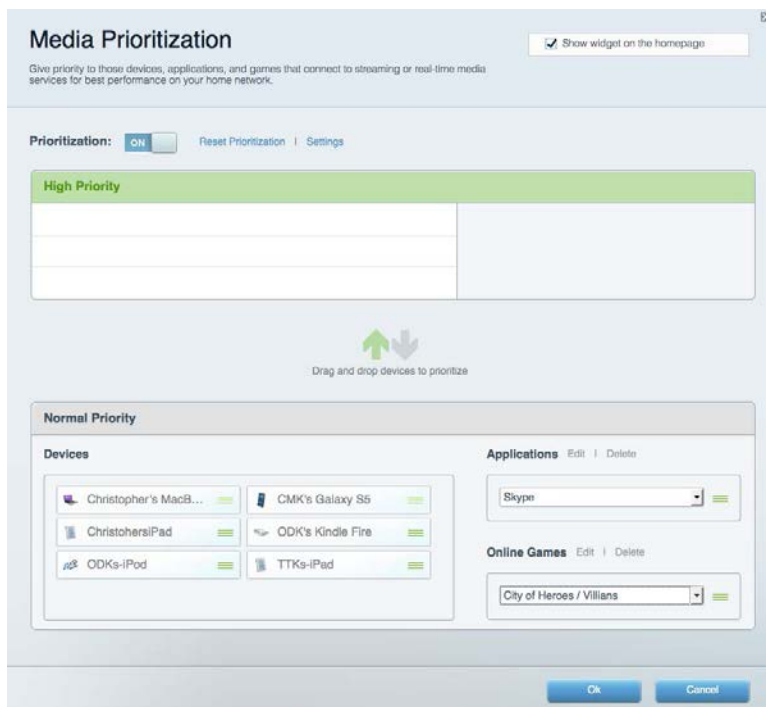

## Greičio bandymas

Leidžia išbandyti tinklo interneto ryšio greitį.



## Išorinė saugykla

Leidžia pasiekti prijungtą USB diską (nepriedamas) ir nustatyti failų bendrinimą, medijos serverį ir FTP prieigą.

The image shows the 'External Storage' configuration window. It has a 'Show widget on the homepage' checkbox checked. Below are three tabs: 'Status', 'Folder Access', 'FTP Server', and 'Media Server'. The 'Folder Access' tab is active, showing 'External Storage Drive' with volume name 'ROUND DRIVE' and a progress bar for space used (886 MB of 960 MB). To the right, 'Secure Folder Access is OFF' is shown with PC and Mac access paths. Below that, 'FTP Server is OFF' is shown with the server status 'Disabled'. At the bottom, 'Media Server (DLNA) is ON' is shown with the DLNA server name 'EA6050'. An 'Ok' button is at the bottom right.

Setting	Status	Value
Secure Folder Access	OFF	Any user can access content via shared folders.
FTP Server	OFF	Content is not accessible to any user via FTP.
Media Server (DLNA)	ON	Media content is accessible to DLNA clients.

## Jungiamumas

Leidžia peržiūrėti ir keisti pagrindinius ir išplėstinius tinklo nustatymus.

The screenshot shows the 'Connectivity' settings page of a router. It features a navigation bar with tabs for 'Basic', 'Internet Settings', 'Local Network', 'Advanced Routing', 'VLAN', and 'Administration'. The 'Internet Settings' tab is active. The page is divided into several sections: 'Network Name and Password' with fields for 2.4 GHz and 5 GHz network names and passwords; 'Router Password' with a masked password field; 'Router Firmware Update' with a checked 'Automatic' option and a 'Check for Updates' button; 'Time Zone' with a dropdown menu set to '(GMT-05:00) Eastern Time (USA & Canada)' and a checked 'Automatically adjust for Daylight Savings Time' option; and 'Activity Lights' with an 'ON' toggle and a descriptive text box. At the bottom, there are 'Ok', 'Cancel', and 'Apply' buttons.

## Trikčių nustatymas ir šalinimas

Leidžia nustatyti maršruto parinktuvo problemas ir patikrinti tinklo būseną.

The screenshot shows the 'Troubleshooting' settings page of a router. It features a navigation bar with tabs for 'Status', 'Diagnostics', and 'Logs'. The 'Diagnostics' tab is active. The page is divided into several sections: 'Ping IPv4' with input fields for IP or host name and number of pings, and a 'Start to Ping' button; 'Trace route' with an input field for IP or host name and a 'Start to Traceroute' button; 'Reboot' with a 'Reboot the router' link; 'Router configuration' with 'Backup' and 'Restore' buttons; 'Router Firmware' with a 'Restore previous firmware' button; 'Internet Address' showing IPv4 (10.0.0.253) and IPv6 (2601:0540::000:0019:0000:0000:0000:314e) addresses with 'Release and Renew' links; and 'Factory reset' with a 'Reset to factory default settings' link. An 'Ok' button is located at the bottom right.

## Belaidis ryšys

Leidžia peržiūrėti ir keisti maršruto parinktuvo belaidžio ryšio tinklą. Galite pakeisti tinklo pavadinimą, saugos režimą, slaptažodį, MAC filtravimą ir prijungti prietaisus naudojant „Wi-Fi Protected Setup“.

Wireless

View and change router settings

Wireless | MAC Filtering | Wi-Fi Protected Setup

Smart Connect:  5 GHz band steering (5 GHz<sub>1</sub> + 5 GHz<sub>2</sub>)  Off (Individual networks) What is Smart Connect band steering?

Network name: arachnid 2.4 GHz Network:  ON

Password: peterparker Broadcast SSID: Yes Channel: Auto

Security mode: WPA2/WPA Mixed Pt Network mode: Mixed Channel width: Auto

Network name: arachnid\_5GHz 5 GHz<sub>1</sub> + 5 GHz<sub>2</sub> Network:  ON

Password: peterparker Broadcast SSID: Yes Channel: Auto

Security mode: WPA2/WPA Mixed Pt Network mode: Auto Channel width: Auto

Ok Cancel Apply

## Sauga

Leidžia peržiūrėti ir keisti maršruto parinktuvo belaidžio ryšio saugą. Galite nustatyti ugniasienę, VPN nustatymus ir atlikite pasirinktinius programų ir žaidimų nustatymus.

Security

View and change router settings

Firewall | DMZ | Apps and Gaming

**Firewall**

IPv4 SPI firewall protection  Enabled

IPv6 SPI firewall protection  Enabled

**Internet filters**

Filter anonymous Internet requests

Filter multicast

Filter Internet NAT redirection

Filter ident (Port 113)

**VPN Passthrough**

IPSec Passthrough  Enabled

PPTP Passthrough  Enabled

L2TP Passthrough  Enabled

**IPv6 Port Services**

Description	Protocol	IPv6 Address	Allow	Enabled

Add IPv6 Firewall Setting

Ok Cancel Apply

# Trikčių nustatymas ir šalinimas

Daugiau pagalbos iš mūsų apdovanojimą laimėjusios klientų aptarnavimo tarnybos rasite adresu [linksys.com/support/EA8300](http://linksys.com/support/EA8300).

## Maršrutizatorius nustatytas nesėkmingai

Jei „Linksys Smart Wi-Fi“ neatlieka sąrankos, galite išmėginti šiuos veiksmus:

- Paspauskite ir laikykite nuspaudę ant maršrutizatoriaus esantį mygtuką Nustatyti iš naujo su sąvaržėle arba smeigtuku tol, kol išsijungs šviečiantis „Linksys“ logotipas ir pradės mirksėti „MU-MIMO“ indikatoriai (apie 10 sekundžių). Vėl prijunkite maršruto parinktuvą.

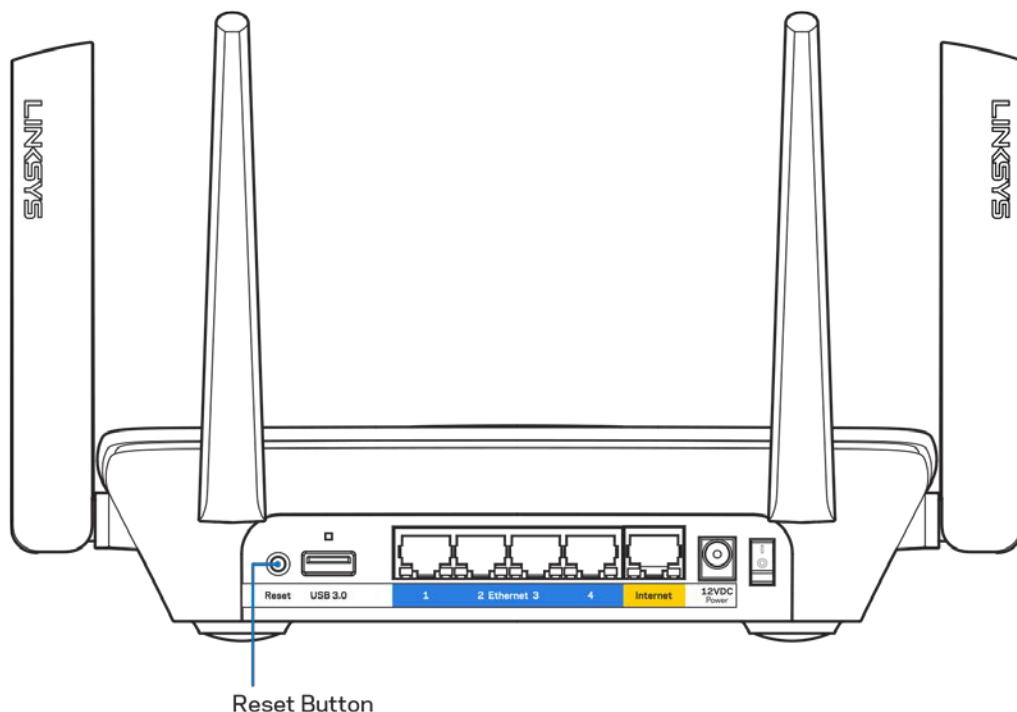

- Laikusiai išjunkite kompiuterio ugniasienę (žr. saugos programinės įrangos instrukcijas, kur pateikiama pagalba). Vėl prijunkite maršruto parinktuvą.
- Jei turite kitą kompiuterį, naudokite tą kompiuterį ir vėl prijunkite maršruto parinktuvą.

## Pranešimas *Your Internet cable is not plugged in* (apie neprijungtą interneto kabelį)

Jei rodomas pranešimas „Jūsų interneto kabelis neprijungtas“, mėginant nustatyti maršrutizatorių, atlikite šiuos trikčių šalinimo veiksmus.

- Įsitikinkite, kad eterneto arba interneto kabelis (arba toks pats kaip gautas su maršruto parinktuvu kabelis) yra tinkamai prijungtas prie geltono interneto prievado maršruto parinktuvo gale ir prie tinkamo prievado modeme. Šis modemo prievadas įprastai paženklintas kaip „Ethernet“ (eternetas).

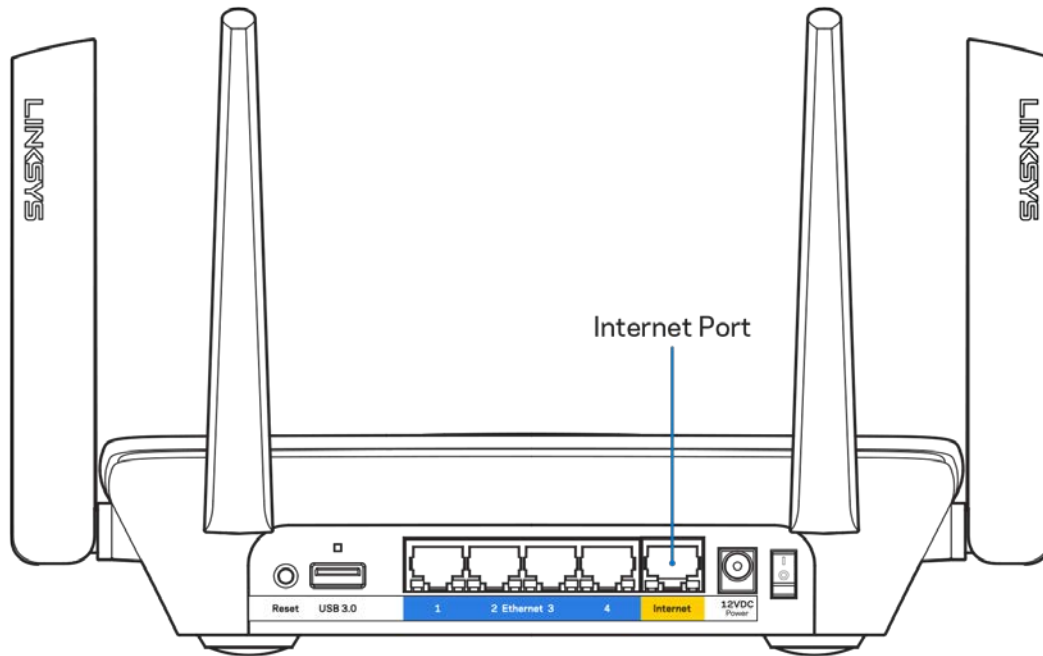

- Įsitikinkite, kad modemas prijungtas prie maitinimo ir yra įjungtas. Jei jis turi maitinimo jungiklį, įsitikinkite, kad jis nustatytas į ON (įjungta) arba I padėtį (o ne O padėtį).

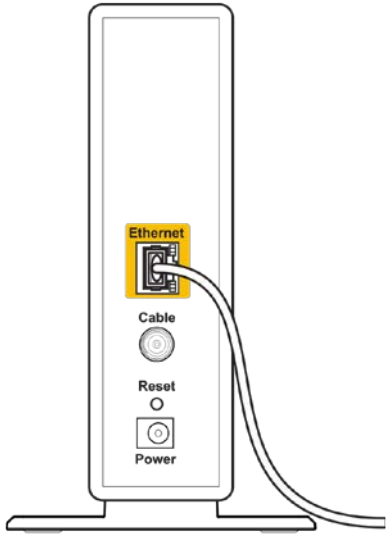
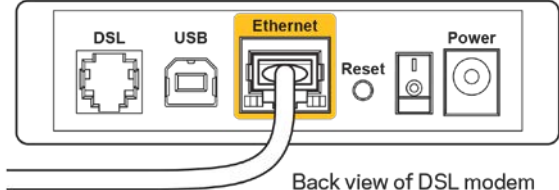

 <p>Back view of cable modem</p>	 <p>Back view of DSL modem</p>
<p>Jei interneto paslauga yra kabelinė, įsitikinkite, kad kabelio modemo CABLE (kabelio) prievadas yra prijungtas prie ISP tiekiamo bendraašio kabelio.</p>	<p>Jei interneto paslauga yra teikiama per DSL, įsitikinkite, kad DSL telefono linija yra prijungta prie modemo DSL prievado.</p>

- Jei kompiuteris anksčiau buvo prijungtas prie modemo USB laidu, atjunkite USB laidą.
- Vėl prijunkite maršruto parinktuvą.

## Pranešimas *Cannot access your router* (nepavyko pasiekti maršrutizatoriaus)

Norėdami pasiekti maršruto parinktuvą, turite prisijungti prie tinklo. Jei turite belaidę interneto prieigą, gali būti, kad atsitiktinai prisijungėte prie kito belaidžio tinklo.

Norėdami pašalinti problemą „Windows“ kompiuteriuose, atlikite šiuos veiksmus\*:

1. Spustelėkite belaidžio ryšio piktogramą sistemos dėkle. Bus parodytas galimų tinklų sąrašas.

- Spustelėkite tinklo pavadinimą. Spustelėkite „Prisijungti“. Pavyzdyje toliau kompiuteris buvo prijungtas prie kito belaidžio ryšio tinklo, pavadinto „wraith\_5GHz“. „Linksys EA8300“ maršruto parinktuvo belaidžio ryšio tinklo pavadinimas (šiam pavyzdyje – „Damaged\_Beez2.4“) yra rodomas parinktas.



- Paraginus įvesti tinklo saugos kodą, įveskite slaptažodį (saugos kodą) į tinklo saugos kodo laukelį. Spustelėkite **OK** (gerai).
- Kompiuteris jungsis prie tinklo ir jūs galėsite pasiekti maršrutizatorių.

*\*Priklausomai nuo „Windows“ versijos, atliekant šiuos veiksmus žodžiai ar piktogramos gali skirtis.*

Norėdami pašalinti problemą „Mac“ kompiuteriuose, atlikite šiuos veiksmus:

- Meniu juostoje, esančioje ekrano viršuje, spustelėkite „Wi-Fi“ piktogramą. Bus parodytas belaidžių tinklų sąrašas.
- Pavyzdyje toliau kompiuteris buvo prijungtas prie kito belaidžio ryšio tinklo, pavadinto „wraith\_5GHz“. „Linksys EA8300“ maršruto parinktuvo belaidžio ryšio tinklo pavadinimas (šiam pavyzdyje – „Damaged\_Beez2.4“) yra rodomas parinktas.



3. Spustelėkite „Linksys EA8300“ maršruto parinktuvo belaidžio ryšio tinklo pavadinimą (pavyzdyje – „Damaged\_Beez2.4“).
4. Įrašykite belaidžio tinklo slaptažodį (saugos kodą) į laukelį „Password“ (slaptažodis). Spustelėkite OK (gerai).

## Po sąrankos

### Nėra interneto

Jei internetui kilo sunkumų užmezgant ryšį su jūsų maršruto parinktuvu, žiniatinklio naršyklėje problema gali būti parodyta kaip pranešimas „Cannot find [internet address]“ (nepavyko rasti [internetu adresą]). Jei žinote, kad interneto adresas yra teisingas ir, pamėginus įvesti keletą galiojančių interneto adresų, buvo gautas tas pats rezultatas, pranešimas gali rodyti, kad kilo jūsų ISP arba modemo ryšio su maršruto parinktuvu problema. Pamėginkite atlikti šiuos veiksmus

- Įsitikinkite, kad tinkamai prijungti tinklo ir maitinimo laidai.
- Įsitikinkite, kad maitinimo lizdui, prie kurio prijungtas maršruto parinktuvas, tiekama įtampa.
- Perkraukite maršruto parinktuvą.
- Susisiekite su ISP ir pasiteiraukite apie ryšio nutraukimą jūsų vietovėje.

Dažniausiai naudojamas maršruto parinktuvo gedimų lokalizavimo būdas – jį išjungti ir vėl įjungti. Tuomet maršruto parinktuvas gali įkelti pasirinktinius parametrus, o kiti įrenginiai (pvz., modemas) galės rasti maršruto parinktuvą ir su juo užmegzti ryšį. Šis procesas vadinamas perkrovimu.

Norėdami perkrauti maršruto parinktuvą naudojant maitinimo laidą, atlikite šiuos veiksmus:

1. Atjunkite maitinimo laidą nuo maršruto parinktuvo ir modemo.
2. Palaukite 10 sekundžių, tada maitinimo laidą vėl prijunkite prie modemo. Įsitikinkite, kad juo teka įtampa.
3. Palaukite, kol nustos blyksėjęs modemo prisijungimo indikatorius (apie dvi minutes). Vėl prijunkite maitinimo laidą prie maršrutizatoriaus.
4. Palaukite, kol užsidegs šviečiantis „Linksys“ logotipas. Prieš mėgindami jungtis prie interneto kompiuteryje, palaukite dvi minutes.

Norėdami perkrauti maršruto parinktuvą naudojant „Linksys Smart Wi-Fi“, atlikite šiuos veiksmus:

1. Prisijunkite prie „Linksys Smart Wi-Fi“ (Žr. „Kaip prijungti prie „Linksys Smart Wi-Fi“ [11](#) psl.)
2. Ties nuostata *Router Settings* (maršruto parinktuvo nuostatos) paspauskite *Troubleshooting* (gedimų lokalizavimas).
3. Spustelėkite skirtuką *Diagnostics* (diagnostika).
4. Ties dalimi „Reboot“ (perkrauti) spustelėkite „Reboot“ (perkrauti).



5. Spustelėkite **Yes** (Taip). Maršruto parinktuvas bus perkrautas. Kol maršruto parinktuvas perkraunamas, visi prijungti įrenginiai praras interneto ryšį. Kai maršruto parinktuvas vėl bus pasiruošęs, jie automatiškai prisijungs iš naujo.

## „Linksys Smart Wi-Fi“ neatsidaro žiniatinklio naršyklėje

Naujausios „Google Chrome™“, „Firefox®“, „Safari®“ versijos (skirtos „Mac®“ ir „iPad®“), „Microsoft Edge“, „Internet Explorer®“ 8 versija ir naujesnės veikia su „Linksys Smart Wi-Fi“.

# Techniniai duomenys

## „Linksys EA8300“

Modelio pavadinimas	„Max-Stream AC2200 MU-MIMO“ trijų juostų maršruto parinktuvas
Modelio numeris	EA8300
Jungiklio prievado greitis	10 / 100 / 1 000 Mb/sek. (greitasis eternetas)
Radijo dažnis	2,4 ir 5 GHz (x2)
Antenų skaičius	4 išorinės reguliuojamos antenos (neatjungiamos)
Prievadai	USB 3.0, eterneto (1-4), interneto, maitinimo
Mygtukai	„Wi-Fi Protected Setup“, maitinimo, atkūrimo
Lemputės	<b>Viršutinis skydelis:</b> Apšviestas „Linksys“ logotipas, „Wi-Fi Protected Setup“, interneto ryšys, tinklo kabelio jungtis prie interneto prievado <b>Galinis skydelis:</b> USB, eternetas (1-4), internetas
UPnP	Palaikoma
Saugos funkcijos	WEP, WPA2, RADIUS
Saugos kodo bitai	Iki 128 bitų kodavimas
Failų saugojimo sistemos palaikymas	FAT, NTFS ir HFS+
Palaikomos naršyklės	Naujausios „Google Chrome™“, „Firefox®“, „Safari®“ versijos (skirtos „Mac®“ ir „iPad®“), „Microsoft Edge“ bei „Internet Explorer®“ 8 versija ir naujesnės

## Aplinkos duomenys

Matmenys	213,7mm x 161,8mm x 54,8mm (be antenų)
Gaminio svoris	608 g
maitinimas	12 V, 2A
Sertifikavimas	FCC, IC, CE, „Wi-Fi“ (a/b/g/n/ac)
Darbinė temperatūra	32-104 °F (0-40 °C)
Laikymo temperatūra	-4-140 °F (-20-60 °C)
Veikimo aplinkos drėgnis	10-80 % santykinis drėgnis, be kondensato
Laikymo aplinkos drėgnis	5-90%, be kondensato

Techniniai duomenys gali būti keičiami iš anksto nepranešus.

Pastabos:

reguliavimo, garantijos ir saugos informacijos ieškokite kartu su maršruto parinktuvu gautame kompaktiniame diske arba apsilankykite adresu [Linksys.com/support/EA8300](http://Linksys.com/support/EA8300).

Didžiausias našumas siejamas su IEEE standarto 802.11 techniniais duomenimis. Faktinis veikimas gali skirtis, įskaitant mažesnę belaidžio tinklo pajėgumą, duomenų perdavimo greitį, diapazoną ir aprėptį. Veikimo rezultatus lemia daugybė veiksnių, sąlygų ir kintamųjų, įskaitant atstumą nuo prieigos taško, tinklo srauto apimtį, statybines medžiagas ir konstrukciją, naudojamą operacinę sistemą, naudojamų belaidžių gaminių derinį, trikdžius ir kitas neigiamas sąlygas.

„BELKIN“, „LINKSYS“ ir daugelis gaminių pavadinimų ir logotipų yra „Belkin“ bendrovių grupės prekių ženklai. Minimi trečiųjų šalių prekių ženklai yra atitinkamų savininkų nuosavybė. Šiame gaminyje naudojamos trečiųjų šalių įrangos licencijas ir pranešimus galima peržiūrėti čia:

<http://support.linksys.com/en-us/license>. Susisiekite su <http://support.linksys.com/en-us/gplcodecenter>, jei turite klausimų arba GPL šaltinio kodo užklausų.

© 2017 m. „Belkin International, Inc.“ ir (arba) jos pavaldžiosios įmonės. Visos teisės saugomos.

**LINKSYS®**

Lietotāja rokasgrāmata

**MAX-STREAM™**

**AC2200 MU-MIMO**

**TRĪSJOSLU MARŠRUTĒTĀJS**

Modelis EA8300

# Saturs

<b>Pārskats par izstrādājumu.....</b>	<b>3</b>
Skats no augšas.....	3
Sistēmas statusa indikators .....	4
Skats no aizmugures.....	5
Skats no sāna.....	6
<b>Iestatīšana: Pamatinformācija .....</b>	<b>7</b>
Kur atrast papildu palīdzību.....	7
Kā instalēt jūsu maršrutētāju.....	8
<b>Kā lietot "Linksys Smart Wi-Fi" .....</b>	<b>11</b>
Kā pieslēgties "Linksys Smart Wi-Fi".....	11
Tīkla ierīču karte.....	12
Viesiem paredzētā piekļuve.....	12
"Vecāku" vadības rīki.....	13
Vides prioritizācija.....	13
Darbības ātruma pārbaude .....	14
Datu ārējās uzglabāšanas iespēja .....	14
Pieslēgums.....	15
Problēmrisinājumi.....	15
Bezvadu tīkls.....	16
Drošība .....	16
<b>Problēmrisinājumi .....</b>	<b>17</b>
Jūsu maršrutētāju iestatīt neizdevās.....	17
<i>Interneta kabelis nav pieslēgts</i> ziņojums.....	18
<i>Nav piekļuves maršrutētājam</i> ziņojums.....	19
Pēc iestatīšanas.....	21
Šķiet, ka internets nav pieejams .....	21
Jūsu tīmekļa pārlūkā neatveras sistēma Linksys Smart Wi-Fi.....	22
<b>Specifikācijas .....</b>	<b>23</b>
Linksys EA8300 .....	23
Vide.....	23



# Pārskats par izstrādājumu

## Skats no augšas

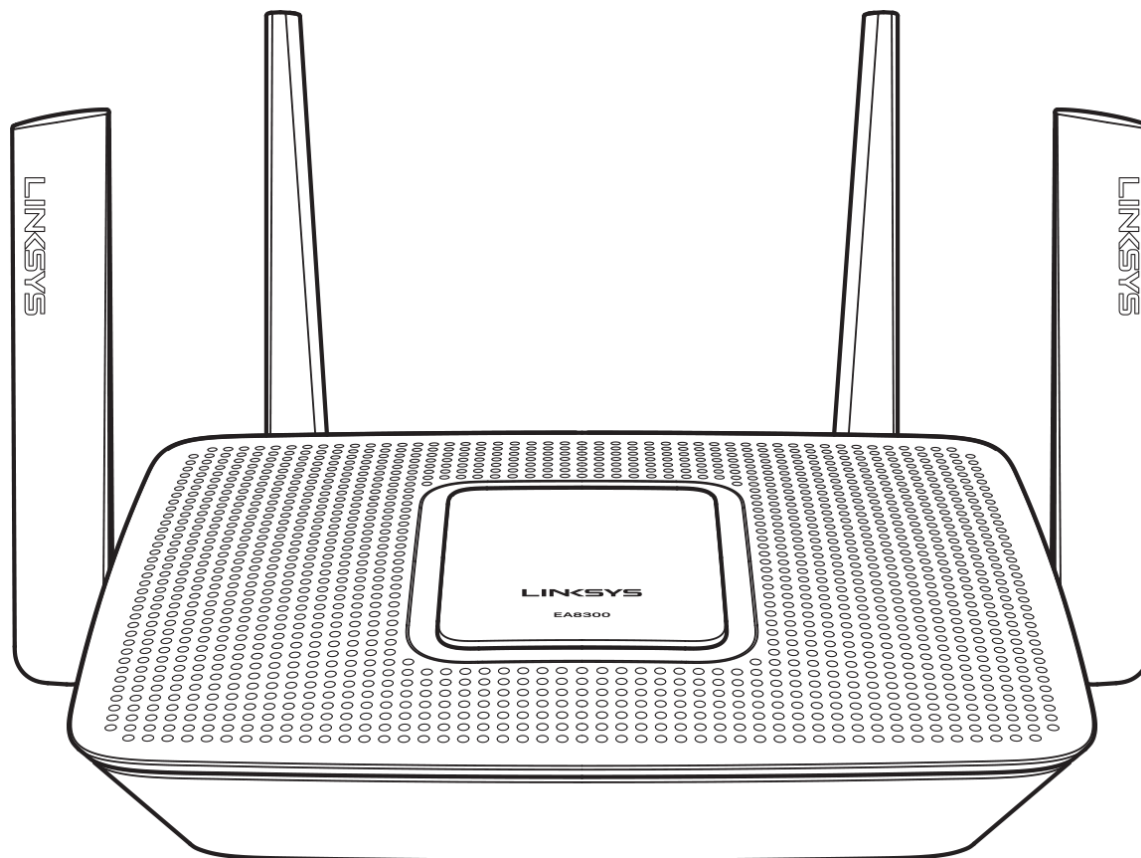

## Sistēmas statusa indikators

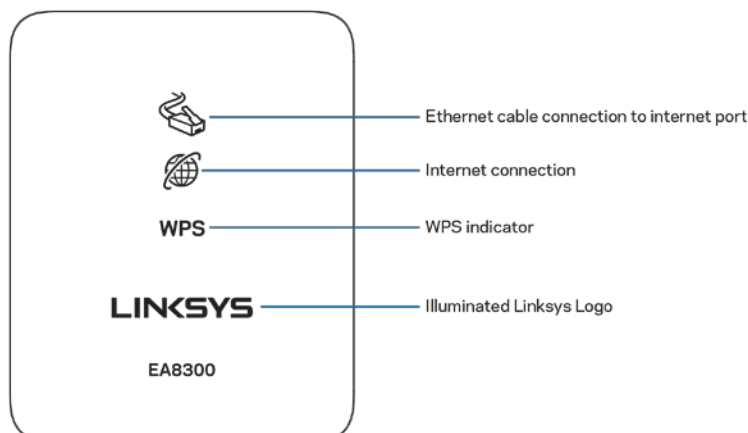

**Ethernet kabeļsavienojums ar Interneta pieslēgvietu**—kad deg (oranžā krāsā), norāda, ka kļūda ir ar Interneta (WAN) pieslēgvietu savienotajā tīkla kabeļsavienojumā.

**Interneta savienojums**—kad deg (oranžā krāsā), norāda, ka maršrutētājs nevar izveidot savienojumu ar Internetu.

**WPS (Wi-Fi Protected Setup™) indikators**—WPS gaismai ir četri stāvokļi, kas norādīti tālāk.

<b>Izslēgts</b>	Wi-Fi Protected Setup aktivitātes nav.
<b>Mirgo baltā gaismas diode</b>	Wi-Fi Protected Setup darbojas.
<b>Vienmērīgi deg baltās krāsas gaismas diode</b>	Wi-Fi Protected Setup veiksmīgi darbojas, paliek iedegta uz piecām sekundēm.
<b>Mirgo oranža gaismas diode</b>	Wi-Fi Protected Setup kļūda, mirgo vienu minūti, pēc tam izdziest.

**Izgaismots Linksys logotips**—kamēr maršrutētājs tiek palaists, logotips mirgo. Ja logotips vienmērīgi deg blatā krāsā, maršrutētājs ir ieslēgts un pareizi darbojas.

## Skats no aizmugures

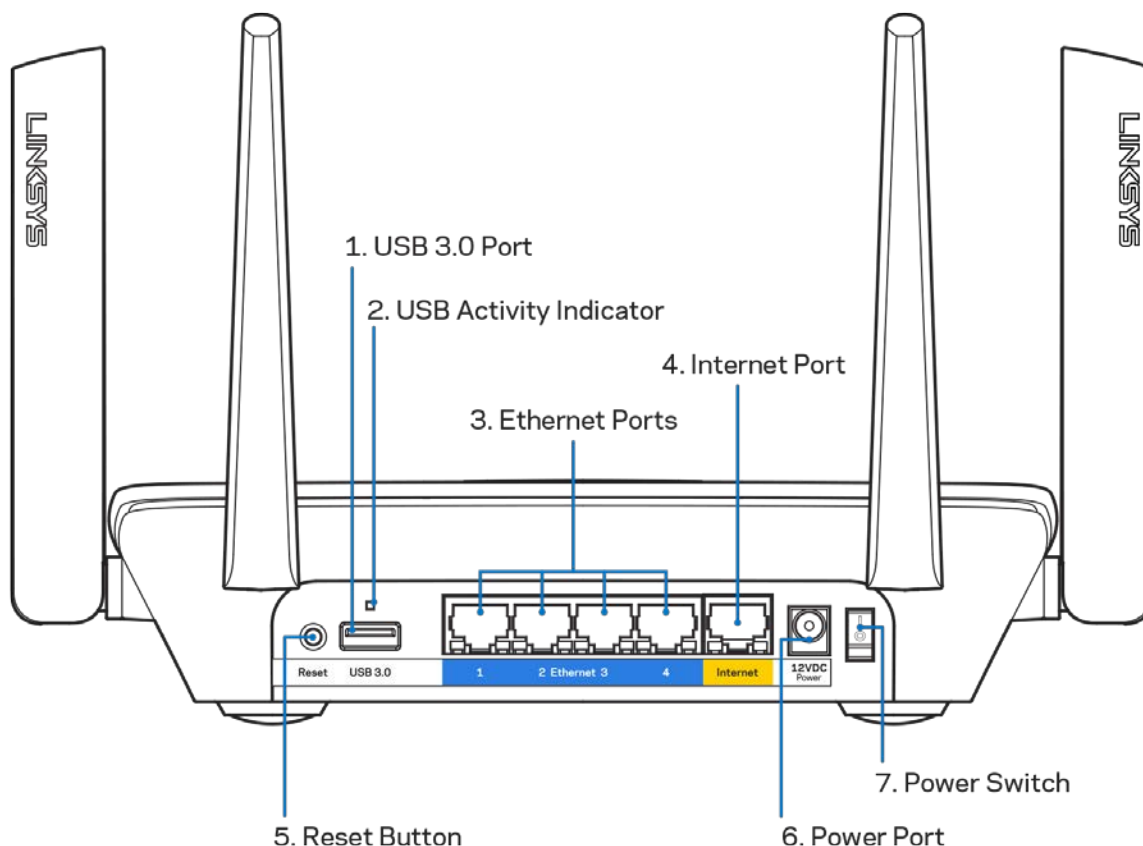

**USB 3.0 pieslēgvietas (1)**—Savienojiet un kopīgojiet Jūsu tīkla vai internetā esošos USB dziņus.

**USB aktivitātes indikators (2)**—gaismas norāda, ka uz/no ārējām ierīcēm tiek pārsūtīti dati.

**Ethernet pieslēgvietas (3)**—Ethernet kabelus savienojiet ar šīm zilajām gigabitu (10/100/1000) pieslēgvietā un Jūsu tīkla vadu ierīcēm.

*Piezīme - lai darbība būtu labāka, savienojumam ar Ethernet pieslēgvietām izmantojiet CAT5e vai augstākas kategorijas kabelus.*

**Interneta pieslēgvietā (4)**— Ethernet kabeli savienojiet ar šo dzelteni gigabitu (10/100/1000) pieslēgvietu un ar platjoslas Interneta kabeli/DSL vai šķiedru modēmu.

*Piezīme—Lai darbība būtu labāka, savienojumam ar interneta tīkla pieslēgvietu izmantojiet CAT5e vai augstākas kategorijas kabeli.*

**Atiestatīšanas poga (5)**—Nospiediet un turiet līdz izgaismotais Linksys logotips izdziest, lai maršrutētājam atiestatītu rūpnīcas iestatījumus. Jūs varat arī atiestatīt rūpnīcā ierīktos iestatījumus, izmantojot Linksys Smart Wi-Fi tīmeklī vai mobilo lietojumprogrammu.

**Barošanas pieslēgšanas ports (6)**—Pievienojiet komplektā iekļauto maiņstrāvas adapteri.

**Barošanas slēdzis (7)**—Nospiediet | (ieslēgts), lai ieslēgtu maršrutētāju.

## Skats no sāna

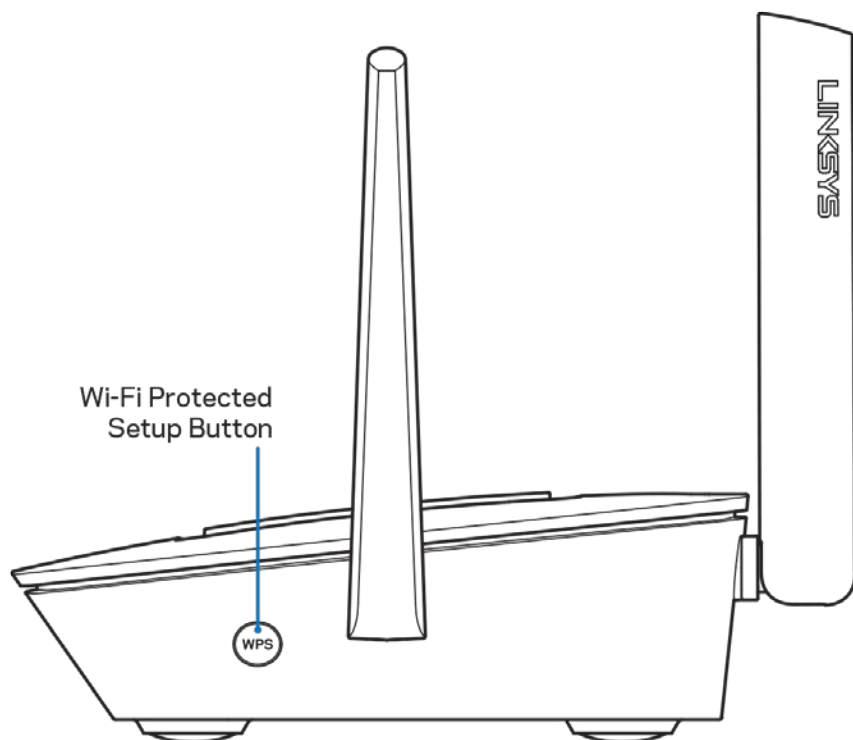

**Wi-Fi Protected Setup™ poga**—Nospiediet, lai veidotu savienojumu ar WPS iespējotām tīkla ierīcēm.

# Iestatīšana: Pamatinformācija

## Kur atrast papildu palīdzību

Papildus šai Lietotāja rokasgrāmatai jūs palīdzību varat atrast šādās vietās:

- [Linksys.com/support/EA8300](http://Linksys.com/support/EA8300) (dokumentācija, lejupielādes, BUJ, tehniskais atbalsts, tiešsaistes tērzēšana, forumi)
- *Linksys Smart Wi-Fi* palīdzība (pievienojieties *Linksys Smart Wi-Fi*; tad noklikšķiniet palīdzības pogu *Help* ekrāna augšdaļā)

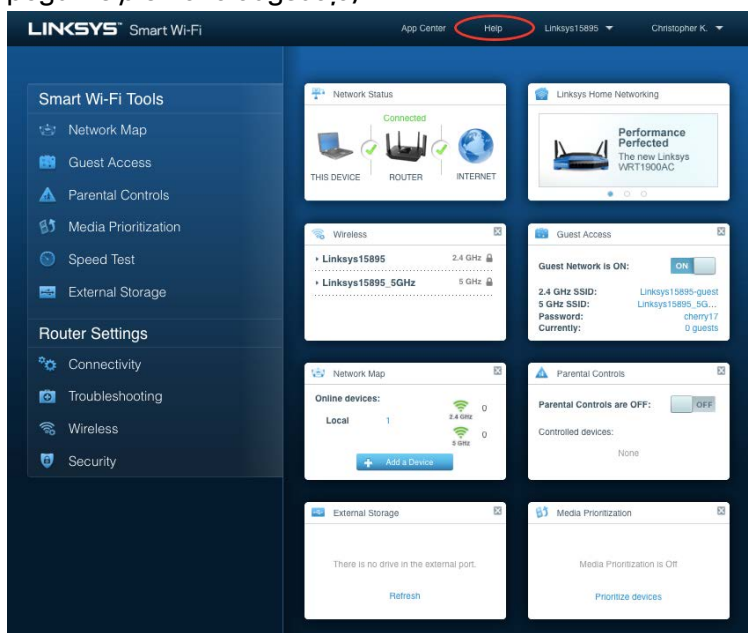

The screenshot shows the Linksys Smart Wi-Fi web interface. The top navigation bar includes 'App Center', 'Help' (highlighted with a red circle), 'Linksys15895', and 'Christopher K.'. The main content area is divided into several sections: 'Smart Wi-Fi Tools' (Network Map, Guest Access, Parental Controls, Media Prioritization, Speed Test, External Storage), 'Router Settings' (Connectivity, Troubleshooting, Wireless, Security), 'Network Status' (Connected), 'Linksys Home Networking' (Performance Perfected), 'Wireless' (Linksys15895 2.4 GHz, Linksys15895\_5GHz 5 GHz), 'Guest Access' (Guest Network is ON), 'Network Map' (Online devices: Local 1), 'Parental Controls' (Parental Controls are OFF), 'External Storage' (There is no drive in the external port), and 'Media Prioritization' (Media Prioritization is Off).

**Help**

**Using Linksys Smart Wi-Fi**

Linksys Smart Wi-Fi allows you to access all of your router's features and settings. Simply click on a feature or widget you want to open.

You can use Linksys Smart Wi-Fi to:

- See what's currently connected to your network, and connect more computers and devices.
- Create a Linksys Smart Wi-Fi account to access router settings from anywhere using any browser, even when you're away from home. You can personalize your router and change settings for wireless access, Internet, gaming, local network, and more. You can even access router settings for multiple routers, which is helpful if you set up and manage more than one router. (The account is available only on EA-Series routers.)
- Allow guests in your home to use the Internet without giving them access to your network. While on the guest network, users can surf the net, but won't be able to access your printers, other computers, or devices on your network.

**Help Categories**

- Linksys Smart Wi-Fi
- Device List
- Guest Access
- Parental Controls
- Media Prioritization
- Speed Test
- External Storage
- Connectivity

Ok

**Piezīme**—Šajā izstrādājumā izmantotās trešo personu programmatūras licences un paziņojumi ir aplūkoti šeit: <http://support.linksys.com/en-us/license>. Jautājumu vai GPL avota kodu pieprasījumu gadījumā, lūdzu, sazinieties ar <http://support.linksys.com/en-us/gplcodecenter>.

## Kā instalēt jūsu maršrutētāju

1. Lai pabeigtu iestatīšanu, Jūsu datora interneta pārlūkā jāapmeklē vietne <http://LinksysSmartWiFi.com>.
2. Identificējiet savu aprīkojumu.

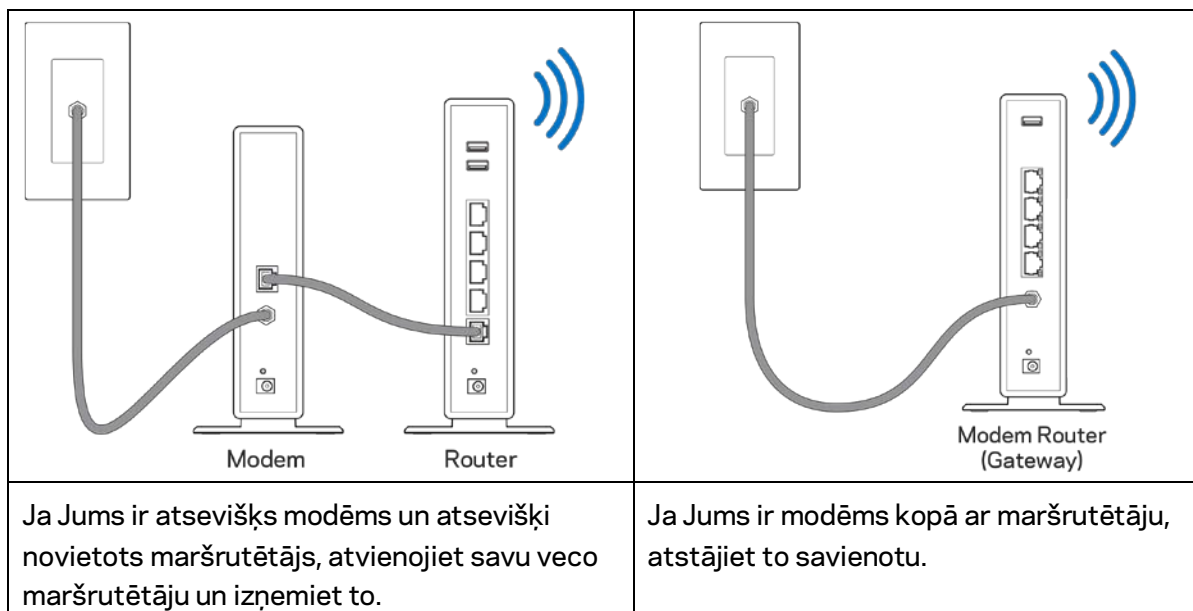

3. Pavērsiet antenas tieši uz augšu un pieslēdziet maršrutētāju barošanas avotam. Pārliedzinieties, ka ieslēgšanas slēdzis ir pozīcijā (ieslēgts).
4. Maršrutētāju savienojiet ar modēmu vai modēmu un maršrutētāju. Iekļautā interneta kabeļa vienu galu savienojiet ar jaunā maršrutētāja dzelteni interneta pieslēgvietu. Ja Jums ir modēms, otru galu savienojiet ar modēma Ethernet (LAN) pieslēgvietu. Ja Jums ir modēms un maršrutētājs, savienojiet ar jebkuru pieejamo pieslēgvietu.
5. Gaidiet līdz Jūsu maršrutētāja augšpusē esošā izgaismotā Linksys gaisma beidz mirgot un ir nemainīgi baltā krāsā.
6. Pieslēdzieties Wi-Fi tīkla nosaukumam, kas parādīts Ātrās darba sākšanas rokasgrāmatā, kas tika piegādāta ar maršrutētāju. (Jūs varat šos datus vēlāk mainīt.) Ja Jums vajadzīga palīdzība izveidot savienojumu ar tīklu, skatiet ierīces dokumentāciju vietnē [linksys.com/support/EA8300](http://linksys.com/support/EA8300).

**Piezīme**—*Piekļuve internetam ir liegta, iekams nav pabeigta maršrutētāja iestatīšana.*

7. Interneta pārlūkā ievadiet adresi <http://LinksysSmartWiFi.com>. Izpildiet ekrānā redzamos norādījumus, lai pabeigtu maršrutētāja uzstādīšanu. Jūs varat arī ievadīt adresi 192.168.1.1 pārlūkprogrammā, lai sāktu iestatīšanu.

Iestatīšanas beigās rīkojieties saskaņā ar ekrānā redzamajiem norādījumiem, lai izveidotu savu Linksys Smart Wi-Fi kontu. Izmantojiet Linksys Smart Wi-Fi, lai konfigurētu maršrutētāju no jebkura datora ar pieslēgumu Internet tīklam.

Maršrutētāja iestatījumu pārvaldība:

- maršrutētāja nosaukuma un paroles maiņa;
- piekļuves izveidošana viesim;
- "Vecāku" vadības rīku konfigurēšana;
- Ierīces savienojiet ar savu Wi-Fi
- jūsu Interneta tīkla savienojuma ātruma pārbaude.

**Piezīme**—*Linksys Smart Wi-Fi konta izveidošanas laikā jūs saņemsiet pārbaudes e-pasta ziņojumu. Savā mājas tīklā noklikšķiniet e-pasta ziņojumā saņemto saiti, lai savu maršrutētāju piesaistītu Linksys Smart Wi-Fi kontam.*

**Padoms** - *Izdrukājiet nākamo lappusi un tabulā atsaucei ierakstiet sava maršrutētāja un konta iestatījumus. Piezīmes glabājiet drošā vietā.*

2.4 GHz Wi-Fi Nosaukums	
Wi-Fi parole	
5 GHz <sub>1</sub> Wi-Fi nosaukums	
Wi-Fi parole	
5 GHz <sub>2</sub> Wi-Fi nosaukums	
Wi-Fi parole	
Maršrutētāja parole	
2.4 GHz viesu Wi-Fi nosaukums	
5GHz viesu Wi-Fi nosaukums	
Viesu Wi-Fi parole (abiem parole ir vienāda)	
Linksys Smart Wi-Fi lietotājsvārds	
Linksys Smart Wi-Fi parole	



# Kā lietot "Linksys Smart Wi-Fi"

Savu maršrutētāju variet pārvaldīt no jebkuras vietas pasaulē, izmantoto Linksys Smart Wi-Fi, bet varat to darīt arī tieši no mājas tīkla. Linksys Smart Wi-Fi tīkls var būt pieejams arī jūsu mobilajai ierīcei. Lai saņemtu informāciju, skatiet savas ierīces lietojumprogrammu veikalu.

## Kā pieslēgties "Linksys Smart Wi-Fi"

Kā pieslēgties "Linksys Smart Wi-Fi":

1. atveriet sava datora tīmekļa pārlūku;
2. Dodieties uz saiti <http://LinksysSmartWiFi.com> un piesakieties savā kontā.

Linksys Smart Wi-Fi Sign In

If you have not yet created a Linksys Smart Wi-Fi account, click the "Create Account" button in the upper right corner of the page.

Give guests Internet access

Use your Linksys Smart Wi-Fi account to access your home network from anywhere, at any time, even from your mobile device. Easily connect new devices, set parental controls, get access to Smart Wi-Fi mobile Apps, and more.

For more information [click here](#)

English (United States)

For local access, [click here](#).

Ja neatceraties savu paroli, noklikšķiniet uz *Forgot your password?* (Aizmirsāt savu paroli)? un izpildiet ekrānā redzamās norādes, lai to atgūtu.

## Tīkla ierīču karte

Sniedz jums iespēju pārlūkot un pārvaldīt visas jūsu maršrutētājam pieslēgtās tīkla ierīces. Jūs varat pārskatīt ierīces savā galvenajā tīklā un viesu tīklā vai pārlūkot informāciju par katru ierīci.



## Viesiem paredzētā piekļuve

Ļauj iestatīt un noverot tīklu viesiem, lai tie varētu piekļūt Wi-Fi, neatklājot personīgo informāciju.

The Guest Access configuration interface includes a 'Show widget on the homepage' checkbox (checked). Under 'Allow guest access', there is an 'ON' toggle switch. A warning box states: 'Your guest should first connect to your guest network, open a web browser, and then enter the guest password.' The 'Guest network names and password' section shows two networks: '2.4 GHz SSID: parlor2.4' and '5 GHz SSID: parlor5', both with 'Network: Enabled'. The 'Guest network password' is set to 'theyfy'. The 'Total guests allowed' is set to '5 guests' via a dropdown menu. 'Ok' and 'Cancel' buttons are at the bottom.

## "Vecāku" vadības rīki

Sniedz jums iespēju bloķēt tīmekļa vietnes un noteikt tīmekļa piekļuves laikus.

Parental Controls  Show widget on the homepage

Limit when your children get online and what websites they can see.

Enable parental controls  OFF

Restrict Internet access on

- Christopher's MacBook Air
- CMK's Galaxy S5
- ChristophersiPad
- ODK's Kindle Fire
- ODKs-iPod
- TTKs-iPad

Block Internet access

Never

Always

Specific Times

Block specific sites

www.blockedsite.com Enter a website to block

Ok Cancel

## Vides prioritizācija

Sniedz jums iespēju noteikt, kuras ierīces un lietojumprogrammas ir prioritāras jūsu tīklā.

Media Prioritization  Show widget on the homepage

Give priority to those devices, applications, and games that connect to streaming or real-time media services for best performance on your home network.

Prioritization:  ON [Reset Prioritization](#) | [Settings](#)

High Priority

Drag and drop devices to prioritize

Normal Priority

Devices

- Christopher's MacB...
- CMK's Galaxy S5
- ChristophersiPad
- ODK's Kindle Fire
- ODKs-iPod
- TTKs-iPad

Applications Edit | Delete

Skype

Online Games Edit | Delete

City of Heroes / Villians

Ok Cancel

## Darbības ātruma pārbaude

Sniedz jums iespēju pārbaudīt interneta pieslēguma ātrumu jūsu tīklā.



## Datu ārējās uzglabāšanas iespēja

Sniedz jums iespēju piekļūt pievienotajam USB dzinim (komplektācijā neietilpst) un izveidot datņu koplietošanu, multivides serveri un FTP piekļuvi.



## Pieslēgums

Ļauj skatīt un mainīt pamata un avancētus tīkla iestatījumus.

The screenshot shows the 'Connectivity' settings page of a router. It features a navigation bar with tabs for 'Basic', 'Internet Settings', 'Local Network', 'Advanced Routing', 'VLAN', and 'Administration'. The 'Basic' tab is selected. The page is divided into several sections: 'Network Name and Password' with fields for 2.4 GHz and 5 GHz network names and passwords; 'Router Password' with a masked password field; 'Router Firmware Update' with a checked 'Automatic' option and a 'Check for Updates' button; 'Time Zone' with a dropdown menu set to '(GMT-05:00) Eastern Time (USA & Canada)' and a checked 'Automatically adjust for Daylight Savings Time' option; and 'Activity Lights' with an 'ON' toggle and a text box explaining the power light status. At the bottom, there are 'Ok', 'Cancel', and 'Apply' buttons.

## Problēmrisinājumi

Sniedz jums iespēju diagnosticēt problēmas saistībā ar jūsu maršrutētāju un pārbaudīt tīkla statusu.

The screenshot shows the 'Troubleshooting' settings page of a router. It features a navigation bar with tabs for 'Status', 'Diagnostics', and 'Logs'. The 'Diagnostics' tab is selected. The page is divided into several sections: 'Ping IPv4' with input fields for IP or host name and number of pings, and a 'Start to Ping' button; 'Trace route' with an input field for IP or host name and a 'Start to Traceroute' button; 'Reboot' with a 'Reboot the router' link; 'Router configuration' with 'Backup' and 'Restore' buttons; 'Router Firmware' with a 'Restore previous firmware' button; 'Internet Address' showing IPv4 (10.0.0.253) and IPv6 (2601:0540::000:0019:0000:0000:0000:314e) addresses with 'Release and Renew' links; and 'Factory reset' with a 'Reset to factory default settings' link. At the bottom, there is an 'Ok' button.

## Bezvadu tīkls

Ļauj skatīt un mainīt maršrutētāja bezvadu tīklu. Ar Wi-Fi Protected Setup varat mainīt tīklu nosaukumus, drošības režīmu, paroli, MAC filtru un pievienotās ierīces.

Wireless

View and change router settings

Wireless MAC Filtering Wi-Fi Protected Setup

Smart Connect:  5 GHz band steering  Off

Network name: arachnid 2.4 GHz Network: ON

Password: peterparker Broadcast SSID: Yes Channel: Auto

Security mode: WPA2/WPA Mixed Pt Network mode: Mixed Channel width: Auto

Network name: arachnid\_5GHz 5 GHz<sub>1</sub> + 5 GHz<sub>2</sub> Network: ON

Password: peterparker Broadcast SSID: Yes Channel: Auto

Security mode: WPA2/WPA Mixed Pt Network mode: Auto Channel width: Auto

Ok Cancel Apply

## Drošība

Ļauj skatīt un mainīt maršrutētāja bezvadu drošību. Jūs varat izveidot uguns mūri, VPN iestatījumus, kā arī izveidot individualizētus iestatījumus lietojumprogrammām un spēlēm.

Security

View and change router settings

Firewall DMZ Apps and Gaming

Firewall

IPv4 SPI firewall protection  Enabled

IPv6 SPI firewall protection  Enabled

Internet filters

Filter anonymous Internet requests

Filter multicast

Filter Internet NAT redirection

Filter ident (Port 113)

VPN Passthrough

IPSec Passthrough  Enabled

PPTP Passthrough  Enabled

L2TP Passthrough  Enabled

IPv6 Port Services

Description	Protocol	IPv6 Address	Allow	Enabled
-------------	----------	--------------	-------	---------

Add IPv6 Firewall Setting

Ok Cancel Apply

# Problēmrisinājumi

Palīdzību varat iegūt mūsu apbalvotajā klientu atbalsta programmā [linksys.com/support/EA8300](https://linksys.com/support/EA8300).

## Jūsu maršrutētāju iestatīt neizdevās

Ja Linksys Smart Wi - Fi neveic iestatīšanu, varat rīkoties šādi:

- Ar saspraudi nospiediet un turiet nospiestu maršrutētāja Reset (atiestatīšanas) pogu, līdz izgaismotais Linksys logotips izdziest un sāk mirgot zilie MU-NIMO indikatori (aptuveni 10 sekundes). Instalējiet maršrutētāju vēlreiz.

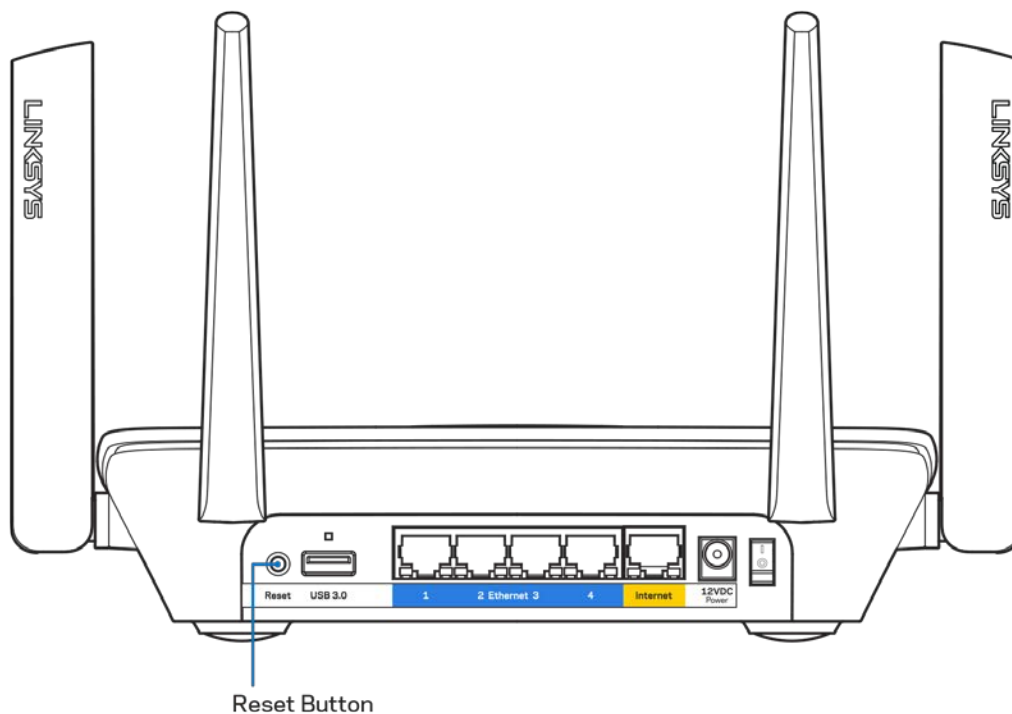

- Uz laiku atslēdziet sava datora ugunsdmūri (palīdzībai skatiet norādījumus par drošības programmatūru). Instalējiet maršrutētāju vēlreiz.
- Ja jums ir cits dators, izmantojiet šo datoru, lai instalētu maršrutētāju no jauna.

## Interneta kabelis nav pieslēgts ziņojums

Ja, mēģinot iestatīt savu maršrutētāju, saņemat ziņojumu "Jūsu Internet tīkla kabelis nav pieslēgts", izpildiet šādas problēmu novēršanas darbības.

- Pārliedziet vai Ethernet vai interneta kabelis (vai kabelis, kas līdzīgs ar Jūsu maršrutētāju piegādātajam) ir droši savienots ar dzelteni Interneta portu, kas atrodas maršrutētāja mugurpusē, un ar modēma atbilstošo pieslēgvietu. Šo pieslēgvietu uz modema parasti apzīmē ar Ethernet.

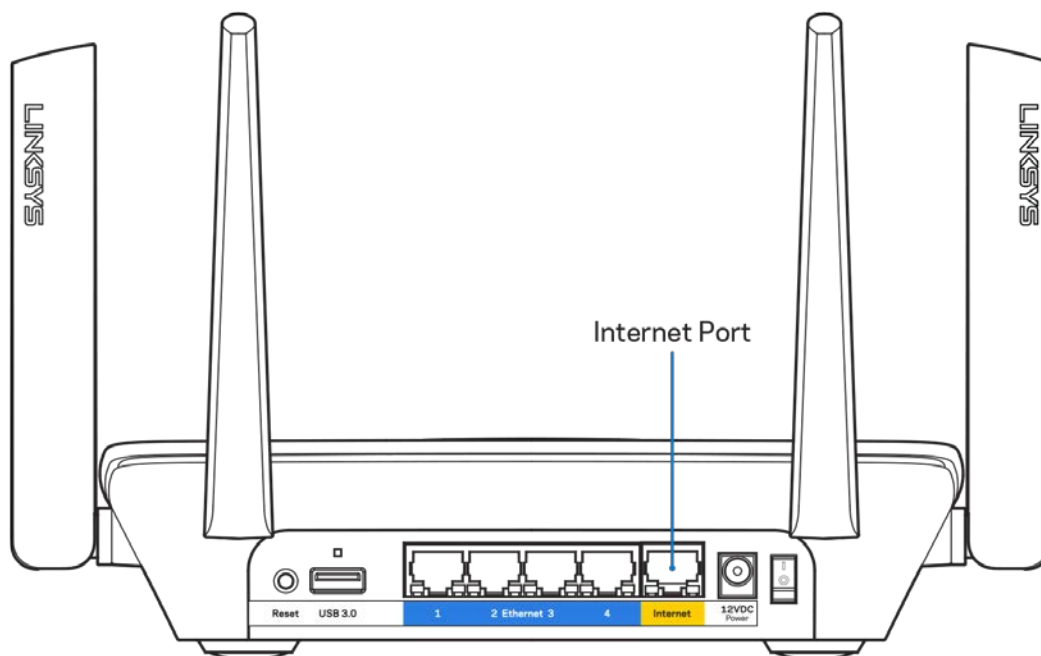

- Pārliedziet, vai jūsu modems ir pieslēgts barošanas avotam un, vai ir ieslēgts. Ja tas ir aprīkots ar barošanas slēdzi, pārliedziet, vai tas atrodas ieslēgtā stāvoklī ON vai I (pretēji O).

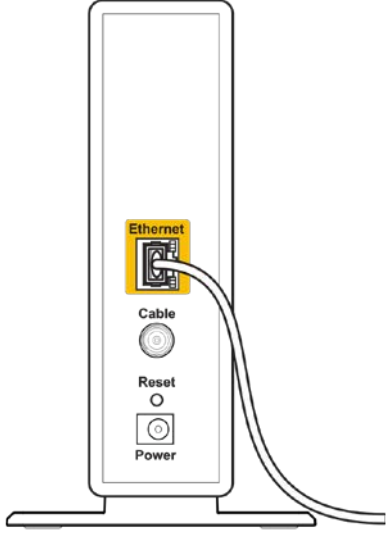
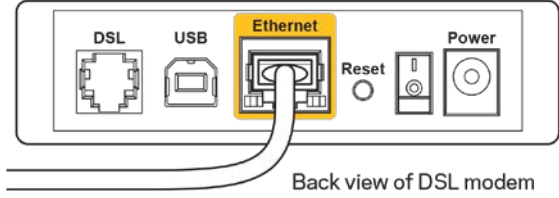

 <p>Back view of cable modem</p>	 <p>Back view of DSL modem</p>
<p>Ja jūs interneta pieslēgumu saņemat pa kabeli, pārliecinieties, vai kabeļa modema pieslēgvietā CABLE (KABELIS) ir pievienota jūsu ISP piegādātajam koaksiālajam kabelim.</p>	<p>Vai arī, ja saņemat DSL interneta pieslēgumu, pārliecinieties, vai jūsu DSL tālruņa līnija ir pieslēgta modema DSL pieslēgvietai.</p>

- Ja jūsu dators iepriekš bija pieslēgts jūsu modenam ar USB kabeļa palīdzību, atvienojiet USB kabeli.
- Instalējiet maršrutētāju vēlreiz.

## ***Nav piekļuves maršrutētājam ziņojums***

Lai piekļūtu maršrutētājam, jābūt izveidotam pieslēgumam jūsu pašu tīklam. Ja Jums ir bezvadu Interneta piekļuve, iespējams, ka problēma rodas, jo jau esat nejauši savienots ar citu bezvadu tīklu.

Lai atrisinātu šo problēmu datoros ar Windows, rīkojieties šādi\*:

1. Sistēmas paliktnī noklikšķiniet uz bezvadu ikonai. Ekrānā redzams pieejamo tīklu saraksts.

2. Noklikšķiniet uz sava bezvadu tīkla nosaukuma. Noklikšķiniet Connect (Savienot). Zemāk redzamajā piemērā dators ir savienots ar citu bezvadu tīklu ar nosaukumu wraith\_5GHz. Šajā piemērā, kā parādīts, atlasītā Linksys EA8300 maršrutētāja bezvadu tīkla nosaukums ir Damaged\_Beez2.4.



3. Ja jūs saņemat ziņojumu, ka jāievada tīkla drošības atslēga, ierakstiet savu paroli (drošības atslēgu) lauciņā security key. Noklikšķiniet **OK (Labi)**.
4. Jūsu dators izveido savienojumu ar tīklu, un jums ir iespēja piekļūt maršrutētājam.

*\*Atkarībā no jūsu Windows versijas šajās darbībās nedaudz var atšķirties formulējums vai ikonas.*

Lai šo problēmu atrisinātu Mac datoros, rīkojieties šādi:

1. Izvēlnes joslā ekrāna augšdaļā noklikšķiniet uz Wi-Fi piktogrammas. Tiek parādīts bezvadu tīklu saraksts.
2. Zemāk redzamajā piemērā dators ir savienots ar citu bezvadu tīklu ar nosaukumu wraith\_5GHz. Šajā piemērā, kā parādīts, atlasītā Linksys EA8300 maršrutētāja bezvadu tīkla nosaukums ir Damaged\_Beez2.4.



3. Noklikšķiniet uz Jūsu Linksys EA8300 maršrutētāja bezvadu tīkla nosaukuma (piemērā Damaged\_Beez2.4).
4. Ievadiet savu bezvadu tīkla paroli (drošības atslēgu) *Password* laukā. Noklikšķiniet **OK (Labi)**.

## Pēc iestatīšanas

### Šķiet, ka internets nav pieejams

Ja internets nevar sazināties ar Jūsu maršrutētāju, Jūsu interneta pārlūkā problēma var tikt attēlota kā ziņojums "Nav iespējams atrast [interneta adresi]". Ja zināt, ka interneta adrese ir pareiza, un ja esat izmēģinājis vairākas derīgas interneta adreses, iegūstot to pašu rezultātu, tad šis paziņojums varētu nozīmēt to, ka jūsu ISP vai modemam ir grūtības sazināties ar jūsu maršrutētāju. Mēģiniet veikt tālāk norādītās darbības:

- pārbaudiet, vai tīkla un barošanas kabeli ir cieši pievienoti;
- pārbaudiet, vai barošanas izejā, pie kuras ir pieslēgts maršrutētājs, ir elektrība;
- atsāknējiet datoru;
- sazinieties ar savu ISP un jautājiet par darbības pārtraukumiem jūsu rajonā.

Visizplatītākā maršrutētāja problēmu novēršanas metode ir to izslēgt, un pēc tam atkal ieslēgt. Pēc tam maršrutētājs var atkal ielādēt standarta iestatījumus, un citas ierīces (tādas kā modems) varēs atkal atrast maršrutētāju un sazināties ar to. Šo procesu sauc par atsāknēšanu.

Lai atsāknētu maršrutētāju, izmantojot barošanas vadu, rīkojieties šādi:

1. atvienojiet barošanas vadu no maršrutētāja un modema.
2. Pagaidiet 10 sekundes, un tad no jauna pievienojiet barošanas vadu pie modema. Pārbaudiet, vai tam pienāk elektrība.
3. Uzgaidiet, līdz modema tiešsaistes indikators pārstāj mirgot (aptuveni divas minūtes). No jauna pievienojiet barošanas vadu pie maršrutētāja.
4. Gaidiet, līdz izgaismojas Linksys logotips. Pagaidiet divas minūtes, pirms cenšaties pieslēgties internetam no kāda datora.

Lai atsāknētu maršrutētāju, izmantojot sistēmu Linksys Smart Wi-Fi, rīkojieties šādi:

1. piesakieties sistēmā Linksys Smart Wi-Fi (Skatiet sadaļu "Kā pieslēgties Linksys Smart Wi-Fi" [11.](#) lappusē)
2. izvēlnē *Router Settings* (Maršrutētāja iestatījumi) noklikšķiniet *Troubleshooting* (Problēmu novēršana);
3. noklikšķiniet cilni *Diagnostics* (Diagnostika);
4. *Sadaļā* Reboot (Atsāknēt) noklikšķiniet Reboot (Atsāknēt).



5. Noklikšķiniet **Yes (Jā)**. Maršrutētājs atsāknēsies. Kamēr maršrutētājs atsāknējas, visas pieslēgtās ierīces zaudē interneta pieslēgumu, un tās automātiski pieslēgsies no jauna, kad maršrutētājs būs atkal gatavs.

## Jūsu tīmekļa pārlūkā neatveras sistēma Linksys Smart Wi-Fi

Jaunākās Google Chrome™, Firefox®, Safari® (Mac® and iPad®), Microsoft Edge versijas un Internet Explorer® 8 un jaunākas versijas atbalsta Linksys Smart Wi-Fi.

# Specifikācijas

## Linksys EA8300

Modeļa nosaukums	Maksimālas straumēšanas AC2200 MU-MIMO trīsjoslu maršrutētājs
Modeļa numurs	EA8300
Pieslēgumu pieslēgvietas ātrums	10/100/1000 Mbps (gigabita <i>Ethernet</i> )
Radio frekvence	2,4 GHz un 5 GHz (x2)
Antenu #	4 ārējas pielāgojamas antenas (nav atvienojamas)
Pieslēgvietas	USB 3.0, Ethernet (1-4), Internets, Barošana
Pogas	Wi-Fi Protected Setup, Jauda, Atiestatīšana
Gaismas	<b>Viršējais panelis:</b> Izgaismots Linksys logotips, Wi-Fi Protected Setup, Interneta savienojums, tīkla kabeļa savienojums ar interneta pieslēgvietu <b>Aizmugurējais panelis:</b> USB, Ethernet (1-4), Internets
UPnP	atbalstītas
drošības funkcijas	WEP, WPA2, RADIUS
Drošības atslēgas biti	Līdz 128 bitu šifrs
Uzglabāšanas datņu sistēmas atbalsts	FAT, NTFS, un HFS+
Pārlūka atbalsts	Google Chrome™, Firefox®, Safari® (ar Mac® un iPad®), Microsoft Edge jaunākās versijas, Internet Explorer® 8. versija un jaunākas.

## Vide

Izmēri	213,7mm x 161,8mm x 54,8mm (bez antenām)
Ierīces svars	608 g
Barošana	12V, 2A
Sertifikāti	FCC, IC, CE, Wi-Fi (a/b/g/n/ac)
Darba vides temperatūra	no 32 līdz 104°F (no 0 līdz 40°C)
Uzglabāšanas vides temperatūra	-4-140 °F (-20-60 °C)
Darba vides mitrums	10% līdz 80% relatīvā mitruma, bez kondensācijas
Uzglabāšanas vides mitrums	5% līdz 90% bez kondensācijas

Specifikācijas var tikt mainītas bez iepriekšēja brīdinājuma.

## Piezīmes

Regulatoro, garantijas un drošuma informāciju skatiet CD, kas tika piegādāts kopā ar Jūsu maršrutētāju, vai apmeklējiet interneta vietni [Linksys.com/support/EA8300](http://Linksys.com/support/EA8300).

Maksimālie darbības lielumu pamats ir IEEE Standarta 802.11 specifikācijas. Faktiskie darbības lielumi var mainīties, tostarp iespējama mazāka bezvadu tīkla kapacitāte, datu pārraides ātrums, amplitūda un pārklājums. Darbība ir atkarīga no daudziem faktoriem, apstākļiem un mainīgajiem lielumiem, kas aptver attālumu no piekļuves vietas, tīkla noslogotību, celtniecības materiālus un konstrukcijas, lietoto operētājsistēmu, izmantoto bezvadu ierīču kopumu, traucējumus un citus nelabvēlīgus faktorus.

BELKIN, LINKSYS un daudzi citi produktu nosaukumi un logotipi ir Belkin uzņēmumu grupas preču zīmes. Minētās trešo personu preču zīmes ir to atbilstīgo īpašnieku īpašums. Šajā izstrādājumā izmantotās trešo personu programmatūras licences un paziņojumi ir aplūkojami šeit: <http://support.linksys.com/en-us/license>. Jautājumu vai GPL avota kodu pieprasījumu gadījumā, lūdzu, sazinieties ar <http://support.linksys.com/en-us/gplcodecenter>.

© 2017 Belkin International, Inc. un/vai tā filiāles. Visas tiesības saglabātas.

**LINKSYS®**

Gebruikershandleiding

**MAX-STREAM™  
AC2200 MU-MIMO  
TRI-BAND-ROUTER**

Artikelnummer EA8300

# Inhoud

Productoverzicht .....	3
Bovenaanzicht .....	3
Systeemstatuslampjes .....	4
Achteraanzicht .....	5
Zijaanzicht.....	6
Installatie: basisinstructies .....	7
Waar kan ik meer hulp vinden? .....	7
Uw router installeren.....	8
Linksys Smart Wi-Fi gebruiken .....	11
Verbinding maken met Linksys Smart Wi-Fi .....	11
Netwerktoeewijzing .....	12
Gasttoegang.....	12
Ouderlijk toezicht .....	13
Mediaprioritering.....	13
Snelheidstest.....	14
Externe opslag.....	14
Connectiviteit .....	15
Problemen oplossen .....	15
Draadloos .....	16
Beveiliging.....	16
Problemen oplossen.....	17
De installatie van de router was niet succesvol .....	17
Melding <i>Uw internetkabel is niet aangesloten</i> .....	18
Melding <i>"Geen toegang tot uw router"</i> .....	19
Na de installatie.....	21
Het internet lijkt niet beschikbaar .....	21
Linksys Smart Wi-Fi opent niet in uw webbrowser.....	22
Specificaties.....	23
Linksys EA8300 .....	23
Omgevingspecificaties.....	23



# Productoverzicht

## Bovenaanzicht

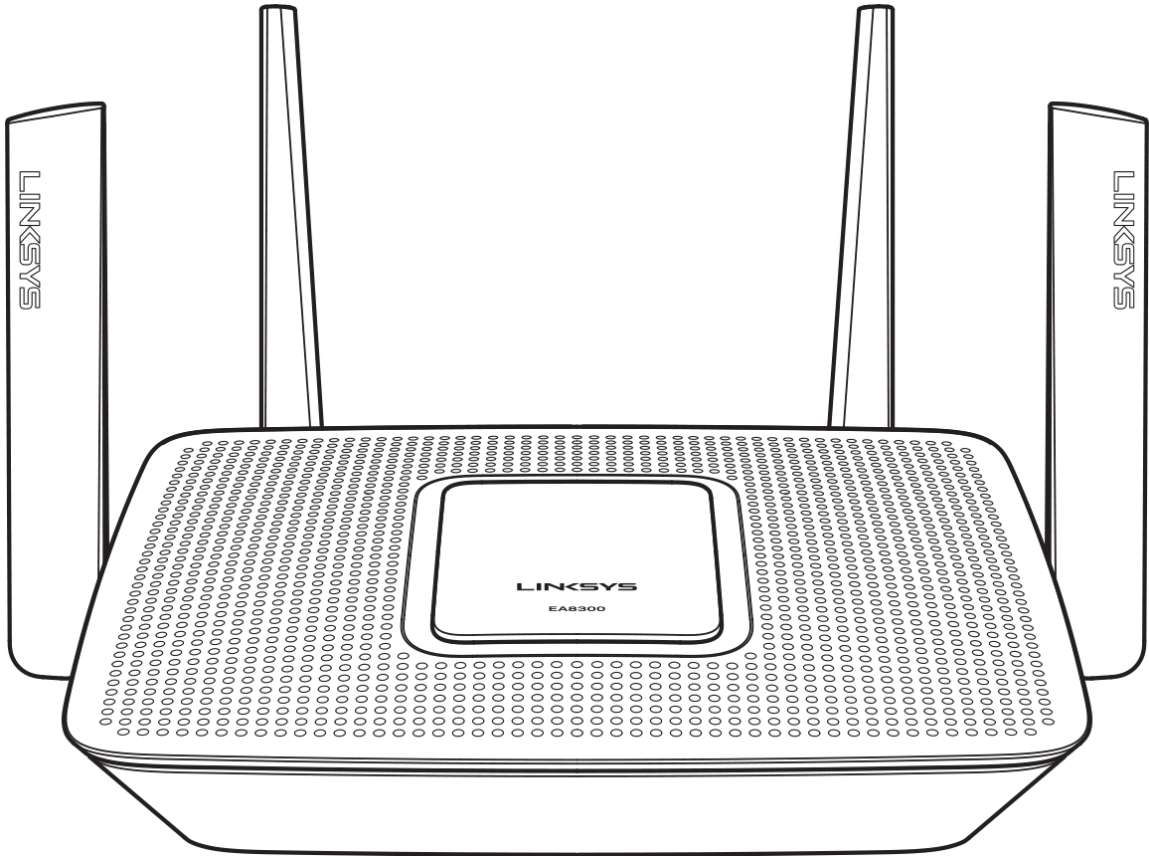

## Systeemstatuslampjes

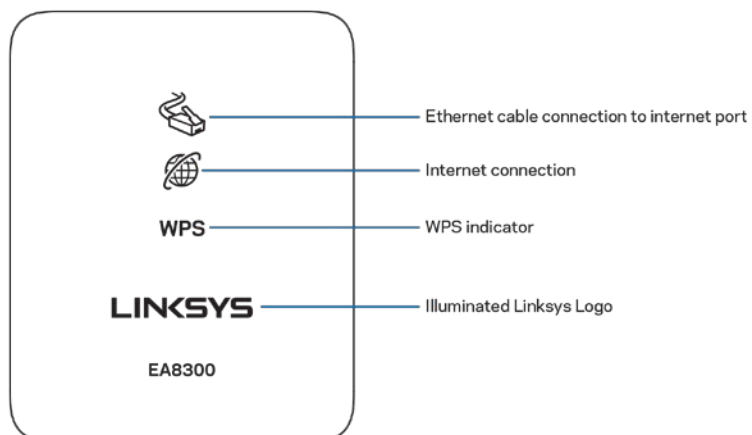

**Ethernet-kabelaansluiting:** Als het lampje brandt (oranje), is er een probleem met de netwerkkabel die op de Internet (WAN)-poort is aangesloten

**Internetverbinding:** Als het lampje brandt (oranje), kan de router geen verbinding met het internet maken.

**WPS (Wi-Fi Protected Setup™):** Het WPS-lampje kan vier verschillende situaties aanduiden:

<b>Uit</b>	Geen Wi-Fi Protected Setup-activiteit
<b>Wit, knippert</b>	Bezig met Wi-Fi Protected Setup
<b>Wit, brandt continu</b>	Wi-Fi Protected Setup is met succes afgerond; het lampje blijft vijf seconden branden
<b>Knippert oranje</b>	Wi-Fi Protected Setup-fout; het lampje knippert gedurende een minuut en gaat daarna uit

**Lampje Linksys-logo:** Het lampje knippert terwijl de router opstart. Wanneer het logo wit brandt, is de router ingeschakeld en werkt hij correct.

## Achteraanzicht

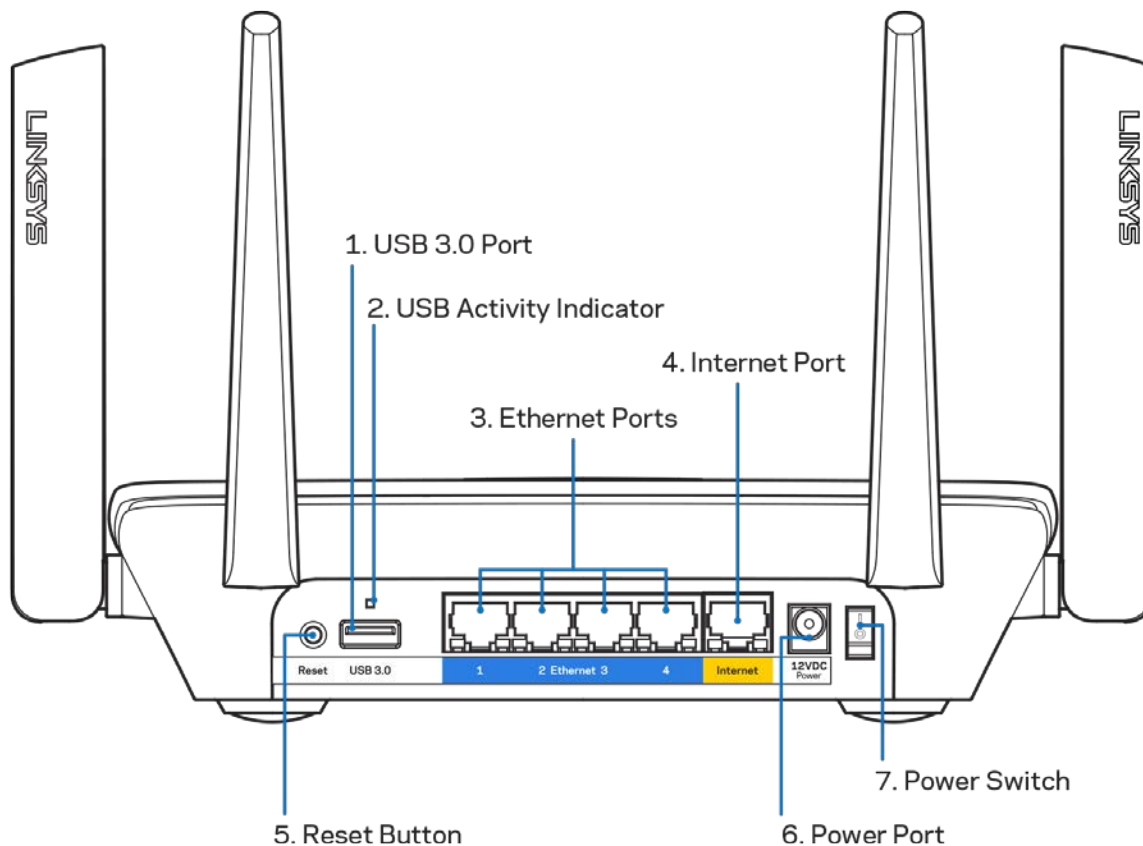

**USB 3.0-poort (1):** Sluit USB-stations aan om deze te delen op uw netwerk of het internet.

**Lampje USB-activiteit (2):** Een brandend lampje geeft aan dat er gegevensoverdracht plaatsvindt van of naar een extern apparaat

**Ethernet-poorten (3):** Sluit Ethernet-kabels aan op deze blauwe Gigabit-poorten (10/100/1000) en op de apparaten die u via deze kabels met uw netwerk wilt verbinden.

**Opmerking:** *Gebruik voor de beste prestaties CAT5e-kabels of hoger voor het aansluiten van apparaten op de Ethernet-poorten.*

**Internetpoort (4):** Sluit een Ethernet-kabel aan op deze gele Gigabit-poort (10/100/1000) en op een breedbandinternetkabel- ADSL- of glasvezelmodem.

**Opmerking:** *Gebruik voor de beste prestaties een CAT5e-kabel of hoger voor het aansluiten van apparaten op de Internet-poort.*

**Resetknop (5):** Om de fabrieksinstellingen te herstellen, houdt u deze knop ingedrukt tot het lampje van het Linksys-logo begint te knipperen. U kunt de fabrieksinstellingen ook terugzetten met behulp van Linksys Smart Wi-Fi op het internet of via de mobiele app.

**Voedingsaansluiting (6):** Sluit de meegeleverde wisselstroomadapter aan op deze poort.

**Aan/uit-schakelaar (7):** Druk op | (on (aan)) om de router aan te zetten.

## Zijaanzicht

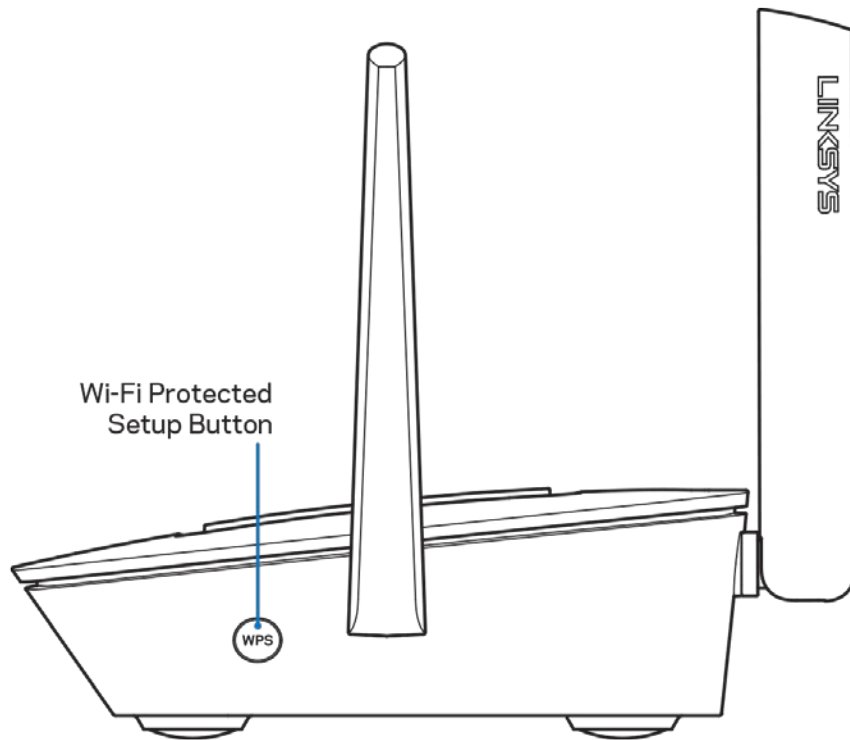

**Wi-Fi Protected Setup™-knop:** Druk op deze knop om verbinding te maken met netwerkapparaten met WPS-ondersteuning.

# Installatie: basisinstructies

## Waar kan ik meer hulp vinden?

Voor aanvullende informatie op deze handleiding verwijzen wij u naar:

- [Linksys.com/support/EA8300](http://Linksys.com/support/EA8300) (documentatie, downloads, veelgestelde vragen, technische ondersteuning, live chatten, forums)
- Linksys Smart Wi-Fi Help (maak verbinding met Linksys Smart Wi-Fi en klik bovenin het scherm op Help)

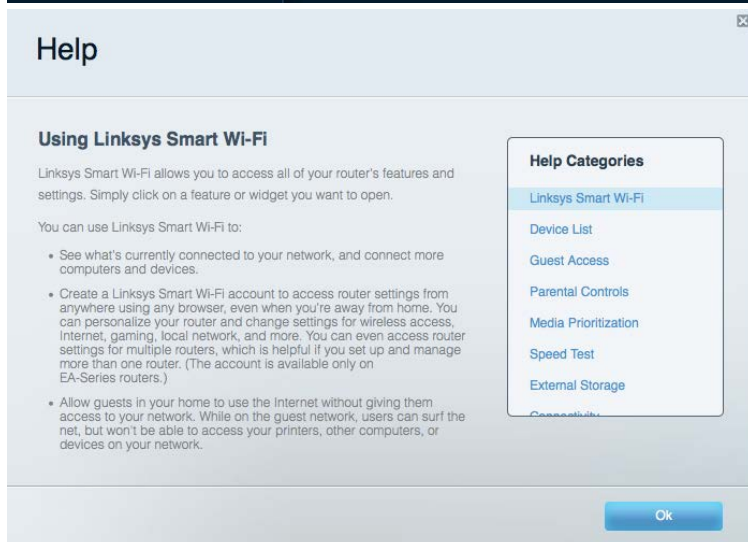
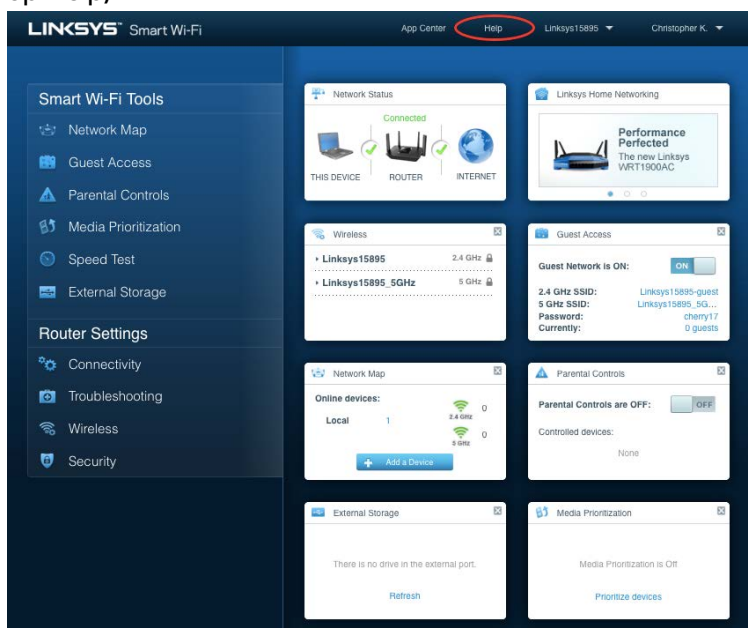

**Let op:** Licenties en kennisgevingen voor software van derden die gebruikt worden voor dit product, vindt u op <http://support.linksys.com/en-us/license>. Voor vragen of verzoeken om de GPL-broncodebestanden kunt u contact opnemen via <http://support.linksys.com/en-us/gplcodecenter>.

## Uw router installeren

1. Voor de installatie heeft u een computer nodig. Hierop moet u in een webbrowser naar <http://LinksysSmartWiFi.com> gaan.
2. Welke apparatuur heeft u?

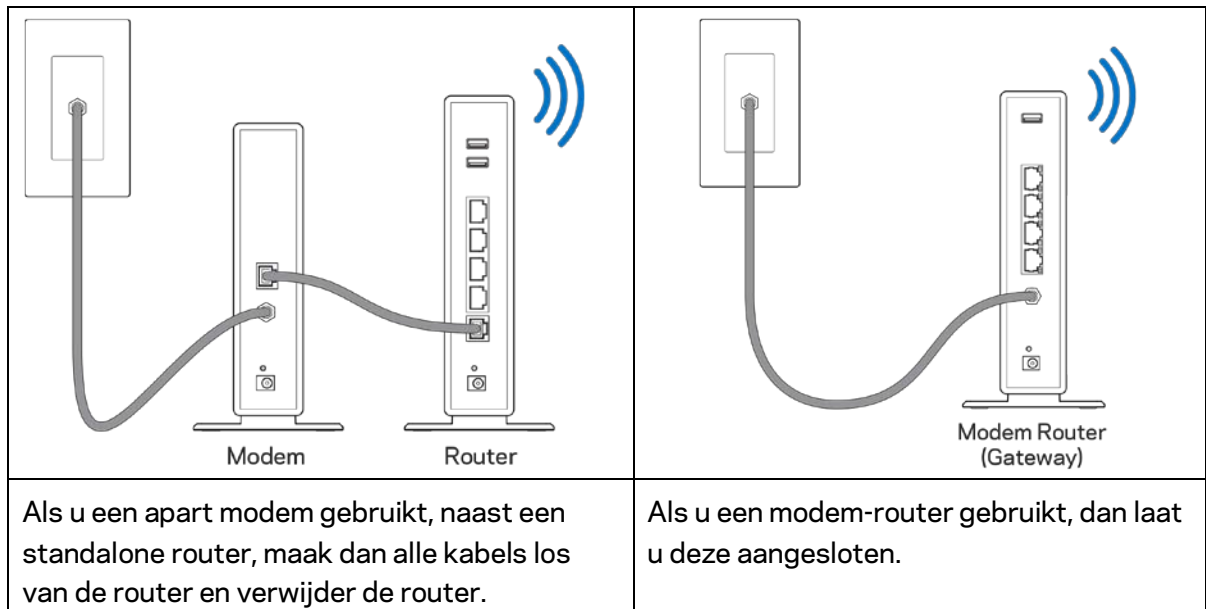

3. Zet de antennes rechtop en sluit de router aan op een voedingsbron. Zorg ervoor dat de voedingsschakelaar op | (on (aan)) staat.
4. Sluit uw router aan op uw modem of modem-router. Sluit het ene uiteinde van de meegeleverde internetkabel aan op de gele internetpoort van uw nieuwe router. Als u een modem heeft, sluit u het andere uiteinde aan op de Ethernet (LAN)-poort op de achterkant van het modem. Als u een modem-router heeft, dan sluit u de kabel aan op een beschikbare poort.
5. Wacht tot het lampje van het Linksys-logo boven op uw router stopt met knipperen en wit blijft branden.
6. Maak verbinding met het beveiligde draadloze netwerk. De naam van dit Wi-Fi-netwerk vindt u in de snelstartgids die met uw router meegeleverd is. (U kunt deze gegevens later wijzigen.) Als u hulp nodig heeft bij het verbinden maken met het netwerk, raadpleeg dan de bij het apparaat horende documentatie op [linksys.com/support/ea8300](http://linksys.com/support/ea8300).

**Opmerking:** U heeft pas toegang tot het internet als de configuratie van de router is voltooid.

7. Voer <http://LinksysSmartWiFi.com> in een webbrowser in. Volg de instructies op het scherm om de installatie van de router te voltooien. U kunt de installatie ook starten door in uw browser naar 192.168.1.1 te gaan.

Na de installatie volgt u de instructies op het scherm om uw Linksys Smart Wi-Fi-account in te stellen. Gebruik Linksys Smart Wi-Fi om uw router te configureren vanaf een willekeurige computer met een internetverbinding.

Beheer de instellingen van uw router:

- Wijzig de naam en het wachtwoord van uw router
- Gasttoegang instellen;
- Ouderlijk toezicht configureren;
- Verbind apparaten met uw Wi-Fi
- Test de snelheid van uw internetverbinding

**Opmerking:** *Bij het instellen van uw Linksys Smart Wi-Fi-account wordt er een controle-e-mail naar u gestuurd. Klik vanuit uw thuisnetwerk op de link in de e-mail om uw router te koppelen met uw Linksys Smart Wi-Fi-account.*

**Tip:** *Druk de volgende pagina af en noteer de instellingen van uw router en account in de tabel. Bewaar deze gegevens op een veilige plaats.*

Naam 2,4GHz-Wi-Fi	
Wi-Fi-wachtwoord	
Naam 5GHz-Wi-Fi <sub>1</sub>	
Wi-Fi-wachtwoord	
Naam 5GHz-Wi-Fi <sub>2</sub>	
Wi-Fi-wachtwoord	
Wachtwoord router	
Naam 2,4 GHz-Wi-Fi-gastnetwerk	
Naam 5GHz-Wi-Fi-gastnetwerk	
Wachtwoord Wi-Fi-gastnetwerk (het wachtwoord voor de beide gastnetwerken is gelijk)	
Gebruikersnaam Linksys Smart Wi-Fi	
Wachtwoord Linksys Smart Wi-Fi	



# Linksys Smart Wi-Fi gebruiken

U kunt uw router overal ter wereld beheren met behulp van Linksys Smart Wi-Fi, maar u kunt dit ook rechtstreeks vanuit uw thuisnetwerk doen. Linksys Smart Wi-Fi is mogelijk ook beschikbaar voor uw mobiele apparaat. Ga naar de app store op uw apparaat voor meer informatie.

## Verbinding maken met Linksys Smart Wi-Fi

Ga als volgt te werk om verbinding te maken met Linksys Smart Wi-Fi:

1. Open de webbrowser op uw computer.
2. Ga naar <http://LinksysSmartWiFi.com> en log in op uw account.

Linksys Smart Wi-Fi Sign In

If you have not yet created a Linksys Smart Wi-Fi account, click the "Create Account" button in the upper right corner of the page.

Give guests Internet access

Use your Linksys Smart Wi-Fi account to access your home network from anywhere, at any time, even from your mobile device. Easily connect new devices, set parental controls, get access to Smart Wi-Fi mobile Apps, and more.

For more information [click here](#)

English (United States)

For local access, [click here](#).

Als u uw wachtwoord niet meer weet, klik dan op *Forgot your password?* (*Uw wachtwoord vergeten?*) en volg de instructies op het scherm om uw wachtwoord opnieuw in te stellen.

# Netwerktoewijzing

Hier kunt u alle netwerkapparaten die verbonden zijn met uw router bekijken en beheren. U kunt apparaten op uw hoofdnetwerk en op uw gastnetwerk bekijken en informatie over elk apparaat weergeven.



# Gasttoegang

Hier kunt u een netwerk configureren en bewaken dat gasten kunnen gebruiken zonder dat ze toegang hebben tot persoonlijke gegevens.

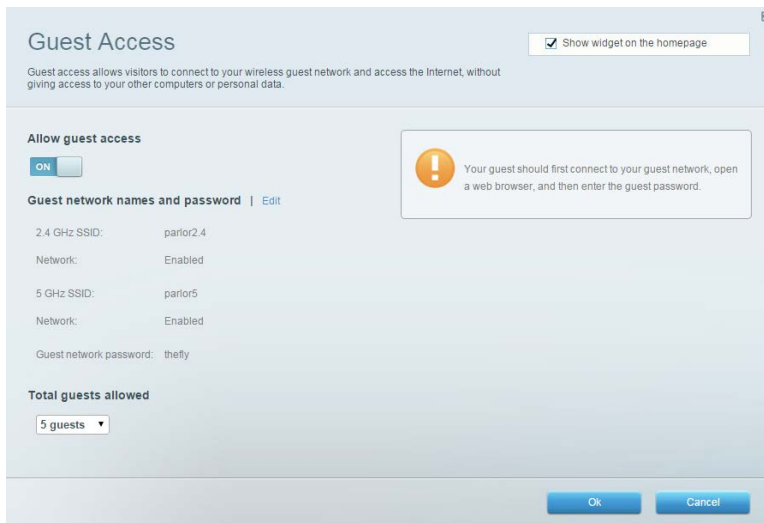

## Ouderlijk toezicht

Hier kunt u websites blokkeren en internettoegangstijden instellen.

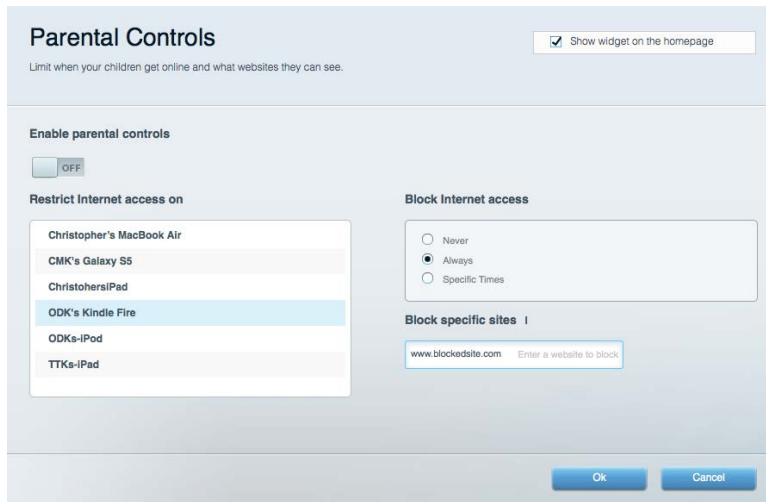

## Mediaprioritering

Hier kunt u instellen welke apparaten en toepassingen de hoogste prioriteit hebben in uw netwerkverkeer.

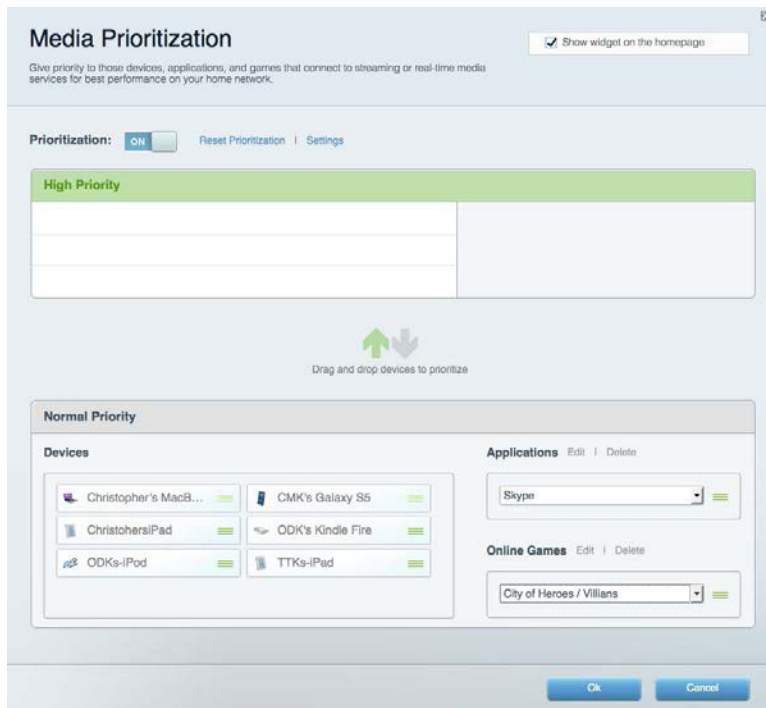

## Snelheidstest

Hiermee kunt u de snelheid van de internetverbinding van uw netwerk testen.



## Externe opslag

Hier kunt u toegang krijgen tot een aangesloten USB-opslagapparaat (niet meegeleverd) en bestandsdeling, een mediaserver en FTP-toegang instellen.

The image shows an 'External Storage' configuration window with the following details:

- External Storage Drive:** Shows 'External storage volume name: ROUND DRIVE' and a progress bar indicating 'Space used: 886 MB used of 960 MB total.' Buttons for 'Safely remove drive' and 'Refresh' are present.
- Folder Access:** 'Secure Folder Access is OFF'. Note: 'Any user can access content via shared folders.' It lists 'PC access (File explorer): \\192.168.1.1' and 'Mac access (Finder): smb://192.168.1.1'.
- FTP Server:** 'FTP Server is OFF'. Note: 'Content is not accessible to any user via FTP.' It shows 'FTP server: Disabled'.
- Media Server (DLNA):** 'Media Server (DLNA) is ON'. Note: 'Media content is accessible to DLNA clients.' It shows 'DLNA server: EA6050'.
- Buttons:** 'Show widget on the homepage' (checked), 'Ok'.

## Connectiviteit

Hier kunt u basisinstellingen en geavanceerde netwerkinstellingen bekijken en wijzigen.

The screenshot shows the 'Connectivity' settings page. It has a title bar with a close button and a subtitle 'View and change router settings'. Below the title bar are tabs for 'Basic', 'Internet Settings', 'Local Network', 'Advanced Routing', 'VLAN', and 'Administration'. The 'Basic' tab is selected. The page is divided into several sections: 'Network Name and Password' with fields for 2.4 GHz and 5 GHz network names and passwords; 'Router Password' with a masked password field; 'Router Firmware Update' with a checked 'Automatic' option and a 'Check for Updates' button; 'Time Zone' with a dropdown menu set to '(GMT-05:00) Eastern Time (USA & Canada)' and a checked 'Automatically adjust for Daylight Savings Time' option; and 'Activity Lights' with an 'ON' toggle and a text box explaining the power light behavior. At the bottom are 'Ok', 'Cancel', and 'Apply' buttons.

## Problemen oplossen

Hier kunt u de oorzaak van problemen met uw router opsporen en de status van het netwerk controleren.

The screenshot shows the 'Troubleshooting' page. It has a title bar with a close button and a subtitle 'Troubleshoot router settings'. Below the title bar are tabs for 'Status', 'Diagnostics', and 'Logs'. The 'Diagnostics' tab is selected. The page is divided into several sections: 'Ping IPv4' with input fields for IP or host name and number to ping, and a 'Start to Ping' button; 'Trace route' with an input field for IP or host name and a 'Start to Traceroute' button; 'Reboot' with a 'Reboot the router' link; 'Router configuration' with 'Backup' and 'Restore' buttons; 'Router Firmware' with a 'Restore previous firmware' button; 'Internet Address' showing IPv4 and IPv6 addresses with 'Release and Renew' links; and 'Factory reset' with a 'Reset to factory default settings' link. At the bottom is an 'Ok' button.

## Draadloos

Hier kunt u het draadloze netwerk van uw router bekijken en wijzigen. U kunt netwerknamen, de beveiligingsmodus, het wachtwoord en MAC-filters wijzigen en apparaten verbinding laten maken met Wi-Fi Protected Setup™.

The screenshot shows the 'Wireless' settings page. At the top, there is a 'Show widget on the homepage' checkbox which is checked. Below this, there are tabs for 'Wireless', 'MAC Filtering', and 'Wi-Fi Protected Setup'. The 'Smart Connect' section has two radio buttons: '5 GHz band steering' (selected) and 'Off'. Below this, there are two network configuration sections. The first is for the 2.4 GHz network, with 'Network name' set to 'arachnid', 'Password' to 'peterparker', 'Broadcast SSID' to 'Yes', 'Security mode' to 'WPA2/WPA Mixed Pt', and 'Network mode' to 'Mixed'. The second is for the 5 GHz network, with 'Network name' set to 'arachnid\_5GHz', 'Password' to 'peterparker', 'Broadcast SSID' to 'Yes', 'Security mode' to 'WPA2/WPA Mixed Pt', and 'Network mode' to 'Auto'. At the bottom, there are 'Ok', 'Cancel', and 'Apply' buttons.

## Beveiliging

Hier kunt u de draadloze beveiliging van uw router bekijken en wijzigen. U kunt de firewall en VPN instellen en specifieke instellingen bepalen voor toepassingen en games.

The screenshot shows the 'Security' settings page. At the top, there is a 'View and change router settings' link. Below this, there are tabs for 'Firewall', 'DMZ', and 'Apps and Gaming'. The 'Firewall' section is active and contains several sub-sections. 'Internet filters' has four checkboxes: 'Filter anonymous Internet requests' (checked), 'Filter multicast' (unchecked), 'Filter Internet NAT redirection' (unchecked), and 'Filter ident (Port 113)' (checked). 'VPN Passthrough' has three checkboxes: 'IPSec Passthrough' (checked), 'PPTP Passthrough' (checked), and 'L2TP Passthrough' (checked). 'IPv6 Port Services' is a table with columns for 'Description', 'Protocol', 'IPv6 Address', 'Allow', and 'Enabled'. Below the table is an 'Add IPv6 Firewall Setting' button. At the bottom, there are 'Ok', 'Cancel', and 'Apply' buttons.

Description	Protocol	IPv6 Address	Allow	Enabled

# Problemen oplossen

Als u meer ondersteuning nodig heeft, kunt u terecht bij onze bekronde klantondersteuning via [linksys.com/support/EA8300](https://linksys.com/support/EA8300).

## De installatie van de router was niet succesvol

U kunt de volgende dingen proberen als de installatie via Linksys Smart Wi-Fi niet gelukt is:

- Druk de resetknop op uw router in met een paperclip of speld totdat het lampje van het Linksys-logo uitgaat en de blauwe MU-MIMO-lampjes gaan knipperen (ongeveer 10 seconden). Installeer de router opnieuw.

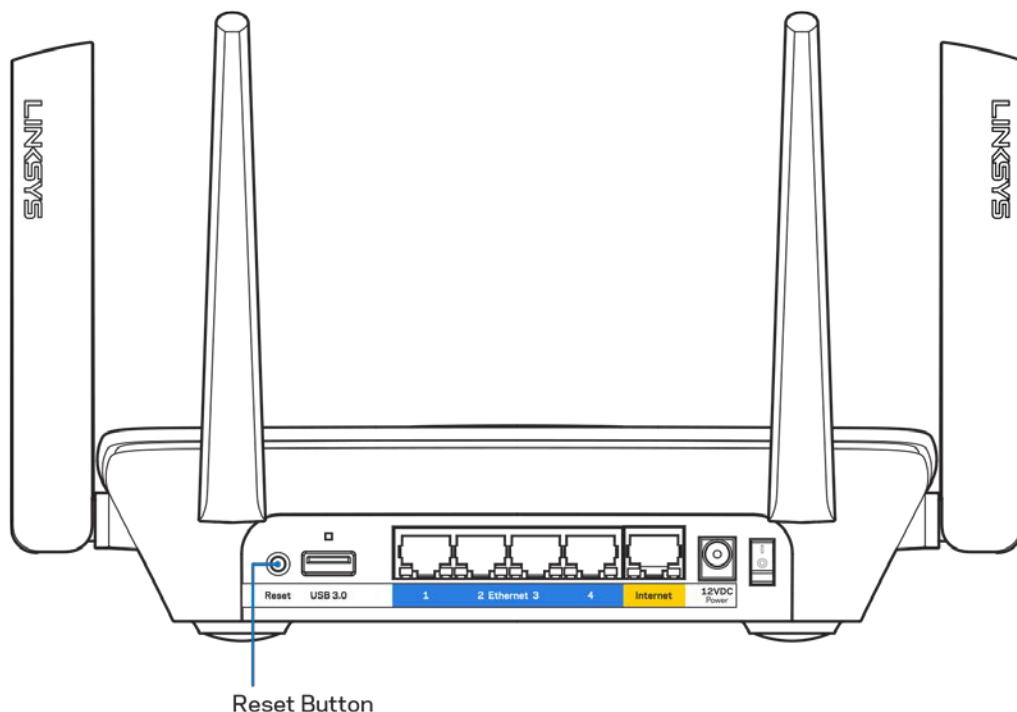

- Schakel de firewall van uw computer tijdelijk uit (raadpleeg de handleiding van de beveiligingssoftware voor meer informatie). Installeer de router opnieuw.
- Als u een andere computer tot uw beschikking heeft, gebruik deze dan om de router opnieuw te installeren.

## Melding *Uw internetkabel is niet aangesloten*

Als u de melding "Uw internetkabel is niet aangesloten" krijgt als u uw router probeert te installeren, volg dan de volgende stappen.

- Controleer of er een Ethernet- of internetkabel (of een kabel zoals die bij uw router is meegeleverd) goed is aangesloten op de gele internetpoort aan de achterkant van de router en op de juiste poort van uw modem. Deze poort op het modem wordt meestal met "Ethernet" aangeduid.

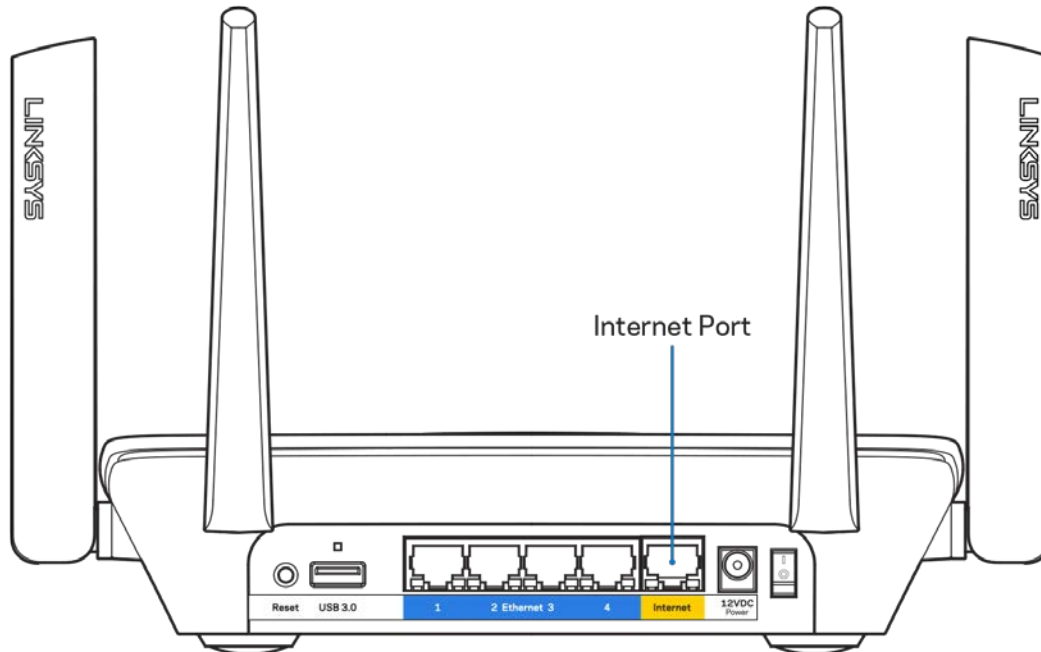

- Controleer of uw modem op het stopcontact is aangesloten en aanstaat. Als het een aan/uit-knop heeft, controleer dan of deze op ON (AAN) of I (en niet op O (UIT)) staat.

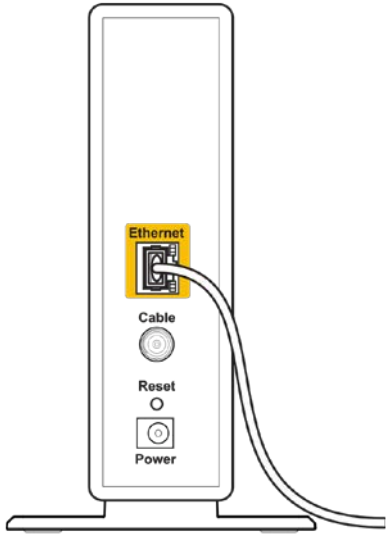
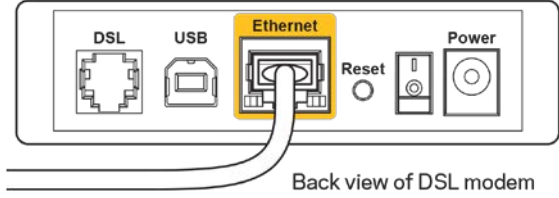

 <p>Back view of cable modem</p>	 <p>Back view of DSL modem</p>
<p>Als u internet via de kabel heeft, controleer dan of de poort CABLE (KABEL) van uw kabelmodem is verbonden met de coaxkabel van uw internetprovider.</p>	<p>Als u DSL-internet heeft, controleer dan of de DSL-telefoonlijn is aangesloten op de DSL-poort van uw modem.</p>

- Als uw computer eerder met een USB-kabel op uw modem was aangesloten, ontkoppel dan de USB-kabel.
- Installeer de router opnieuw.

## Melding *"Geen toegang tot uw router"*

Om toegang te krijgen tot uw router moet u verbonden zijn met uw eigen netwerk. Als u draadloos toegang tot het internet heeft, kan het probleem zijn dat u per ongeluk verbonden bent met een ander draadloos netwerk.

Op een Windows-computer lost u dit probleem als volgt op\*:

1. Klik in de systeembalk op het pictogram voor draadloze netwerken. Er verschijnt een lijst met beschikbare netwerken.

2. Klik op uw eigen netwerknaam. Klik op "Connect" (Verbinden). In het onderstaande voorbeeld was de computer al verbonden met een ander draadloos netwerk, namelijk "wraith\_5GHz". De naam van het draadloze netwerk van de Linksys EA8300-router, in dit voorbeeld Damaged\_Beez2.4, wordt weergegeven als geselecteerd.



3. Als u wordt gevraagd een netwerkbeveiligingssleutel in te voeren, typ dan uw wachtwoord (beveiligingssleutel) in het daarvoor bestemde veld in. Klik op **OK**.
4. Uw computer zal verbinding maken met het netwerk en u zou nu toegang tot de router moeten hebben.

*\*Afhankelijk van uw Windows-versie kunnen de benamingen of pictogrammen in deze stappen enigszins afwijken.*

Op een Mac-computer lost u dit probleem als volgt op:

1. In de menubalk bovenin het scherm klikt u op het Wi-Fi-pictogram. Er verschijnt een lijst met beschikbare draadloze netwerken.
2. In het onderstaande voorbeeld was de computer al verbonden met een ander draadloos netwerk, namelijk "wraith\_5GHz". De naam van het draadloze netwerk van de Linksys EA8300-router, in dit voorbeeld Damaged\_Beez2.4, wordt weergegeven als geselecteerd.

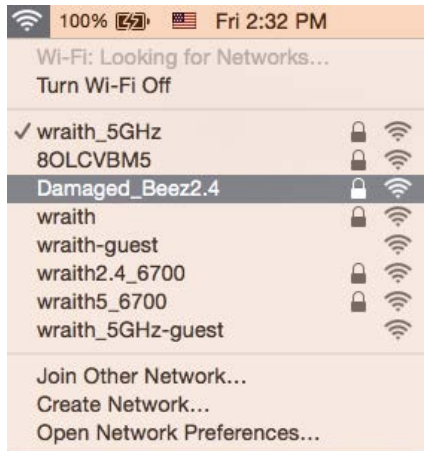

3. Klik op de naam van het draadloze netwerk van uw Linksys EA8300-router (Damaged\_Beez2.4 in dit voorbeeld).
4. Typ het wachtwoord (de beveiligingssleutel) van uw draadloze netwerk in het veld *Password* (Wachtwoord) in. Klik op **OK**.

## Na de installatie

### Het internet lijkt niet beschikbaar

Als het internet moeite heeft om te communiceren met uw router, kan uw webbrowser de foutmelding "Cannot find [internet address]" (Kan [internetadres] niet vinden) geven. Als u zeker weet dat het internetadres juist is en ook andere geldige internetadressen hetzelfde resultaat geven, kan het zijn dat uw internetprovider of modem niet goed communiceert met uw router. Probeer het volgende:

- Controleer of de netwerk- en voedingskabel goed zijn aangesloten.
- Controleer of er stroom staat op het stopcontact waarop uw router is aangesloten.
- Start uw router opnieuw op.
- Neem contact op met uw Internetprovider over storingen in uw regio.

De meest gebruikte manier om problemen met uw router op te lossen is het apparaat uit- en weer aanzetten. Uw router kan dan zijn aangepaste instellingen opnieuw laden en andere apparaten (zoals het modem) kunnen de router opnieuw detecteren en ermee communiceren. Dit proces wordt opnieuw opstarten (rebooting) genoemd.

Ga als volgt te werk uw router opnieuw op te starten met behulp van de voedingskabel:

1. Trek de stekker van de router en het modem uit het stopcontact.
2. Wacht tien seconden en sluit het modem weer aan op netstroom. Controleer of het apparaat werkt.
3. Wacht tot het online-lampje van het modem stopt met knipperen (ongeveer twee minuten). Sluit de router weer aan op netstroom.
4. Wacht tot het lampje van het Linksys-logo blijft branden. Wacht twee minuten voordat u vanaf een computer verbinding probeert te maken met het internet.

Ga als volgt te werk om uw router opnieuw op te starten via Linksys Smart Wi-Fi:

1. Log in op Linksys Smart Wi-Fi. (Zie "Verbinding maken met Linksys Smart Wi-Fi" op pagina [11](#).)
2. Klik onder *Router Settings* (Routerinstellingen) op *Troubleshooting* (Problemen oplossen).
3. Klik op het tabblad *Diagnostics* (Diagnostische gegevens).
4. Klik onder *Reboot* (Opnieuw opstarten) op *Reboot* (Opnieuw opstarten).



5. Klik op **Yes** (Ja). De router start opnieuw op. Terwijl de router opnieuw opstart, verliezen alle aangesloten apparaten hun internetverbinding. Als de router gereed is, maken ze opnieuw verbinding met het internet.

## Linksys Smart Wi-Fi opent niet in uw webbrowser

De nieuwste versies van Google Chrome™, Firefox®, Safari® (voor Mac® en iPad®), Microsoft Edge en Internet Explorer® versie 8 en hoger werken met Linksys Smart Wi-Fi.

# Specificaties

## Linksys EA8300

Productnaam	Max-Stream AC2200 MU-MIMO tri-band-router
Artikelnummer	EA8300
Snelheid van switchpoort	10/100/1000 Mbps (Gigabit Ethernet)
Radiofrequenties	2,4 GHz en 5 GHz (2x)
Aantal antennes	4 externe verstelbare antennes (niet verwijderbaar)
Poorten	USB 3.0, Ethernet (1-4), internet, voeding
Knoppen	Wi-Fi Protected Setup, aan/uit, reset
Lampjes	<b>Bovenpaneel:</b> Linksys-logo, Wi-Fi Protected Setup, internetverbinding, netwerkkabelaansluiting <b>Achterpaneel:</b> USB, Ethernet (1-4), Internet
UPnP	Ondersteund
Beveiligingsfuncties	WEP, WPA2, RADIUS
Beveiligingssleutel	Maximaal 128-bits versleuteling
Ondersteunde bestandssystemen voor opslag	FAT, NTFS en HFS+
Ondersteunde browsers	De nieuwste versies van Google Chrome™, Firefox®, Safari® (voor Mac® en iPad®), Microsoft Edge en Internet Explorer® versie 8 en hoger

## Omgevingspecificaties

Afmetingen	213,7 mm x 161,8 mm x 54,8 mm (zonder antennes)
Gewicht apparaat	608 g
Voeding	12 V, 2 A
Certificering	FCC, IC, CE, Wi-Fi (a/b/g/n/ac)
Gebruikstemperatuur	0 tot 40 °C
Opslagtemperatuur	-20 tot 60 °C
Luchtvochtigheid tijdens gebruik	10 tot 80% relatieve vochtigheid, niet-condenserend
Luchtvochtigheid tijdens opslag	5% tot 90% niet-condenserend

De specificaties kunnen zonder kennisgeving worden gewijzigd.

Opmerkingen:

Raadpleeg de bij uw router meegeleverde cd voor wettelijk verplichte informatie, garantie en veiligheidsvoorschriften of ga naar [Linksys.com/support/EA8300](http://Linksys.com/support/EA8300).

Maximale prestaties zijn afgeleid van de specificaties van de IEEE 802.11-standaard. De werkelijke prestaties kunnen variëren, met een lagere capaciteit van het draadloze netwerk, lagere gegevensdoorvoersnelheden en een bereik en dekking die kleiner zijn. De prestaties hangen af van talrijke factoren, omstandigheden en variabelen, waaronder de afstand tot het accesspoint, het volume van het netwerkverkeer, bouwmaterialen en constructie, gebruikt besturingssysteem, mix van gebruikte draadloze producten, interferentie en andere ongunstige omstandigheden.

BELKIN, LINKSYS en veel andere productnamen en logo's zijn handelsmerken van de Belkin-bedrijvengroep. Vermelde handelsmerken van derden zijn eigendom van hun respectieve eigenaars. Licenties en kennisgevingen voor software van derden die gebruikt worden voor dit product kunt u hier vinden: <http://support.linksys.com/en-us/license>. Voor vragen of de GPL-broncodebestanden kunt u contact met ons opnemen via <http://support.linksys.com/en-us/gplcodecenter>.

© 2017 Belkin International, Inc. en/of zijn gelieerde ondernemingen. Alle rechten voorbehouden.

**LINKSYS®**

Brukerhåndbok

**MAX-STREAM™  
AC2200 MU-MIMO  
TRI-BAND ROUTER**

Model EA8300

# Innhold

Produktoversikt.....	3
Sett ovenfra .....	3
Indikator for systemstatus .....	4
Visning bakfra.....	5
Sett fra siden .....	6
Konfigurering: Grunnleggende.....	7
Her finner du mer hjelp.....	7
Slik installerer du ruterens .....	8
Slik bruker du Linksys Smart Wi-Fi.....	11
Slik kobler du til Linksys Smart Wi-Fi.....	11
Nettverkskart .....	12
Gjestetilgang.....	12
Foreldrekontroll .....	13
Medieprioritering.....	13
Hastighetstest.....	14
Ekstern lagringsplass .....	14
Tilkobling.....	15
Feilsøking.....	15
Trådløst.....	16
Sikkerhet .....	16
Feilsøking.....	17
Ruterens din ble ikke riktig installert .....	17
Melding om at <i>Internett-kabelen ikke er koblet til</i> .....	18
Melding om <i>manglende tilgang til ruterens</i> .....	19
Etter oppsett.....	21
Internett virker å være utilgjengelig.....	21
Linksys Smart Wi-Fi åpner ikke i nettleseren .....	22
Spesifikasjoner .....	23
Linksys EA8300 .....	23
Omgivelser.....	23



# Produktoversikt

## Sett ovenfra

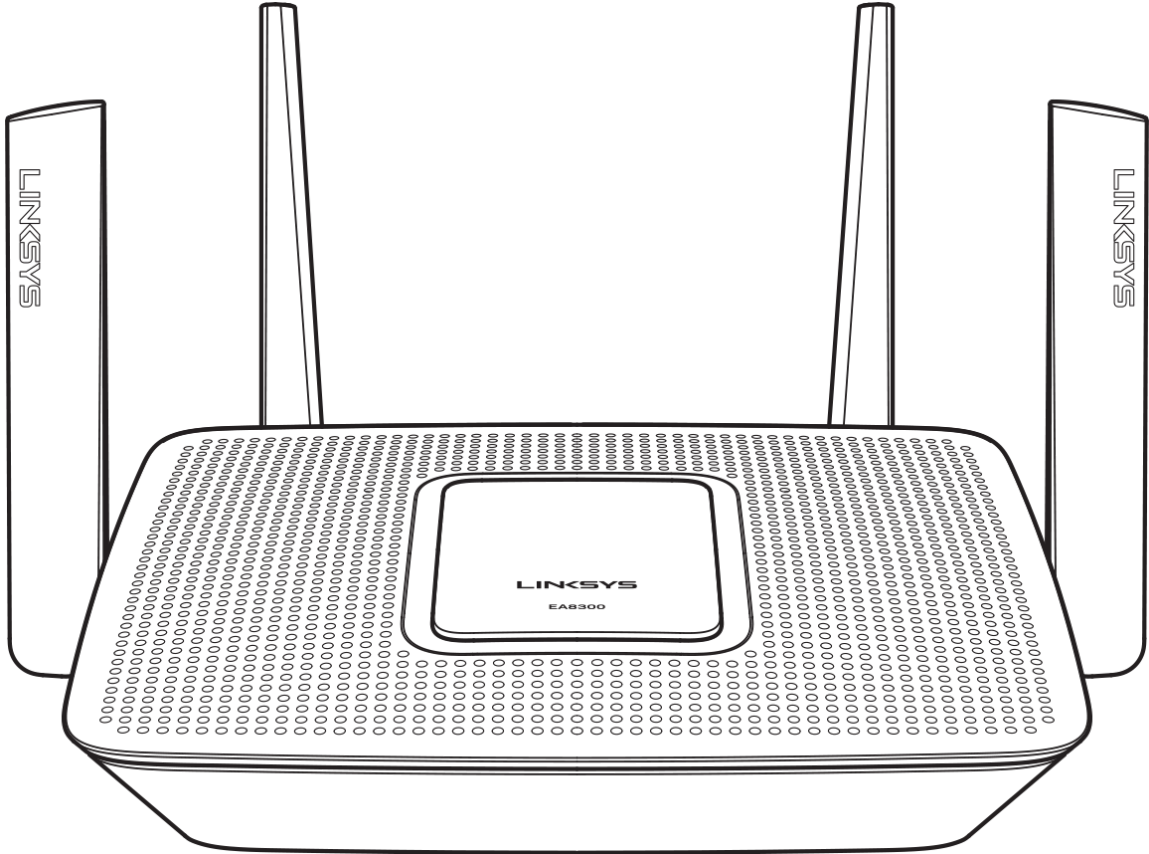

## Indikator for systemstatus

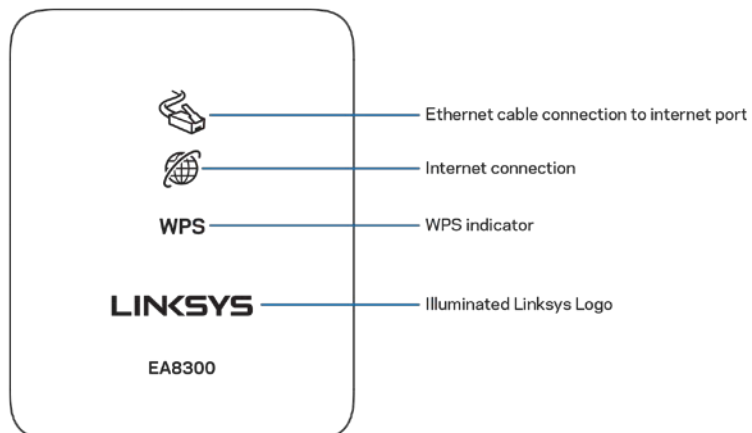

**Tilkobling av Ethernet-kabel til Internett-port**—Når den er tent (oransje), indikerer dette et problem med nettverkskabelen som er koblet til Internett-porten (WAN).

**Internett-tilkobling**—Når den er tent (oransje), indikerer dette at ruterens ikke kan koble til Internett.

**WPS-indikator (Wi-Fi Protected Setup™)**—WPS-lyset har fire tilstander:

<b>Av</b>	Ingen Wi-Fi Protected Setup-aktivitet
<b>Blinkende hvit</b>	Wi-Fi Protected Setup pågår
<b>Fast hvit</b>	Wi-Fi Protected Setup er vellykket. Forblir tent i fem sekunder
<b>Blinkende oransje lys</b>	Feil med Wi-Fi Protected Setup. Blinker i ett minutt og slukkes deretter

**Belyst Linksys-logo** — Logoen blinker mens ruterens starter opp. Når logoen lyser fast hvit er ruterens slått på og fungerer riktig.

## Visning bakfra

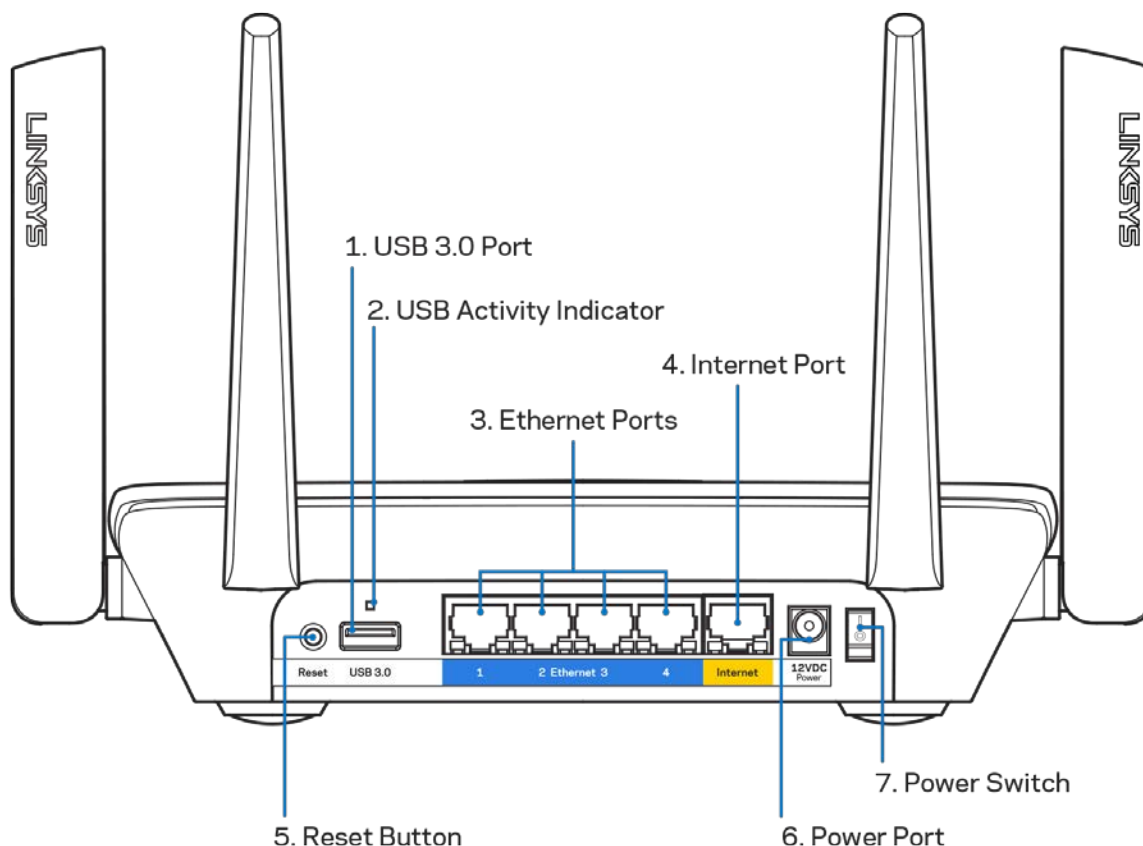

**USB 3.0-port (1)** - Koble til og del USB-stasjoner på nettverket eller på Internett.

**USB-aktivitetsindikator (2)** – Lys indikerer dataoverføring til/fra eksterne enheter.

**Ethernet-porter (3)** - Koble Ethernet-kabler til disse blå gigabit (10/100/1000)-portene, og til kabelbaserte enheter på nettverket ditt.

*Merk – For best mulig ytelse, kan du bruke CAT5e eller bedre rangerte kabler på Ethernet-portene.*

**Internet-port (4)** - Koble en Ethernet-kabel til denne gule Gigabit (10/100/1000)-porten, og til en Internett-bredbåndskabel/DSL eller et fibermodem.

*Merk – For best mulig ytelse, kan du bruke CAT5e eller bedre rangert kabel på Internet-porten.*

**Tilbakestillingsknapp (5)** - Trykk og hold inntil den belyste Linksys-logoen slukkes for å tilbakestille ruterens til fabrikkinnstillinger. Du kan også gjenopprette fabrikkinnstillingene med Linksys Smart Wi-Fi på Internett eller mobilappen.

**Strømport (6)** - Koble til strømadapteren som følger med.

**Strømbryter (7)** - Trykk på | (på) for å slå på ruterens.

## Sett fra siden

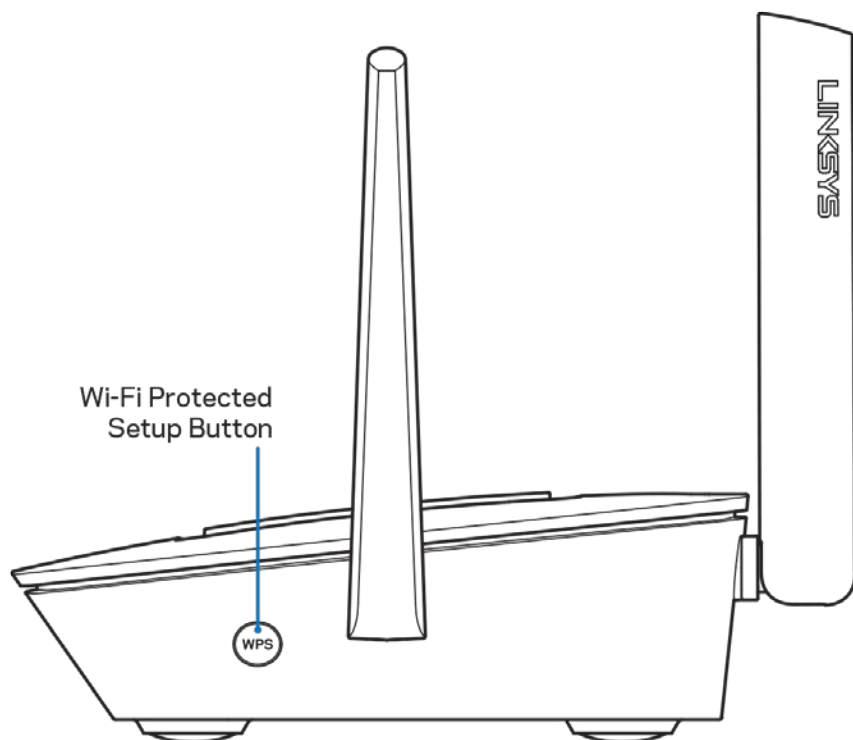

**Wi-Fi Protected Setup™-knapp** — Trykk for å koble til WPS-aktiverede nettverksenheter.

# Konfigurering: Grunnleggende

## Her finner du mer hjelp

I tillegg til denne brukerhåndboken, finner du hjelp på disse stedene:

- [Linksys.COM/support/EA8300](http://Linksys.COM/support/EA8300) (dokumentasjon, nedlastninger, vanlige spørsmål, teknisk støtte, chatting i sanntid, forum)
- Linksys Smart Wi-Fi-hjelp (koble til Linksys Smart Wi-Fi, klikk deretter Hjelp øverst på skjermen)

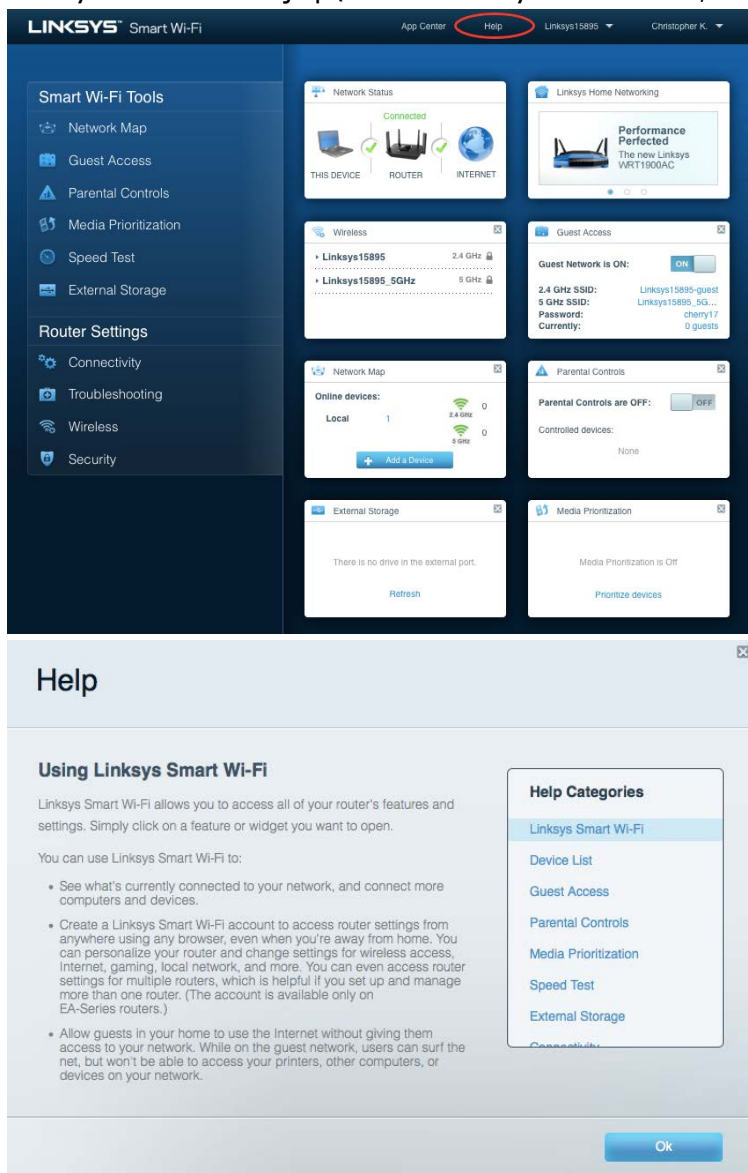

**Merk - Lisenser og merknader om tredjeparts programvare brukt i dette produktet er tilgjengelig på <http://support.linksys.com/en-us/license>. Ta kontakt med <http://support.linksys.com/en-us/gplcodecenter> for spørsmål eller forespørsler om GPL-kildekode.**

## Slik installerer du ruteren

1. For å fullføre oppsettet må du gå til <http://LinksysSmartWiFi.com> på en datamaskin.
2. Identifiser utstyret ditt.

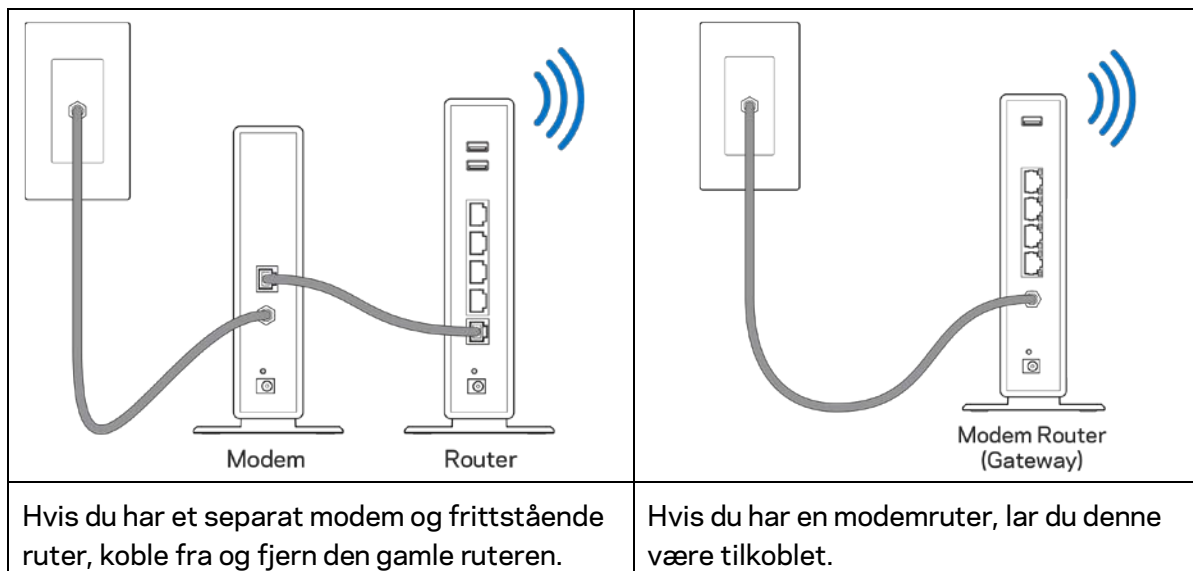

3. Posisjoner antennene rett opp, og koble ruterens til en strømkilde. Sørg for at strømbryteren står i | (på)-posisjonen.
4. Koble ruterens til modemmet eller modemruterens. Koble den ene enden av den inkluderte Internett-kabelen til den gule Internett-porten på den nye ruterens. Hvis du har et modem, koble den andre enden til Ethernet (LAN)-porten på modemmet. Hvis du har en modemruter kobler du til enhver tilgjengelig port.
5. Vent til den belyste Linksys-lampen øverst på ruterens slutter å blinke og lyser fast hvitt.
6. Koble til Wi-Fi-navnet som vises i Hurtigstartveiledning som fulgte med ruterens. (Du kan endre disse detaljene senere.) Hvis du trenger hjelp med å koble til nettverket, se enhetsdokumentasjonen på [linksys.COM/support/EA8300](http://linksys.COM/support/EA8300).

**Merk - Du vil ikke ha tilgang til Internett før ruterens er ferdig installert.**

7. Skriv inn <http://LinksysSmartWiFi.com> i en nettleser. Følg instruksjonene på skjermen for å fullføre konfigureringen av ruterens. Du kan også skrive inn 192.168.1.1 i en nettleser for å starte oppsettet.

Ved slutten av oppsettet følger du instruksjonene på skjermen for å konfigurere Linksys Smart Wi-Fi-kontoen din. Bruk Linksys Smart Wi-Fi til å konfigurere ruterens fra en datamaskin med Internett-tilkobling.

Behandle ruterens innstillinger:

- endre ruterens navn og passord
- konfigurere gjestetilgang
- konfigurere sperrefunksjon
- Koble enheter til Wi-Fi
- Teste Internett-tilkoblingshastigheten

**Merk** - Du får tilsendt en e-postbekreftelse som en del av kontooppsettet for Linksys Smart Wi-Fi. Fra hjemmenettverket, klikk på koblingen i e-posten for å assosiere ruterens med Linksys Smart Wi-Fi-kontoen.

**Tips** - Skriv ut neste side, skriv deretter ned ruter- og kontoinnstillinger i tabellen under som en referanse. Lagre notatene på et trygt sted.

2,4 GHz Wi-Fi-navn	
Wi-Fi-passord	
5 GHz <sub>1</sub> Wi-Fi-navn	
Wi-Fi-passord	
5 GHz <sub>2</sub> Wi-Fi-navn	
Wi-Fi-passord	
Ruterpassord	
2,4 GHz <sub>1</sub> gjeste-Wi-Fi-navn	
5 GHz <sub>1</sub> gjeste-Wi-Fi-navn	
Gjeste-Wi-Fi-passord (begge deler et passord)	
Brukernavn for Linksys Smart Wi-Fi	
Passord for Linksys Smart Wi-Fi	



# Slik bruker du Linksys Smart Wi-Fi

Du kan behandle ruteren fra hvor som helst ved å bruke Linksys Smart Wi-Fi, men du kan også gjøre det direkte fra hjemmenettverket. Linksys Smart Wi-Fi kan også være tilgjengelig for den mobile enheten. Se enhetens appbutikk for informasjon.

## Slik kobler du til Linksys Smart Wi-Fi

Slik kobler du til Linksys Smart Wi-Fi:

1. Åpne nettleseren på datamaskinen.
2. Gå til <http://LinksysSmartWiFi.com> og logg på kontoen din.

Linksys Smart Wi-Fi Sign In

If you have not yet created a Linksys Smart Wi-Fi account, click the "Create Account" button in the upper right corner of the page.

Give guests Internet access

Use your Linksys Smart Wi-Fi account to access your home network from anywhere, at any time, even from your mobile device. Easily connect new devices, set parental controls, get access to Smart Wi-Fi mobile Apps, and more.

For more information [click here](#)

English (United States)

For local access, [click here](#).

Hvis du ikke kan huske passordet ditt, klikk på *Forgot your password?* (Har du glemt passordet ditt?) og følg anvisningene på skjermen for å gjenopprette det.

## Nettverkskart

Lar deg vise og administrere alle nettverksenhetene som er koblet til ruterens. Du kan vise enheter på hovednettverket og gjestenettverket, eller vise informasjon om hver av enhetene.



## Gjestetilgang

Lar deg sette opp og overvåke et nettverk for gjester som vil ha tilgang til Wi-Fi uten å avsløre personlig informasjon.

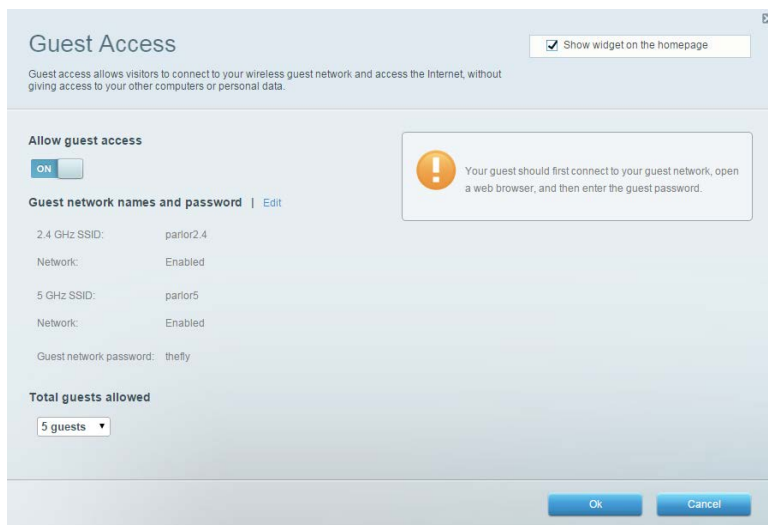

## Foreldrekontroll

Lar deg blokkere webområder og angi tider for Internett-tilgang.

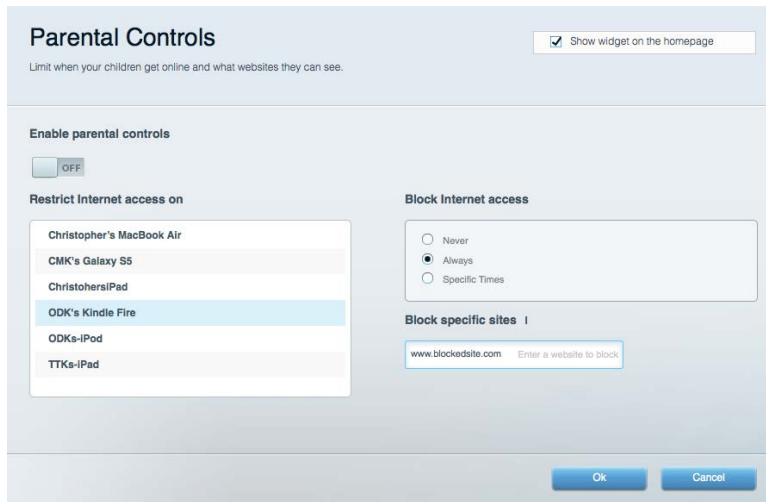

## Medieprioritering

Lar deg stille inn hvilke enheter og applikasjoner som har første prioritering for nettverkstrafikken.

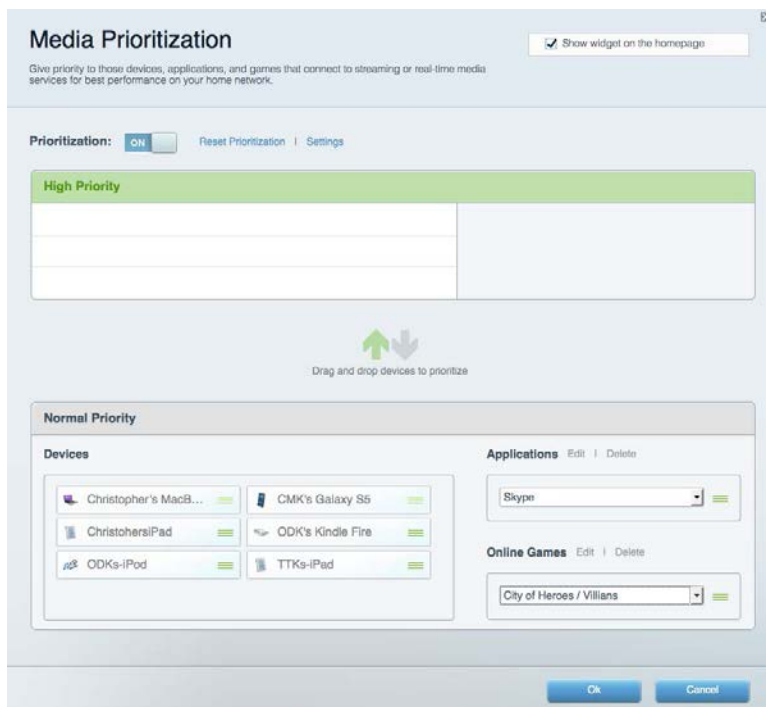

# Hastighetstest

Lar deg teste nettverkets Internett-tilkoblingshastighet.



# Ekstern lagringsplass

Lar deg få tilgang til en USB-stasjon som er tilkoblet (ikke inkludert) og konfigurere fildeling, en medieserver og FTP-tilgang.



## Tilkobling

Lar deg se og endre grunnleggende og avanserte nettverksinnstillinger.

The screenshot shows the 'Connectivity' settings page. At the top, there are tabs for 'Basic', 'Internet Settings', 'Local Network', 'Advanced Routing', 'VLAN', and 'Administration'. The 'Basic' tab is selected. The page is divided into several sections:

- Network Name and Password | Edit**: Fields for 2.4 GHz network name (arachnid), Network password (peterparker), 5 GHz<sub>1</sub> + 5 GHz<sub>2</sub> network name (arachnid\_5GHz), and Network password (peterparker).
- Router Password | Edit**: Field for Router password (masked with asterisks).
- Router Firmware Update**: A checkbox for 'Automatic' (checked) with '(Current Version: 1.1.5.164615)' and a 'Check for Updates' button.
- Time Zone**: A dropdown menu set to '(GMT-05:00) Eastern Time (USA & Canada)' and a checked checkbox for 'Automatically adjust for Daylight Savings Time'.
- Activity Lights**: An 'ON' button and a text box stating 'Enable/disable activity lights. Power light will remain on.'

At the bottom, there are 'Ok', 'Cancel', and 'Apply' buttons.

## Feilsøking

Lar deg diagnostisere problemer med ruterer og kontrollere status for nettverket.

The screenshot shows the 'Troubleshooting' settings page. At the top, there are tabs for 'Status', 'Diagnostics', and 'Logs'. The 'Diagnostics' tab is selected. The page is divided into several sections:

- Ping IPv4**: Fields for 'IP or host name' and 'Number to ping' (set to 5), with a 'Start to Ping' button.
- Trace route**: Field for 'IP or host name' and a 'Start to Traceroute' button.
- Reboot**: A link 'Reboot the router'.
- Router configuration**: 'Backup' and 'Restore' buttons.
- Router Firmware**: A 'Restore previous firmware' button.
- Internet Address:** Fields for IPv4 (10.0.0.253) and IPv6 (2801:0540::000:0019:0000:0000:0000:314e), each with a 'Release and Renew' link.
- Factory reset**: A link 'Reset to factory default settings'.

At the bottom, there is an 'Ok' button.

## Trådløst

Lar deg se og endre ruterens trådløse nettverk. Du kan endre nettverksnavnene, sikkerhetsmodus, passord, MAC-filtrering og koble til enheter ved hjelp av Wi-Fi Protected Setup.

Wireless

View and change router settings

Wireless | MAC Filtering | Wi-Fi Protected Setup

Smart Connect:  5 GHz band steering (5 GHz<sub>1</sub> + 5 GHz<sub>2</sub>)  Off (Individual networks) What is Smart Connect band steering?

Network name: arachnid 2.4 GHz Network:  ON

Password: peterparker Broadcast SSID: Yes Channel: Auto

Security mode: WPA2/WPA Mixed Pt Network mode: Mixed Channel width: Auto

Network name: arachnid\_5GHz 5 GHz<sub>1</sub> + 5 GHz<sub>2</sub> Network:  ON

Password: peterparker Broadcast SSID: Yes Channel: Auto

Security mode: WPA2/WPA Mixed Pt Network mode: Auto Channel width: Auto

Ok Cancel Apply

## Sikkerhet

Lar deg se og endre ruterens trådløse sikkerhet. Du kan konfigurere brannmur og VPN-innstillinger og angi egendefinerte innstillinger for applikasjoner og spill.

Security

View and change router settings

Firewall | DMZ | Apps and Gaming

**Firewall**

IPv4 SPI firewall protection  Enabled

IPv6 SPI firewall protection  Enabled

**Internet filters**

Filter anonymous Internet requests

Filter multicast

Filter Internet NAT redirection

Filter ident (Port 113)

**VPN Passthrough**

IPSec Passthrough  Enabled

PPTP Passthrough  Enabled

L2TP Passthrough  Enabled

**IPv6 Port Services**

Description	Protocol	IPv6 Address	Allow	Enabled
-------------	----------	--------------	-------	---------

Add IPv6 Firewall Setting

Ok Cancel Apply

# Feilsøking

Du kan få mer hjelp døgnet rundt fra vår prisbelønte kundestøtte på [linksys.COM/support/EA8300](https://linksys.COM/support/EA8300).

## Ruteren din ble ikke riktig installert

Hvis Linksys Smart Wi-Fi ikke fullførte oppsettet, kan du prøve følgende:

- Trykk og hold Tilbakestill-knappen på ruteren med en binders eller nål inntil den belyste Linksys-logoen slukkes og de blå MU-MIMO-indikatorene begynner å blinke (omtrent 10 sekunder). Installer ruteren igjen.

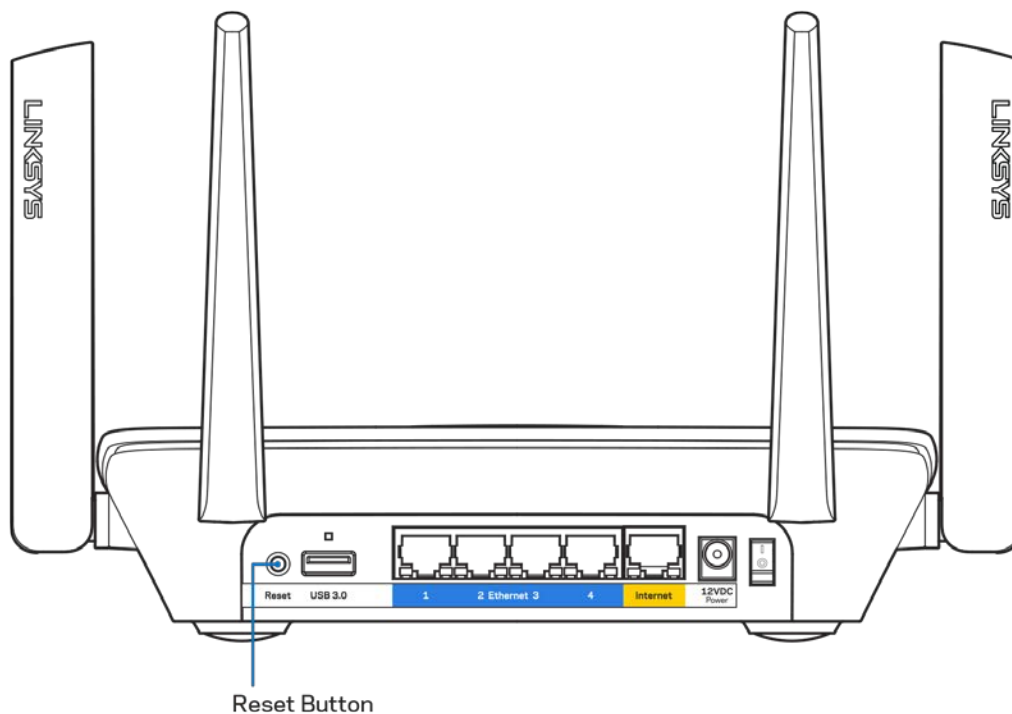

- Du kan midlertidig deaktivere datamaskinens brannmur (se instruksjonene til sikkerhetsprogramvaren for hjelp). Installer ruteren igjen.
- Hvis du har en annen datamaskin, bruk den datamaskinen til å installere ruteren på nytt.

## Melding om at *Internett-kabelen ikke er koblet til*

Hvis du får meldingen "Internett-kabelen er ikke koblet til" når du prøver å konfigurere ruterer, følg disse feilsøkingstipsene.

- Sørg for at en Ethernet- eller Internet-kabel (eller en kabel som den som fulgte med ruterer din) er riktig koblet til den gule Internett-porten på baksiden av ruterer og den passende porten på modemmet ditt. Denne porten på modemmet er vanligvis merket Ethernet.

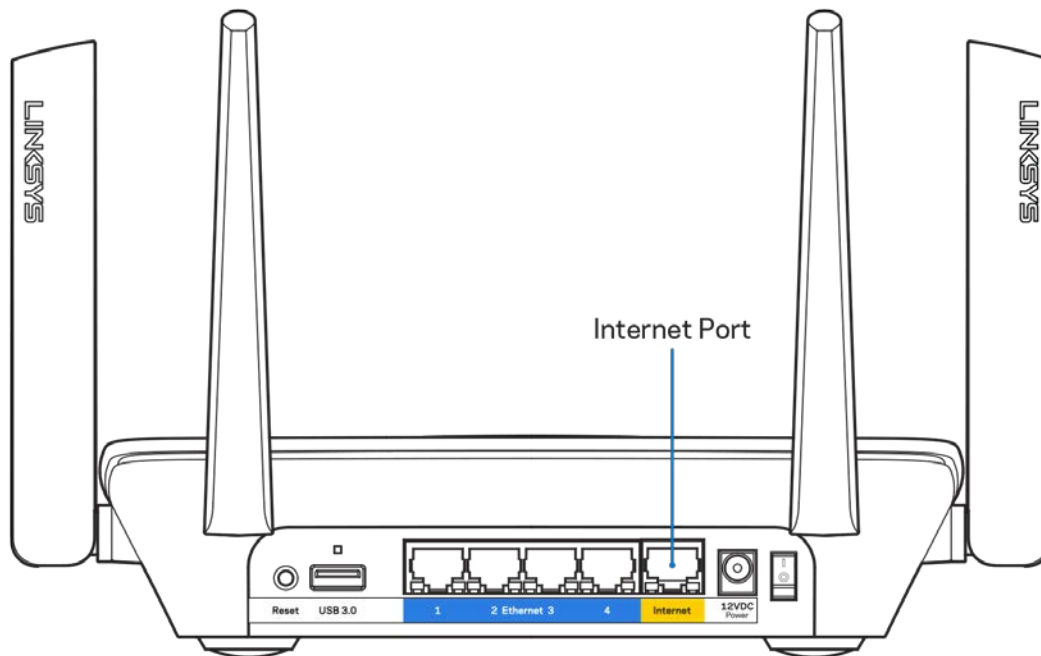

- Sørg for at modemmet er koblet til strøm og er skrudd på. Hvis det har en strømbryter, sjekker du at denne er satt i posisjonen ON eller I (i motsetning til O).

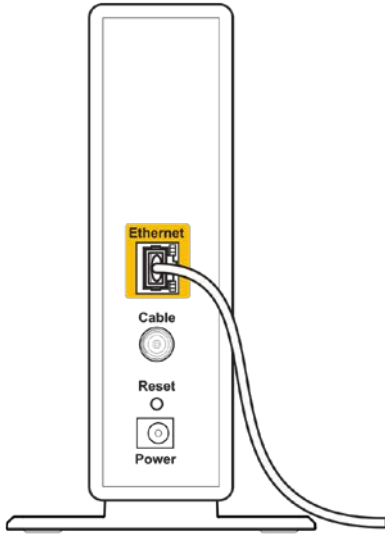
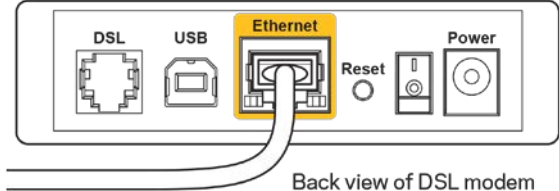

 <p>Back view of cable modem</p>	 <p>Back view of DSL modem</p>
<p>Hvis Internett-tjenesten er kabel, kontrollerer du at kabelmodemets CABLE-port er koblet til den koaksiale kabelen som du får fra Internett-leverandøren.</p>	<p>Hvis Internett-tjenesten er DSL, sørg for at DSL-telefonlinjen er koblet til modemets DSL-port.</p>

- Hvis datamaskinen tidligere ble koblet til modemmet med en USB-kabel, kobler du fra USB-kabelen.
- Installer ruterer igjen.

## Melding om *manglende tilgang til ruterer*

For tilgang til ruterne, må du være koblet til ditt eget nettverk. Hvis du har trådløs Internett-tilgang, kan problemet være at du har koblet til feil trådløst nettverk.

Gjør følgende for å fikse problemet på Windows-datamaskiner\*:

1. Klikk på det trådløse ikonet i systemkurven. En liste over tilgjengelige nettverk vises.

2. Klikk på ditt eget nettverksnavn. Klikk på Koble til. I eksemplet under, ble datamaskinen koblet til et annet nettverk som het wraith\_5GHz. Navnet på det trådløse nettverket til Linksys EA8300-ruteren, Damaged\_Beez2.4 i dette eksemplet, vises valgt.



3. Hvis du blir bedt om å angi en nettverkssikkerhetsnøkkel, skriv inn passordet (sikkerhetsnøkkel) i feltet *Nettverksnøkkel*. Klikk på **OK**.
4. Datamaskinen vil koble til nettverket og du kan få tilgang til ruteren.

*\*Avhengig av din versjon av Windows, kan det være noen forskjeller i setningsformuleringen eller ikonene i disse trinnene.*

Gjør følgende for å fikse problemet på Mac-datamaskiner:

1. I menylinjen øverst på skjermen, klikk på Wi-Fi ikonet. En liste over trådløse nettverk vises.
2. I eksemplet under, ble datamaskinen koblet til et annet nettverk som het wraith\_5GHz. Navnet på det trådløse nettverket til Linksys EA8300-ruteren, Damaged\_Beez2.4 i dette eksemplet, vises valgt.



3. Klikk på det trådløse nettverksnavnet til Linksys EA8300-ruteren (Damaged\_Beez2.4 i eksemplet).
4. Skriv inn passordet (sikkerhetsnøkkel) til det trådløse nettverk i *Passord*-feltet. Klikk på **OK**.

## Etter oppsett

### Internett virker å være utilgjengelig

Hvis Internett har problemer med å kommunisere med ruteren, kan problemet vises som en melding "Cannot find [Internet address]" (Kan ikke finne [Internett-adresse]) i nettleseren. Hvis du vet at Internett-adressen er korrekt, og hvis du har prøvd flere gyldige Internett-adresser med samme resultat, kan meldingen bety at det er et problem med Internett-leverandøren eller modemmet som kommuniserer med ruteren. Prøv følgende:

- Sørg for at nettverks- og strømkabler er sikkert koblet til.
- Sørg for at strømuttaket som ruteren er koblet til har strøm.
- Start ruteren på nytt.
- Kontakt Internett-leverandøren og spør om forstyrrelser i området ditt.

Den vanligste feilsøkingemetoden for ruteren er å slå den av, deretter på igjen. Ruteren kan da laste inn igjen egendefinerte innstillinger, og andre enheter (som modemmet) kan gjenoppdage ruteren og kommunisere med den. Denne prosessen kalles omstart.

Gjør følgende for å starte ruteren på nytt med strømledningen:

1. Koble strømledningen fra ruteren og modemmet.
2. Vent 10 sekunder og koble strømledningen til modemmet. Sørg for at den har strøm.
3. Vent til modemets onlineindikator har sluttet å blinke (omtrent to minutter). Koble strømledningen til ruteren igjen.
4. Vent til den belyste Linksys-logoen tennes. Vent to minutter før du prøver å koble til Internett fra en datamaskin.

Gjør følgende for å starte ruteren på nytt med Linksys Smart Wi-Fi:

1. Logg på Linksys Smart Wi-Fi. (Se "Slik kobler du til Linksys Smart Wi-Fi" på side [11](#).)
2. Under *Router Settings* (Ruterinnstillinger), klikk på *Troubleshooting* (Feilsøking).
3. Klikk på fanen *Diagnostics* (Diagnose).
4. Under *Reboot* (Start på nytt), klikk på *Reboot* (Start på nytt).



5. Klikk **Yes** (Ja). Ruteren vil starte på nytt. Mens ruteren starter på nytt, vil alle tilkoblede enheter miste deres Internett-tilkobling, og vil automatisk koble til på nytt når ruteren er klar igjen.

## Linksys Smart Wi-Fi åpner ikke i nettleseren.

Siste versjon av Google Chrome™, Firefox®, Safari® (for Mac® og iPad®), Microsoft Edge og Internet Explorer® versjon 8 og nyere fungerer med Linksys Smart Wi-Fi.

# Spesifikasjoner

## Linksys EA8300

Modellnavn	Max-Stream AC2200 MU-MIMO Tri-Band Router
Modellnummer	EA8300
Svitsjport hastighet	10/100/1000 Mbps (Gigabit Ethernet)
Radiofrekvens	2,4 GHz og 5 GHz (x2)
Antall antenner	4 eksterne, regulerbare antenner (fastmontert)
Porter	USB 3.0, Ethernet (1-4), Internet, Strøm
Knapper	Wi-Fi Protected Setup, Strøm, Tilbakestill
Lys	<b>Topp panel:</b> Belyst Linksys-logo, Wi-Fi Protected Setup, Internett-tilkobling, tilkobling av nettverkskabel til Internett-port <b>Baksidepanel:</b> USB, Ethernet (1-4), Internet
UPnP	Støttes
Sikkerhetsfunksjoner	WEP, WPA2, RADIUS
Sikkerhetsnøkkelbiter	Opptil 128-biters kryptering
Støtte for fillagringsystem	FAT, NTFS og HFS+
Støtte for nettleser	Siste versjoner av Google Chrome™, Firefox®, Safari® (for Mac® og iPad®), Microsoft Edge og Internet Explorer® versjon 8 og nyere

## Omgivelser

Mål	213,7mm x 161,8mm x 54,8mm (uten antenner)
Enhetens vekt	608 g
Strøm	12 V, 2A
Sertifiseringer	FCC, IC, CE, Wi-Fi (a/b/g/n/ac)
Driftstemperatur	0-40 °C (32-104 °F)
Oppbevaringstemperatur	-20-60 °C (-4-140 °F)
Luftfuktighet for drift	10 til 80 %, relativ fuktighet, ikke-kondenserende
Luftfuktighet for oppbevaring	5-90 % ikke-kondenserende

Spesifikasjonene kan endres uten varsel.

Merknader:

For informasjon om bestemmelser, garanti og sikkerhet, se CD-platen som fulgte med ruterens eller gå til [Linksys.com/support/EA8300](http://Linksys.com/support/EA8300).

Maksimal ytelse avledet fra IEEE Standard 802.11-spesifikasjoner. Den faktiske ytelsen kan variere. Dette kan gjelde lavere kapasitet i det trådløse nettverket, datahastighet, rekkevidde og dekning. Ytelse er avhengig av mange faktorer, forhold og variabler, blant annet avstand fra tilgangspunkt, nettverkstrafikk, byggematerialer og konstruksjon, operativsystem, blandingen av trådløse produkter som brukes, interferens og andre ugunstige forhold.

BELKIN, LINKSYS og mange produktnavn og logoer er varemerker som tilhører Belkin-selskapsgruppen. Tredjeparts varemerker som nevnes her, tilhører de respektive eierne. Lisenser og merknader om tredjeparts programvare brukt i dette produktet er tilgjengelig her: <http://support.linksys.com/en-us/license>. Ta kontakt med <http://support.linksys.com/en-us/gplcodecenter> for spørsmål eller forespørsler om GPL-kildekode.

© 2017 Belkin International, Inc. og/eller tilknyttede selskaper. Med enerett.

**LINKSYS®**

Instrukcja obsługi

**MAX-STREAM™  
AC2200 MU-MIMO  
ROUTER TRÓJPASMOWY**

Model EA8300

# Spis treści

Opis produktu.....	3
Widok z góry .....	3
Wskaźnik stanu systemu.....	4
Widok z tyłu .....	5
Widok z boku.....	6
Przygotowanie urządzenia do pracy: Podstawy .....	7
Gdzie znaleźć pomoc.....	7
Instalowanie routera.....	8
Korzystanie z interfejsu Linksys Smart Wi-Fi.....	11
Uzyskiwanie dostępu do interfejsu Linksys Smart Wi-Fi .....	11
Mapa sieci.....	12
Dostęp w trybie gościa.....	12
Kontrola rodzicielska.....	13
Priorytetyzacja multimediiów.....	13
Test szybkości.....	14
Zewnętrzna pamięć masowa.....	14
Połączenia .....	15
Rozwiązywanie problemów .....	15
Łączność bezprzewodowa .....	16
Zabezpieczenie .....	16
Rozwiązywanie problemów .....	17
Router nie został prawidłowo skonfigurowany.....	17
Komunikat <i>Your Internet cable is not plugged in</i> (Kabel internetowy nie jest podłączony) .....	18
Komunikat o braku dostępu do routera ( <i>Cannot access your router</i> ).....	19
Po konfiguracji.....	21
Internet jest niedostępny.....	21
Interfejs Linksys Smart Wi-Fi nie otwiera się w przeglądarce.....	22
Parametry techniczne .....	23
Linksys EA8300 .....	23
Parametry fizyczne i środowiskowe .....	23



# Opis produktu

## Widok z góry

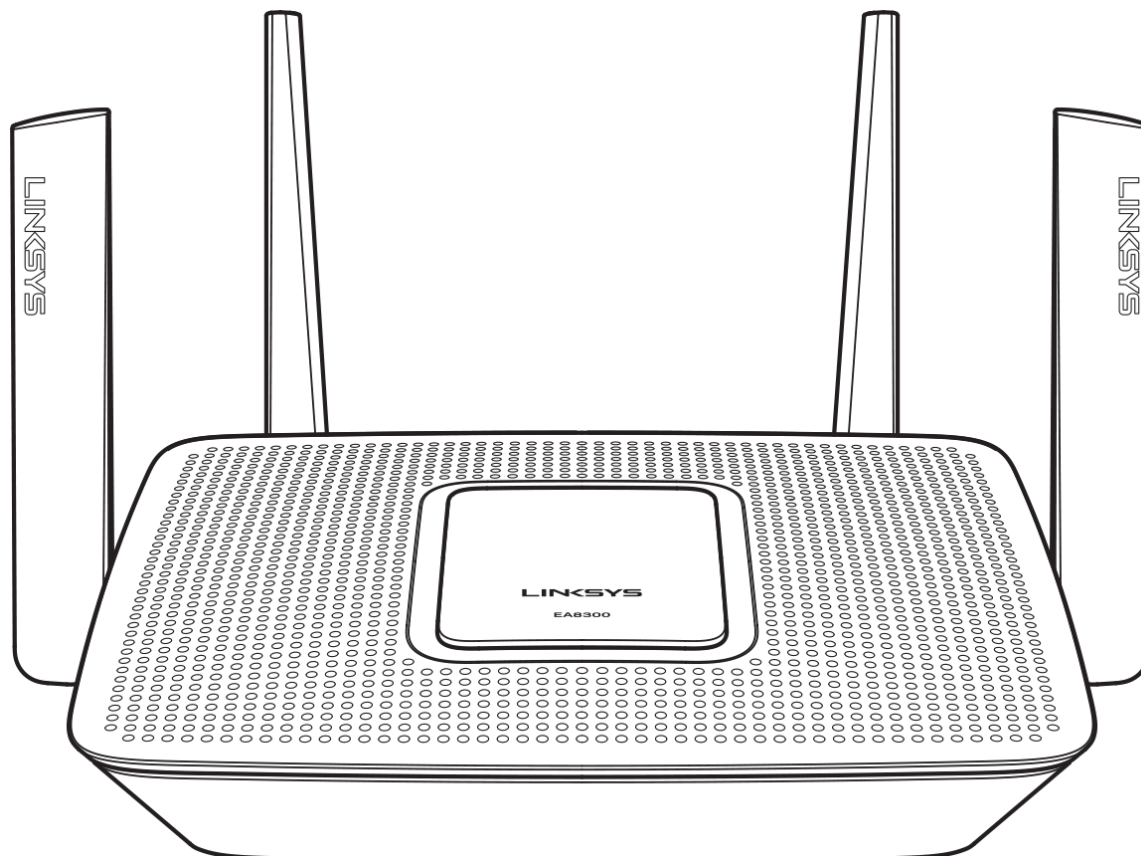

## Wskaźnik stanu systemu

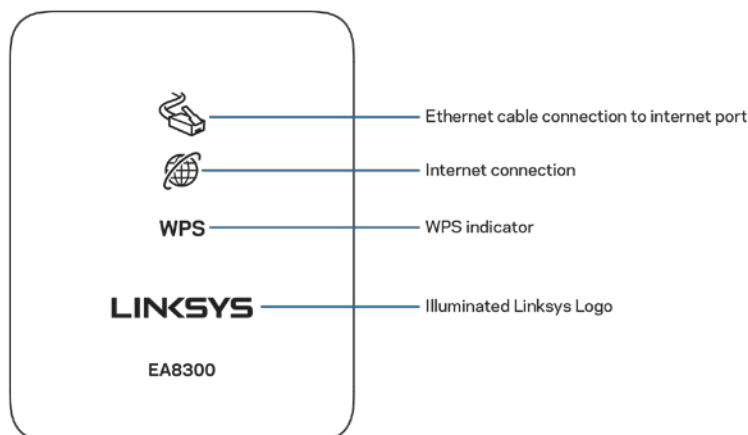

**Podłączenie kabla Ethernet do gniazda Internet** — gdy ta kontrolka się świeci (na pomarańczowo), oznacza to problem z kablem sieciowym podłączonym do gniazda Internet (WAN).

**Połączenie internetowe** — gdy ta kontrolka się świeci (na pomarańczowo), oznacza to, że router nie ma dostępu do Internetu.

**Wskaźnik WPS (Wi-Fi Protected Setup™)** — kontrolka WPS ma cztery stany:

<b>Nie świeci</b>	Brak aktywności związanej z funkcją Wi-Fi Protected Setup
<b>Miga na biało</b>	Trwa konfiguracja funkcji Wi-Fi Protected Setup (WPS)
<b>Świeci na biało światłem ciągłym</b>	Konfiguracja funkcji Wi-Fi Protected Setup powiodła się; kontrolka świeci się przez pięć sekund
<b>Miga na pomarańczowo</b>	Błąd funkcji Wi-Fi Protected Setup; miga przez jedną minutę, a potem się wyłącza

**Podświetlone logo Linksys** — logo miga, gdy router się uruchamia. Gdy logo świeci na biało światłem ciągłym, oznacza to, że router jest włączony i działa prawidłowo.

## Widok z tyłu

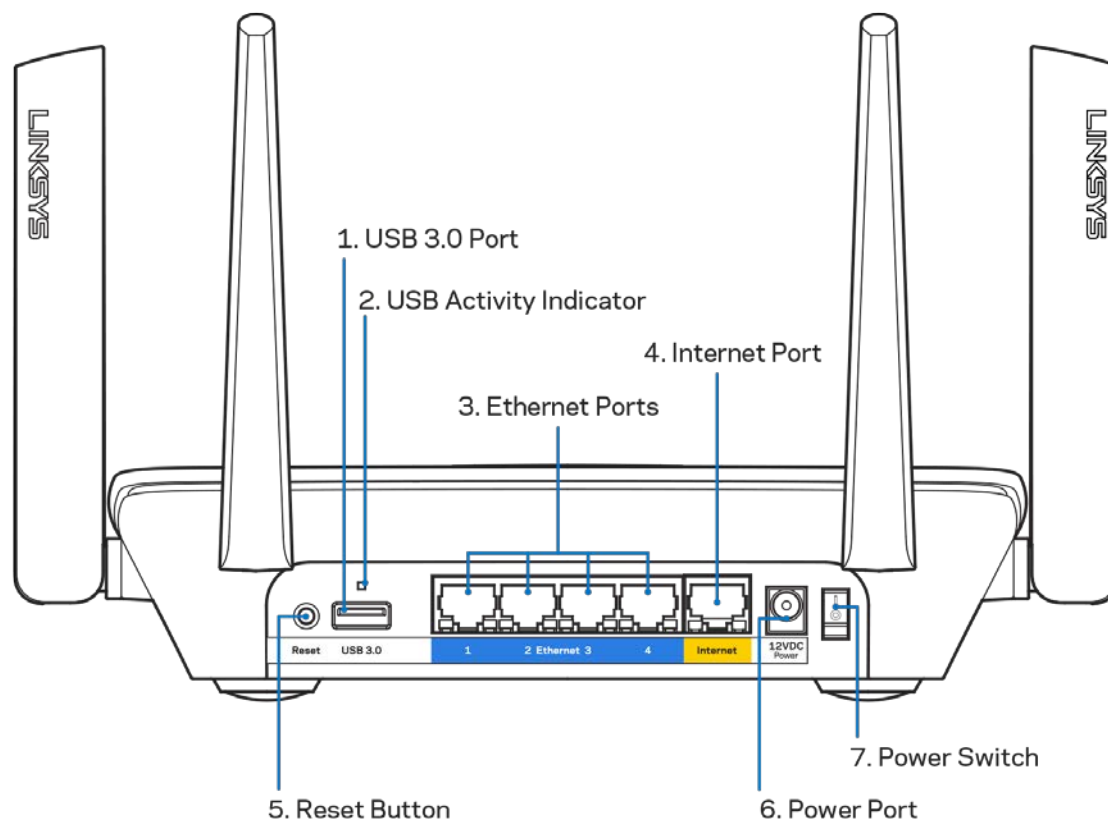

**Gniazdo USB 3.0 (1)** — Tutaj można podłączyć napędy USB w celu udostępnienia ich w sieci domowej lub w Internecie.

**Kontrolka aktywności portu USB (2)** — światło oznacza przesyłanie danych do lub z urządzeń zewnętrznych.

**Gniazda Ethernet (3)** — do tych niebieskich gniazd gigabitowych (10/100/1000) należy podłączyć kable Ethernet prowadzące do urządzeń komunikujących się z siecią drogą przewodową.

*Uwaga — W celu uzyskania najlepszej wydajności należy stosować kable z oznaczeniem CAT5e lub wyższym.*

**Gniazdo Internet (4)** — do tego żółtego gniazda gigabitowego (10/100/1000) należy podłączyć kabel Ethernet prowadzący do szerokopasmowego modemu kablowego, DSL lub światłowodowego.

*Uwaga — W celu uzyskania najlepszej wydajności do gniazda Internet należy podłączyć kabel z oznaczeniem CAT5e lub wyższym.*

**Przycisk resetowania (5)** — naciśnięcie i przytrzymanie tego przycisku (aż podświetlane logo Linksys zgaśnie) powoduje przywrócenie fabrycznych ustawień routera. Ustawienia fabryczne można także przywrócić za pomocą interfejsu Linksys Smart Wi-Fi lub aplikacji mobilnej.

**Gniazdo zasilania (6)** — tutaj należy podłączyć znajdujący się w zestawie zasilacz.

**Wyłącznik zasilania (7)** — naciśnięcie | (wł.) powoduje włączenie routera.

## Widok z boku

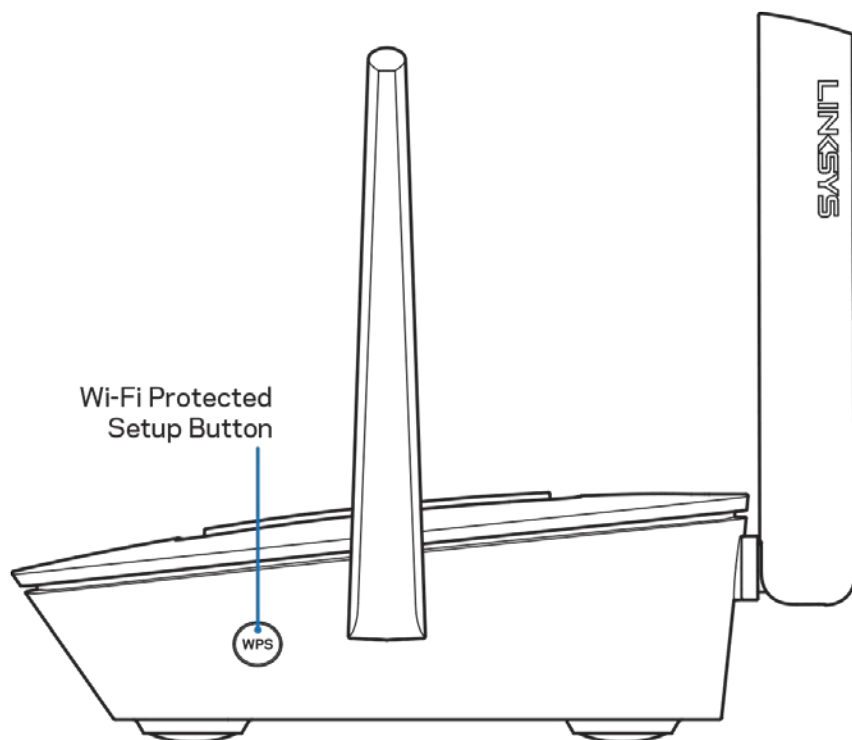

**Przycisk Wi-Fi Protected Setup™** — naciśnięcie tego przycisku umożliwia podłączenie urządzeń sieciowych obsługujących funkcję WPS.

# Przygotowanie urządzenia do pracy: Podstawy

## Gdzie znaleźć pomoc

Oprócz niniejszej instrukcji obsługi pomoc można także uzyskać w następujących miejscach:

- [Linksys.com/support/EA8300](http://Linksys.com/support/EA8300) (dokumentacja, materiały do pobrania, pytania i odpowiedzi, pomoc techniczna, chat na żywo, fora)
- Pomoc Linksys Smart Wi-Fi (nawiąż połączenie z interfejsem Linksys Smart Wi-Fi, następnie kliknij Pomoc w górnej części ekranu)

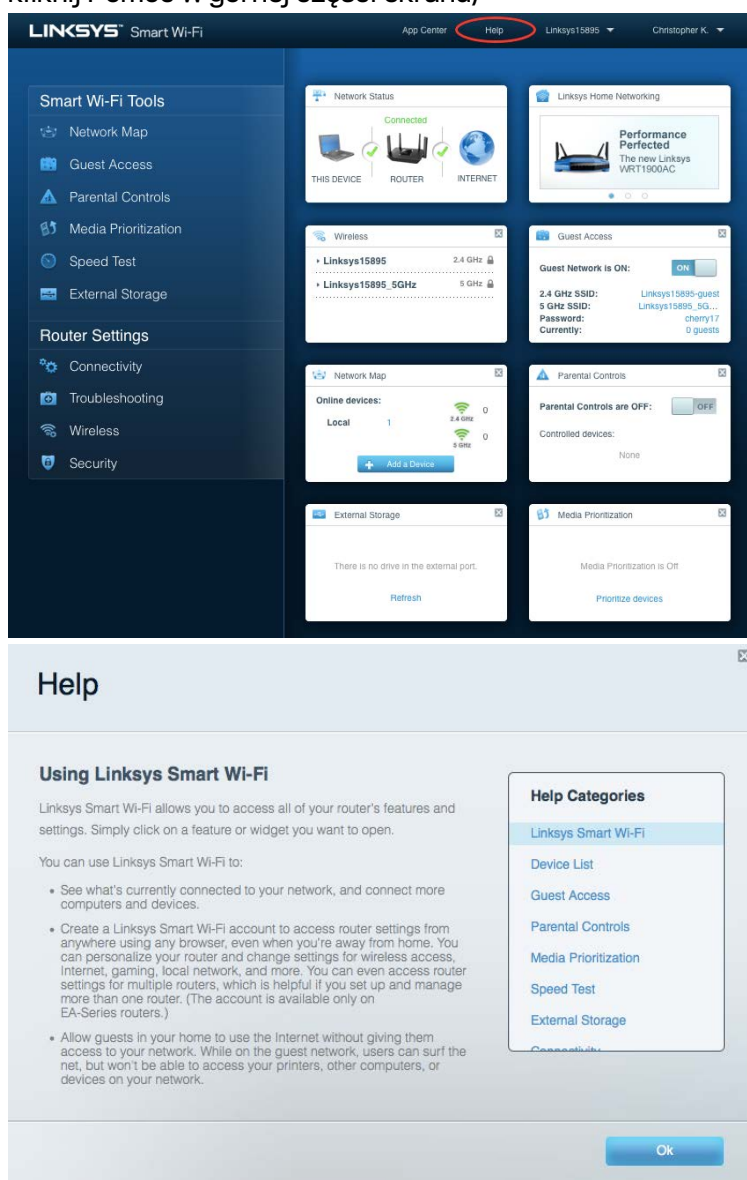

The screenshot shows the Linksys Smart Wi-Fi app interface. At the top, the 'Help' menu item is circled in red. Below the main dashboard, a 'Help' modal window is open, displaying the following content:

### Help

**Using Linksys Smart Wi-Fi**

Linksys Smart Wi-Fi allows you to access all of your router's features and settings. Simply click on a feature or widget you want to open.

You can use Linksys Smart Wi-Fi to:

- See what's currently connected to your network, and connect more computers and devices.
- Create a Linksys Smart Wi-Fi account to access router settings from anywhere using any browser, even when you're away from home. You can personalize your router and change settings for wireless access, Internet, gaming, local network, and more. You can even access router settings for multiple routers, which is helpful if you set up and manage more than one router. (The account is available only on EA-Series routers.)
- Allow guests in your home to use the Internet without giving them access to your network. While on the guest network, users can surf the net, but won't be able to access your printers, other computers, or devices on your network.

**Help Categories**

- Linksys Smart Wi-Fi
- Device List
- Guest Access
- Parental Controls
- Media Prioritization
- Speed Test
- External Storage
- Connectivity

Ok

**Uwaga** — Licencje i powiadomienia dot. oprogramowania innych dostawców stosowanego w tym produkcie są dostępne na stronie <http://support.linksys.com/en-us/license>. Pytania dotyczące kodu open source lub licencji GPL: <http://support.linksys.com/en-us/gplcodecenter>.

## Instalowanie routera

1. Przeprowadzenie konfiguracji wymagać będzie komputera w celu otwarcia strony <http://LinksysSmartWiFi.com> w przeglądarce internetowej.
2. Zidentyfikuj sprzęt.

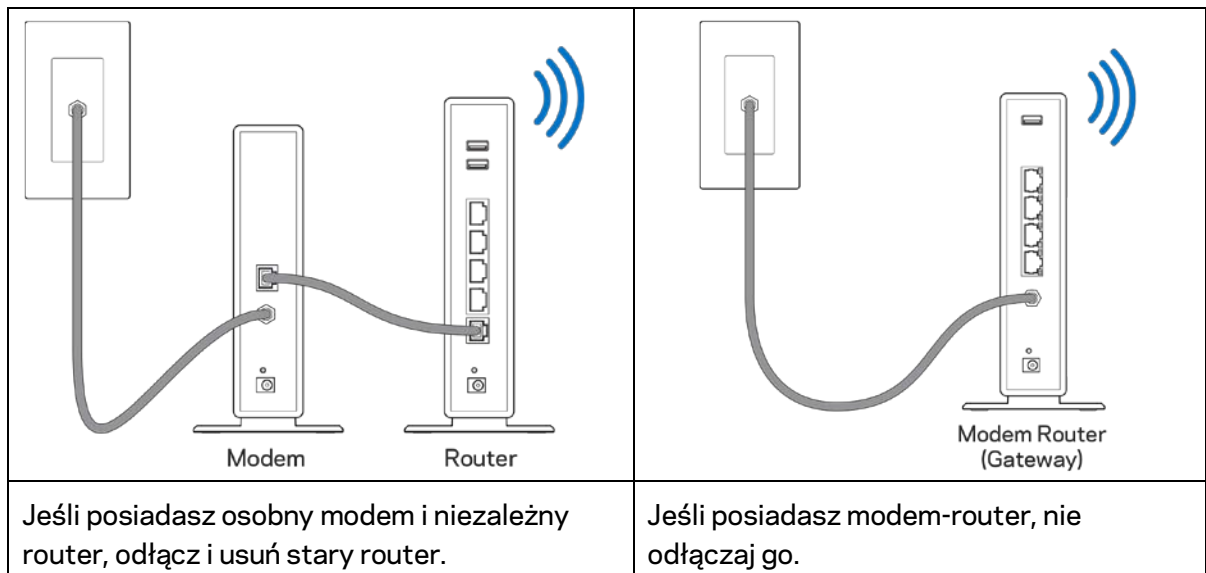

3. Ustaw anteny pionowo i podłącz router do źródła zasilania. Upewnij się, że przycisk zasilania znajduje się w pozycji | (wł.).
4. Podłącz router do modemu lub modemu-routera. Podłącz jeden koniec załączonego kabla internetowego do żółtego gniazda Internet nowego routera. Jeśli posiadasz modem, podłącz drugi koniec do gniazda Ethernet (LAN) na modemie. Jeśli posiadasz modem-router, podłącz go do dowolnego dostępnego gniazda.
5. Poczekaj, aż podświetlane logo Linksys w górnej części routera przestanie migać i zacznie świecić białym światłem ciągłym.
6. Nawiąż połączenie z siecią Wi-Fi o nazwie takiej, jak podano w Skróconej instrukcji dołączonej do routera. (To ustawienie można zmienić później). Jeśli potrzebujesz pomocy przy nawiązywaniu połączenia z siecią, zapoznaj się z dokumentacją urządzenia dostępną pod adresem [linksys.com/support/EA8300](http://linksys.com/support/EA8300).

**Uwaga** — dostęp do Internetu będzie możliwy dopiero po ukończeniu konfigurowania routera.

7. W przeglądarce internetowej otwórz witrynę <http://LinksysSmartWiFi.com>. Aby wykonać instalację, postępuj zgodnie z instrukcją na ekranie. Aby rozpocząć konfigurowanie, możesz także wpisać 192.168.1.1 w przeglądarce.

Na zakończenie konfiguracji skonfiguruj konto Linksys Smart Wi-Fi zgodnie z wyświetloną instrukcją. Interfejs Linksys Smart Wi-Fi pozwala konfigurować router z dowolnego komputera połączanego z Internetem.

Zarządzanie ustawieniami routera:

- zmiana nazwy i hasła routera
- konfiguracja dostępu dla gości
- konfiguracja kontroli rodzicielskiej
- podłączanie urządzeń do sieci Wi-Fi
- testowanie prędkości połączenia internetowego

**Uwaga** — *Na pewnym etapie konfigurowania konta Linksys Smart Wi-Fi do użytkownika wysyłany jest e-mail weryfikacyjny. W sieci domowej kliknij łącze w tej wiadomości e-mail w celu skojarzenia routera z kontem Linksys Smart Wi-Fi.*

**Wskazówka** — *Wydrukuj następną stronę, a następnie w celach referencyjnych odnotuj ustawienia routera i konta w poniższej tabelce. Zanotowane informacje przechowuj w miejscu, w którym łatwo jest je znaleźć.*

Nazwa sieci Wi-Fi 2,4 GHz	
Hasło sieci Wi-Fi	
Nazwa sieci Wi-Fi 5 GHz <sub>1</sub>	
Hasło sieci Wi-Fi	
Nazwa sieci Wi-Fi 5 GHz <sub>2</sub>	
Hasło sieci Wi-Fi	
Hasło routera	
Nazwa gościnniej sieci Wi-Fi 2,4 GHz	
Nazwa gościnniej sieci Wi-Fi 5 GHz	
Hasło gościnniej sieci Wi-Fi (obie mają takie samo hasło)	
Nazwa użytkownika konta Linksys Smart Wi-Fi	
Hasło konta Linksys Smart Wi-Fi	



# Korzystanie z interfejsu Linksys Smart Wi-Fi

Routerem można zarządzać z dowolnego miejsca na świecie za pośrednictwem usługi Linksys Smart Wi-Fi, ale jest to także możliwe bezpośrednio z poziomu sieci domowej. Usługa Linksys Smart Wi-Fi może być także dostępna z poziomu urządzenia przenośnego. W celu uzyskania informacji na ten temat zajrzyj do sklepu z aplikacjami w posiadanym urządzeniu.

## Uzyskiwanie dostępu do interfejsu Linksys Smart Wi-Fi

Aby uzyskać dostęp do interfejsu Linksys Smart Wi-Fi:

1. Uruchom przeglądarkę w komputerze.
2. Otwórz stronę <http://LinksysSmartWiFi.com> i zaloguj się do swojego konta.

Linksys Smart Wi-Fi Sign In

If you have not yet created a Linksys Smart Wi-Fi account, click the 'Create Account' button in the upper right corner of the page.

Give guests Internet access

Use your Linksys Smart Wi-Fi account to access your home network from anywhere, at any time, even from your mobile device. Easily connect new devices, set parental controls, get access to Smart Wi-Fi mobile Apps, and more.

For more information [click here](#)

English (United States)

For local access, [click here](#).

Jeśli nie pamiętasz hasła, kliknij *Forgot your password?* (Nie pamiętasz hasła?) i postępuj zgodnie z wyświetlanymi instrukcjami w celu jego odzyskania.

## Mapa sieci

Pozwala wyświetlić wszystkie urządzenia sieciowe podłączone do routera i zarządzać nimi. Możliwe jest wyświetlenie urządzeń podłączonych do sieci głównej oraz do sieci gościnnej, a także wyświetlenie informacji na ich temat.



## Dostęp w trybie gościa

Umożliwia takie skonfigurowanie i monitorowanie sieci, które umożliwia gościom dostęp do sieci Wi-Fi bez ujawniania danych osobowych.

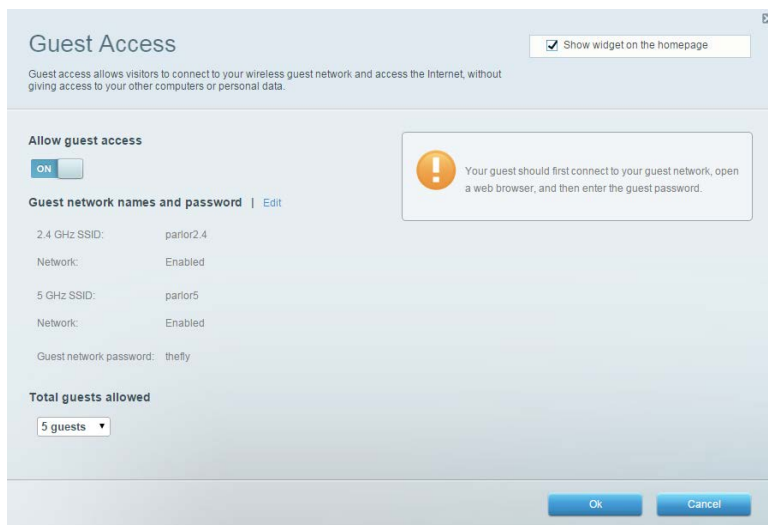

## Kontrola rodzicielska

Umożliwia zablokowanie stron internetowych i ustawienie godzin dostępu do Internetu.

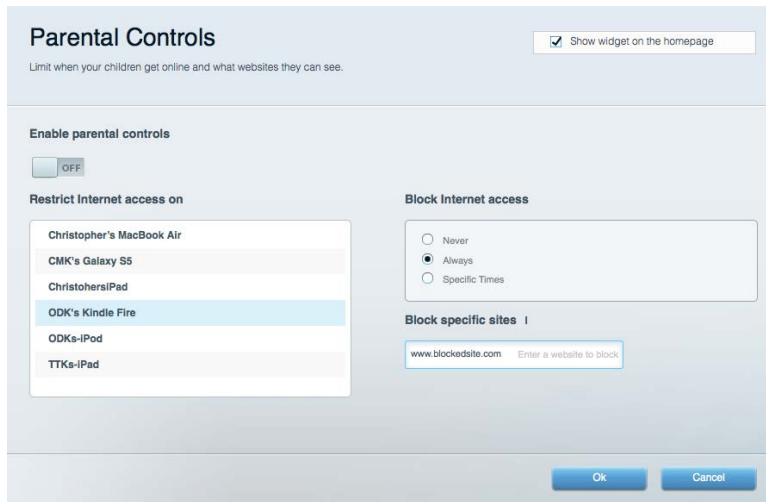

## Priorytetyzacja multimediiów

Umożliwia określenie, które urządzenia i aplikacje mają najwyższy priorytet w ruchu sieciowym.

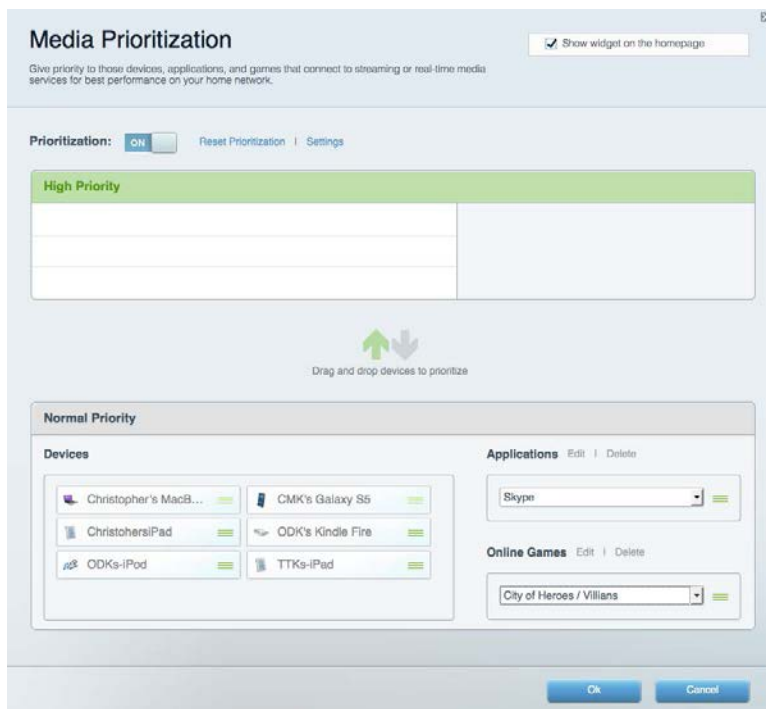

## Test szybkości

Umożliwia przetestowanie szybkości łącza internetowego.



## Zewnętrzna pamięć masowa

Umożliwia uzyskanie dostępu do podłączonego napędu USB (nie jest dostarczany w zestawie) i skonfigurowanie udostępniania plików, serwera multimediiów oraz dostępu FTP.

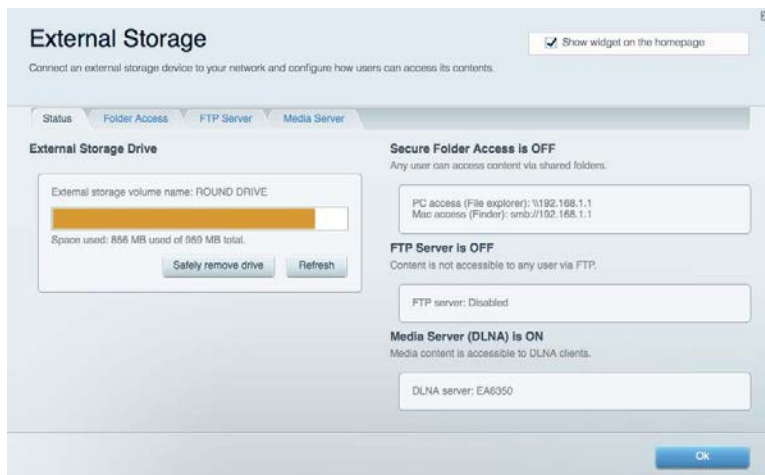

## Połączenia

Umożliwia wyświetlanie i zmianę podstawowych oraz zaawansowanych ustawień sieciowych.

The screenshot shows the 'Connectivity' settings page. It has a title bar with a close button and a subtitle 'View and change router settings'. Below the title bar are several tabs: 'Basic', 'Internet Settings', 'Local Network', 'Advanced Routing', 'VLAN', and 'Administration'. The 'Basic' tab is selected. The page is divided into several sections: 'Network Name and Password' with fields for 2.4 GHz and 5 GHz network names and passwords; 'Router Password' with a masked password field; 'Router Firmware Update' with a checked 'Automatic' option and a 'Check for Updates' button; 'Time Zone' with a dropdown menu set to '(GMT-05:00) Eastern Time (USA & Canada)' and a checked 'Automatically adjust for Daylight Savings Time' option; and 'Activity Lights' with an 'ON' toggle and a text box explaining the power light behavior. At the bottom, there are 'Ok', 'Cancel', and 'Apply' buttons.

## Rozwiązywanie problemów

Pozwala na zdiagnozowanie problemów z routerem i sprawdzanie stanu sieci.

The screenshot shows the 'Troubleshooting' settings page. It has a title bar with a close button and a subtitle 'Troubleshoot router settings'. Below the title bar are three tabs: 'Status', 'Diagnostics', and 'Logs'. The 'Diagnostics' tab is selected. The page is divided into several sections: 'Ping IPv4' with input fields for IP or host name and number of pings, and a 'Start to Ping' button; 'Trace route' with an input field for IP or host name and a 'Start to Traceroute' button; 'Reboot' with a 'Reboot the router' link; 'Router configuration' with 'Backup' and 'Restore' buttons; 'Router Firmware' with a 'Restore previous firmware' button; 'Internet Address' showing IPv4 and IPv6 addresses with 'Release and Renew' links; and 'Factory reset' with a 'Reset to factory default settings' link. At the bottom, there is an 'Ok' button.

## Łączność bezprzewodowa

Umożliwia wyświetlanie i zmianę sieci bezprzewodowej w routerze. Można zmienić nazwy sieci, tryb zabezpieczeń, hasło, filtrowanie MAC, a także podłączać urządzenia za pomocą funkcji Wi-Fi Protected Setup.

The screenshot shows the 'Wireless' settings page. At the top, there is a 'Show widget on the homepage' checkbox which is checked. Below this, there are tabs for 'Wireless', 'MAC Filtering', and 'Wi-Fi Protected Setup'. The 'Smart Connect' section has two radio buttons: '5 GHz band steering' (selected) and 'Off'. Below this, there are two network configuration sections. The first is for the 2.4 GHz network, with the name 'arachnid', password 'peterparker', and security mode 'WPA2/WPA Mixed'. The second is for the 5 GHz network, with the name 'arachnid\_5GHz', password 'peterparker', and security mode 'WPA2/WPA Mixed'. At the bottom, there are 'Ok', 'Cancel', and 'Apply' buttons.

## Zabezpieczenie

Umożliwia wyświetlanie i zmianę zabezpieczeń sieci bezprzewodowej w routerze. Można skonfigurować zaporę, ustawienia VPN, a także wybrać niestandardowe ustawienia dla aplikacji i gier.

The screenshot shows the 'Security' settings page. It has tabs for 'Firewall', 'DMZ', and 'Apps and Gaming'. The 'Firewall' section is active and contains several sub-sections: 'Firewall' with 'IPv4 SPI firewall protection' and 'IPv6 SPI firewall protection' both checked; 'VPN Passthrough' with 'IPSec Passthrough', 'PPTP Passthrough', and 'L2TP Passthrough' all checked; and 'Internet filters' with 'Filter anonymous Internet requests' checked and 'Filter idnet (Port 113)' also checked. At the bottom, there is a table for 'IPv6 Port Services' with columns for Description, Protocol, IPv6 Address, Allow, and Enabled. Below the table is an 'Add IPv6 Firewall Setting' button. At the very bottom, there are 'Ok', 'Cancel', and 'Apply' buttons.

# Rozwiązywanie problemów

Więcej pomocnych porad można znaleźć w naszych wyróżnianych zasobach pomocy technicznej pod adresem [linksys.com/support/EA8300](https://linksys.com/support/EA8300).

## Router nie został prawidłowo skonfigurowany

Jeśli Linksys Smart Wi-Fi nie ukończył prawidłowo konfiguracji, można spróbować następujących metod:

- Naciśnij i przytrzymaj przycisk Reset routera za pomocą spinacza biurowego dopóty, dopóki logo Linksys nie podświetli się, a niebieskie wskaźniki MU\_MIMO nie zaczną migać (ok. 10 sekund). Ponownie przeprowadź instalację routera.

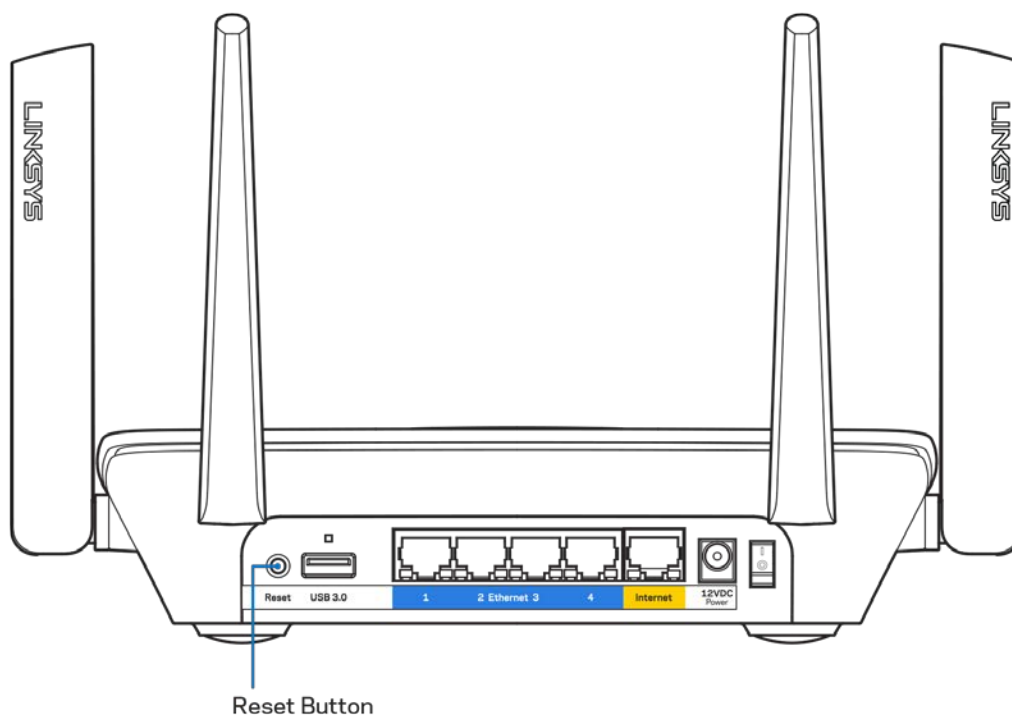

- Tymczasowo wyłącz zaporę (firewall) komputera. Odpowiednią instrukcję można znaleźć w dokumentacji oprogramowania zabezpieczającego komputer. Ponownie przeprowadź instalację routera.
- Jeśli masz drugi komputer, spróbuj zainstalować router z tego drugiego komputera.

## Komunikat *Your Internet cable is not plugged in* (Kabel internetowy nie jest podłączony)

Postępowanie w przypadku wyświetlenia komunikatu „Your Internet cable is not plugged in” (Kabel internetowy nie jest podłączony) podczas konfigurowania routera.

- Upewnij się, że kabel ethernetowy lub internetowy (lub kabel taki jak ten dostarczony z routerem) jest prawidłowo podłączony do żółtego gniazda Internet z tyłu routera oraz do odpowiedniego gniazda modemu. To gniazdo w modemie zazwyczaj jest oznaczone jako „Ethernet”.

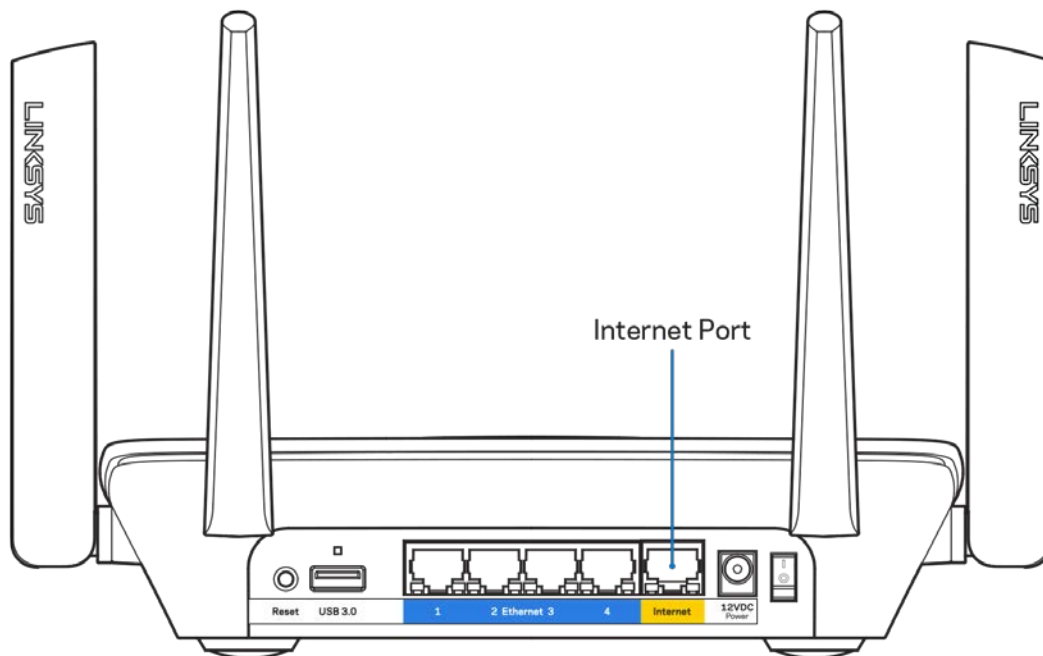

- Upewnij się, że modem jest podłączony do zasilania i włączony. Jeśli modem ma wyłącznik, upewnij się, że wyłącznik ten jest w pozycji ON (Wł.) lub I (a nie O).

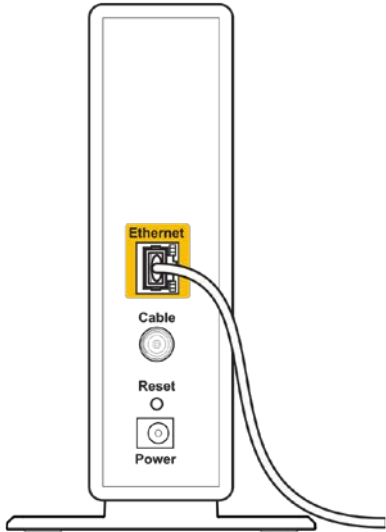
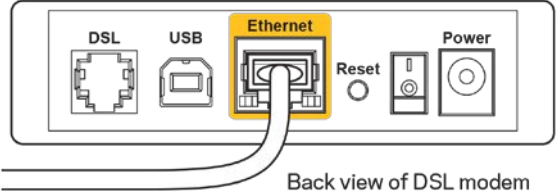

 <p>Back view of cable modem</p>	 <p>Back view of DSL modem</p>
<p>Jeśli korzystasz z kablowego połączenia z Internetem, sprawdź, czy do gniazda CABLE modemu jest podłączony kabel koncentryczny udostępniony przez dostawcę Internetu.</p>	<p>Jeśli korzystasz z usługi DSL, upewnij się, że linia telefoniczna została podłączona do gniazda DSL modemu.</p>

- Jeśli komputer został wcześniej podłączony do modemu za pomocą kabla USB, odłącz ten kabel USB.
- Ponownie przeprowadź instalację routera.

## Komunikat o braku dostępu do routera (*Cannot access your router*)

Aby uzyskać dostęp do routera, konieczne jest posiadanie połączenia z własną siecią domową. Jeżeli użytkownik łączy się z Internetem za pomocą sieci bezprzewodowej, należy sprawdzić, czy przypadkowo nie połączył się z inną siecią.

Aby naprawić ten problem w komputerze z systemem Windows, wykonaj następujące czynności:\*

1. Kliknij ikonę połączeń bezprzewodowych w zasobniku systemowym. Wyświetlana jest lista dostępnych sieci.

2. Kliknij nazwę swojej sieci domowej. Kliknąć przycisk Connect (Połącz). W poniższym przykładzie komputer był podłączony do innej sieci bezprzewodowej o nazwie wraith\_5GHz. Nazwa sieci bezprzewodowej routera Linksys EA8300, w tym przykładzie Damaged\_Beez2.4, jest pokazana jako zaznaczona.



3. Jeśli konieczne jest wpisanie klucza zabezpieczającego, wpisz hasło (klucz zabezpieczający) w polu security key (klucz zabezpieczający). Kliknij przycisk OK.
4. Komputer nawiązuje połączenie z siecią i powinno być już możliwe nawiązanie połączenia z routerem.

*\*W zależności od wersji systemu Windows nazwy opcji lub ikony mogą być inne niż w przedstawionej instrukcji.*

Aby naprawić ten problem w komputerze Mac, wykonaj następujące czynności:

1. Na pasku menu w górnej części ekranu kliknąć ikonę Wi-Fi. Wyświetlana jest lista sieci bezprzewodowych.
2. W poniższym przykładzie komputer był podłączony do innej sieci bezprzewodowej o nazwie wraith\_5GHz. Nazwa sieci bezprzewodowej routera Linksys EA8300, w tym przykładzie Damaged\_Beez2.4, jest pokazana jako zaznaczona.



3. Kliknij nazwę sieci bezprzewodowej routera Linksys EA8300 (w tym przykładzie Damaged\_Beez2.4).
4. Wpisz hasło sieci bezprzewodowej (*Security Key*) w polu Password (Hasło). Kliknij przycisk **OK**.

## Po konfiguracji

### Internet jest niedostępny

Jeśli występują problemy z komunikacją routera z Internetem, może się to objawiać komunikatem „Nie można otworzyć strony...” w przeglądarce internetowej. Jeśli wiesz, że adres internetowy jest prawidłowy i spróbowano kilku prawidłowych adresów internetowych z takim samym wynikiem, komunikat ten może oznaczać problem u dostawcy Internetu, ewentualnie problem z komunikacją na linii modem-router. Spróbuj wykonać następujące czynności:

- Upewnij się, że kable sieciowy i zasilania są prawidłowo podłączone.
- Upewnij się, że w gnieździe zasilania, do którego podłączony jest router, jest prąd.
- Zrestartuj router.
- Skontaktuj się z dostawcą Internetu i spytaj, czy w Twoim regionie nie wystąpiła awaria Internetu.

Najpowszechniejszą metodą rozwiązywania problemów z routerem jest jego wyłączenie i ponowne włączenie. Router ładuje wtedy ponownie niestandardowe ustawienia, a inne urządzenia (np. modem) wykrywają go ponownie i od nowa nawiązują komunikację. Takie ponowne włączenie określa się jako „restart”.

Restartowanie routera przez odłączenie kabla zasilania:

1. Odłącz kabel zasilania od routera i modemu.
2. Odczekaj 10 sekund i ponownie podłącz przewód zasilania do modemu. Upewnij się, że zasilanie jest dostarczane.
3. Odczekaj aż wskaźnik online modemu przestanie migać (ok. dwóch minut). Ponownie podłącz kabel zasilania do routera.

4. Oczekaj, aż logo Linksys się podświetli. Po dwóch minutach spróbuj ponownie nawiązać połączenie z Internetem z komputera.

Aby zrestartować router z poziomu interfejsu Linksys Smart Wi-Fi:

1. Zaloguj się do interfejsu Linksys Smart Wi-Fi. (Patrz „Uzyskiwanie dostępu do interfejsu Linksys Smart Wi-Fi” na stronie [11](#).)
2. W części *Router Settings* (Ustawienia routera) kliknij *Troubleshooting* (Rozwiązywanie problemów).
3. Kliknij kartę *Diagnostics* (Diagnostyka).
4. W części *Reboot* (Restart) kliknij *Reboot* (Restart).



5. Kliknij **Yes** („Tak”). Router zostaje zrestartowany. Kiedy router jest restartowany, wszystkie podłączone do niego urządzenia tracą łączność z Internetem. Ponownie nawiążą połączenie, kiedy router będzie znów gotowy do pracy.

## Interfejs Linksys Smart Wi-Fi nie otwiera się w przeglądarce.

Najnowsze wersje Google Chrome™, Firefox®, Safari® (dla urządzeń Mac® i iPad®), Microsoft Edge oraz Internet Explorer® wersja 8 i nowsze współpracują z interfejsem Linksys Smart Wi-Fi.

# Parametry techniczne

## Linksys EA8300

Nazwa modelu	Max-Stream AC2200 MU-MIMO Tri-Band Router
Numer modelu	EA8300
Szybkość przełączanych portów	10/100/1000 Mb/s (Gigabit Ethernet)
Częstotliwość radiowa	2,4 GHz oraz 5 GHz (x2)
Liczba anten	4 regulowanych anten zewnętrznych (nieodłączanych)
Gniazda	USB 3.0, Ethernet (1-4), Internet, zasilanie
Przyciski	Wi-Fi Protected Setup, zasilanie, resetowanie
Światła/wskaźniki	<b>Panel górny:</b> Podświetlane logo Linksys, Wi-Fi Protected Setup, połączenie internetowe, podłączenie kabla sieciowego do gniazda Internet <b>Panel tylny:</b> USB, Ethernet (1-4), Internet
UPnP	Obsługiwany
Funkcje bezpieczeństwa	WEP, WPA2, RADIUS
Klucz zabezpieczeń	Maks. 128-bitowy
Obsługiwane systemów plików	FAT, NTFS oraz HFS+
Obsługiwane przeglądarki	Najnowsze wersje przeglądarek Google Chrome™, Firefox®, Safari® (Mac® i iPad®), Microsoft Edge i przeglądarka Internet Explorer® w wersji 8 lub nowszej.

## Parametry fizyczne i środowiskowe

Wymiary	213,7mm x 161,8mm x 54,8mm (bez anten)
Waga urządzenia	608 g
Zasilanie	12V, 2A
Certyfikaty	FCC, IC, CE, Wi-Fi (a/b/g/n/ac)
Temperatura pracy	od 32 do 104°F (od 0 do 40°C)
Temperatura przechowywania	od -4 do 140°F (od -20 do 60°C)
Wilgotność podczas pracy	10 - 80% (wilgotność względna bez kondensacji)
Wilgotność przy przechowywaniu	od 5% do 90%, bez kondensacji

Parametry techniczne mogą ulec zmianie bez uprzedzenia.

Uwagi:

Informacje wymagane przepisami, gwarancyjne oraz dotyczące bezpieczeństwa można znaleźć na płycie dołączonej do routera lub na stronie [Linksys.com/support/EA8300](http://Linksys.com/support/EA8300).

Maksymalna wydajność oparta na standardzie IEEE 802.11. Rzeczywista wydajność może odbiegać od nominalnej. Może to dotyczyć m.in. mniejszej przepustowości sieci bezprzewodowej, szybkości przesyłania danych, zasięgu i obszaru pokrycia. Osiągi zależą od wielu czynników, warunków i zmiennych, w tym odległości od punktu dostępowego, natężenia ruchu sieciowego, materiałów i konstrukcji budynku, używanego systemu operacyjnego, używanych urządzeń bezprzewodowych, zakłóceń itp.

BELKIN, LINKSYS oraz wiele nazw i znaków graficznych produktów jest znakami towarowymi grupy spółek Belkin. Wymienione tutaj znaki towarowe innych firm stanowią własność odpowiednich podmiotów. Licencje i noty dot. oprogramowania innych dostawców stosowanego w tym produkcie: <http://support.linksys.com/en-us/license>. Pytania dotyczące kodu open source lub licencji GPL: <http://support.linksys.com/en-us/gplcodecenter>.

© 2017 Belkin International, Inc. i spółki stowarzyszone. Wszelkie prawa zastrzeżone.

**LINKSYS®**

Guia do utilizador

**ROUTER TRI-BAND**

**MAX-STREAM™  
AC2200 MU-MIMO**

Modelo EA8300

# Índice

Descrição Geral do Produto .....	3
Vista superior.....	3
Indicador de estado do sistema .....	4
Vista traseira.....	5
Vista lateral .....	6
Configuração: operações básicas.....	7
Onde obter mais ajuda .....	7
Como instalar o seu router .....	8
Como Utilizar o Linksys Smart Wi-Fi.....	11
Como ligar ao Linksys Smart Wi-Fi.....	11
Mapa de rede.....	12
Acesso para convidados .....	12
Controlo parental.....	13
Prioridade de multimédia .....	13
Teste de velocidade.....	14
Armazenamento externo .....	14
Conectividade.....	15
Resolução de problemas.....	15
Sem fios .....	16
Segurança.....	16
Resolução de problemas .....	17
O router não foi configurado com sucesso.....	17
Mensagem <i>Your Internet cable is not plugged in</i> (O seu cabo de Internet não está ligado) .....	18
Mensagem <i>Cannot access your router</i> (Não é possível aceder ao router).....	19
Após a configuração.....	21
A internet parece não estar disponível.....	21
O Linksys Smart Wi-Fi não abre o seu navegador web .....	22
Especificações.....	23
Linksys EA8300 .....	23
Ambiente .....	23



# Descrição Geral do Produto

## Vista superior

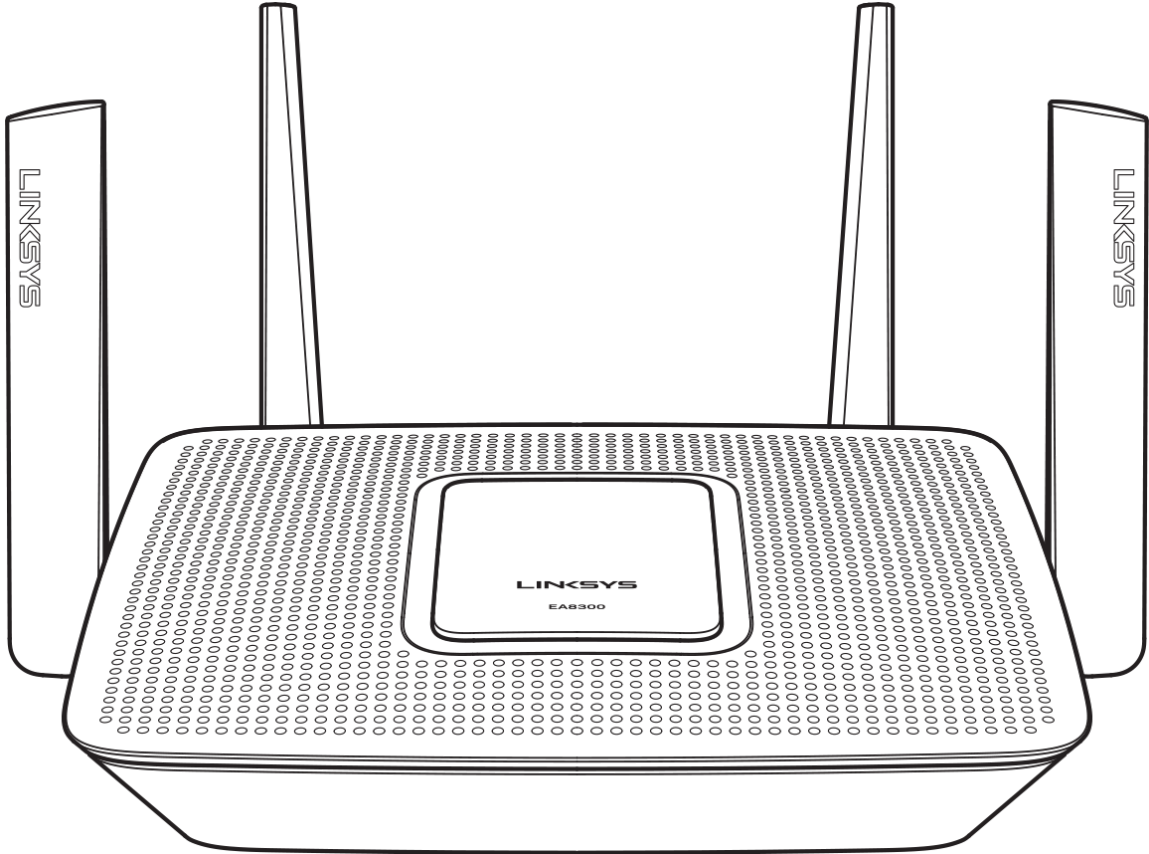

## Indicador de estado do sistema

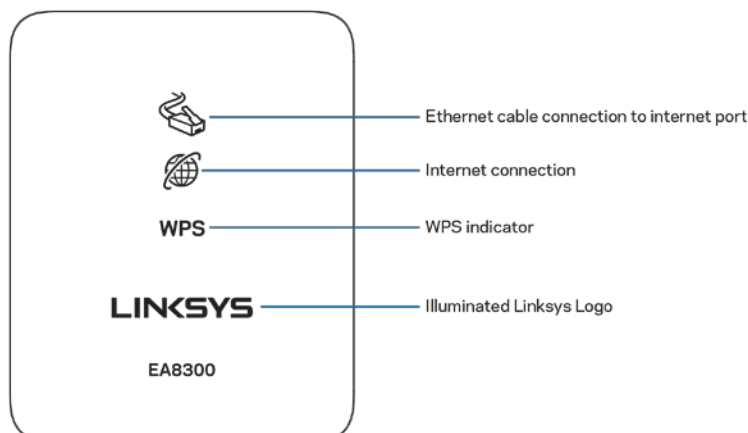

**Ligação de cabo Ethernet à porta da Internet** — Quando aceso (a laranja), indica um problema com o cabo de rede ligado à porta de Internet (WAN).

**Ligação à Internet** — Quando aceso (a laranja), indica que o router não consegue ter acesso à internet.

**Indicador WPS (Wi-Fi Protected Setup™)** — A luz de WPS tem quatro estados:

<b>Desligado</b>	Sem atividade de Wi-Fi Protected Setup
<b>Piscar a branco</b>	Ligação Wi-Fi Protected Setup em progresso
<b>Branco sólido</b>	Ligação Wi-Fi Protected Setup bem-sucedida; a luz fica acesa durante cinco segundos
<b>Piscar a laranja</b>	Erro de Wi-Fi Protected Setup; pisca durante um minuto, depois apaga-se

**Logótipo Linksys Iluminado** — O logótipo pisca enquanto o router está a iniciar. Quando a luz do logótipo está acesa branca fixa, o router está ligado e a funcionar corretamente.

## Vista traseira

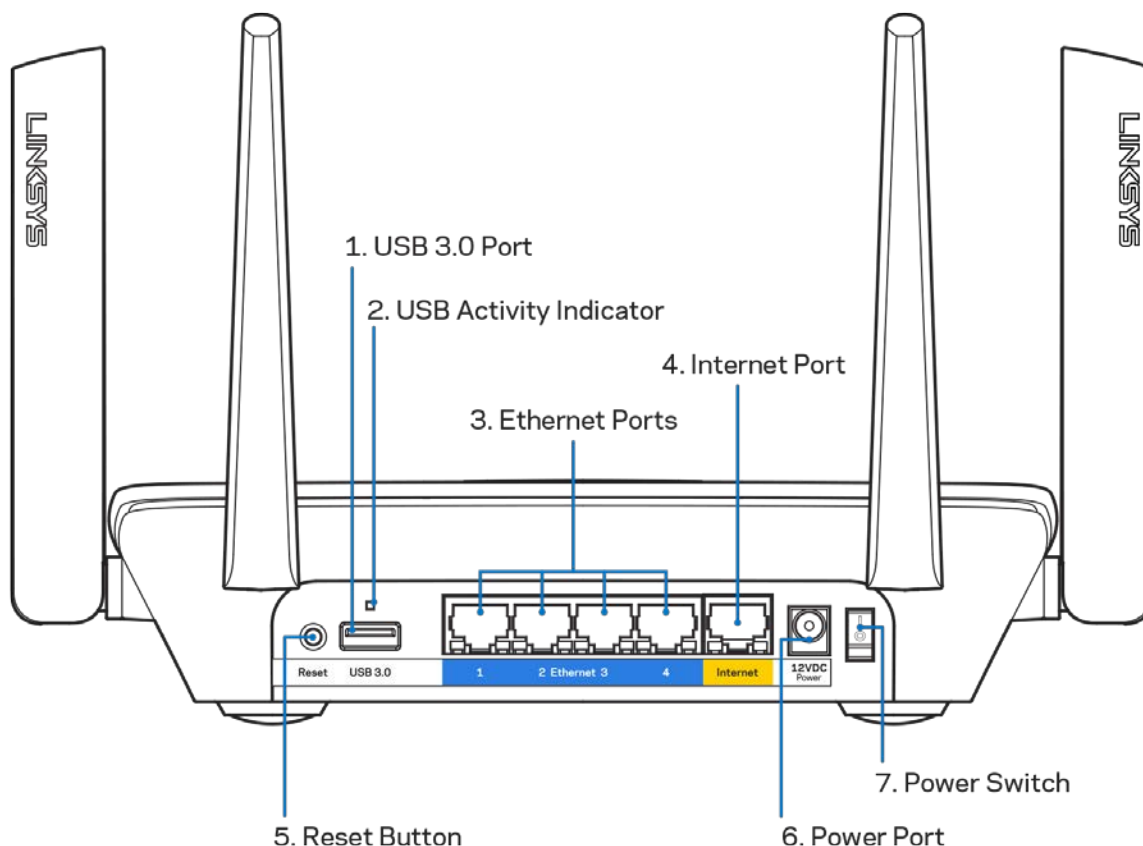

**Porta USB 3.0 (1)**— Ligue e partilhe unidades USB na sua rede ou na internet.

**Indicador de atividade USB (2)**— As luzes indicam transferência de e para dispositivos externos.

**Portas Ethernet (3)**—Ligue os cabos ethernet a estas portas gigabit azuis (10/100/1000) e aos dispositivos com fios da sua rede.

*Note* Para melhor desempenho, utilize cabos CAT5e ou com classificação superior nas portas ethernet.

**Porta Internet (4)**— Ligue um cabo ethernet a esta porta gigabit (10/100/1000) amarela e a um modem internet de cabo/DSL ou fibra de banda larga.

*Note* Para melhor desempenho, utilize cabo CAT5e ou com classificação superior na porta Internet.

**Botão de reposição (5)**—Prima e mantenha premido até o logótipo Linksys iluminado se apagar para repor o router nas predefinições de fábrica. Também pode repor as predefinições utilizando o Linksys Smart Wi-Fi na internet ou a aplicação móvel.

**Porta de Alimentação (6)**- Ligue o transformador CA incluído.

**Interruptor de alimentação (7)**—Prima | (ligado) para ligar o router.

## Vista lateral

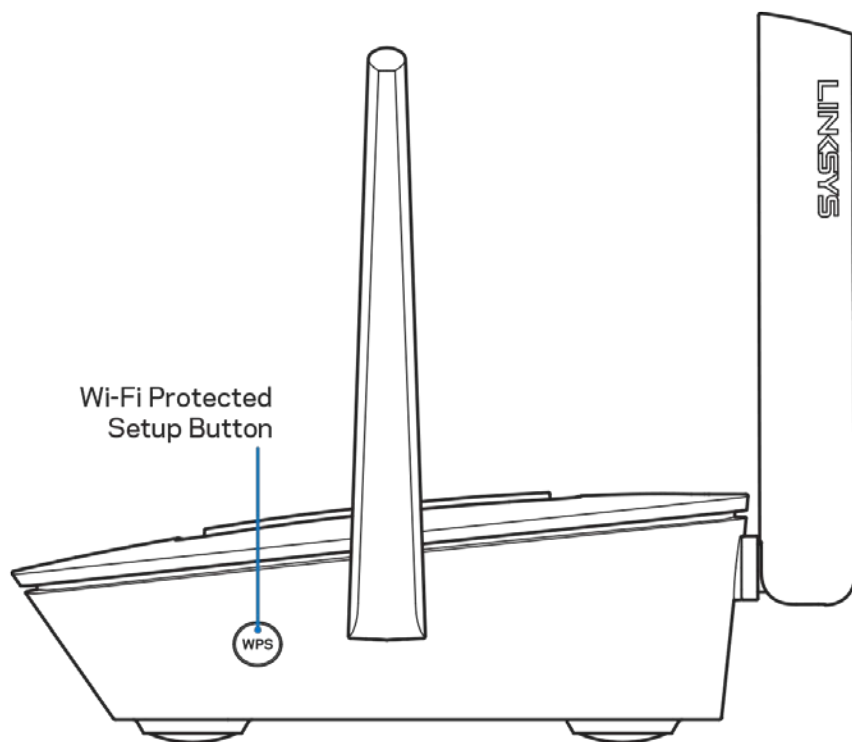

**Botão Wi-Fi Protected Setup™**— Prima para efetuar ligação de dispositivos preparados para WPS.

# Configuração: operações básicas

## Onde obter mais ajuda

Além deste manual de utilizador, poderá encontrar ajuda nestes locais:

- [Linksys.com/support/EA8300](http://Linksys.com/support/EA8300) (documentação, descarregamentos, perguntas frequentes, assistência técnica, conversaçoão chat ao vivo, fóruns)
- Ajuda Linksys Smart Wi-Fi (ligue-se a Linksys Smart Wi-Fi, depois clique em Help (Ajuda) no topo do ecrã)

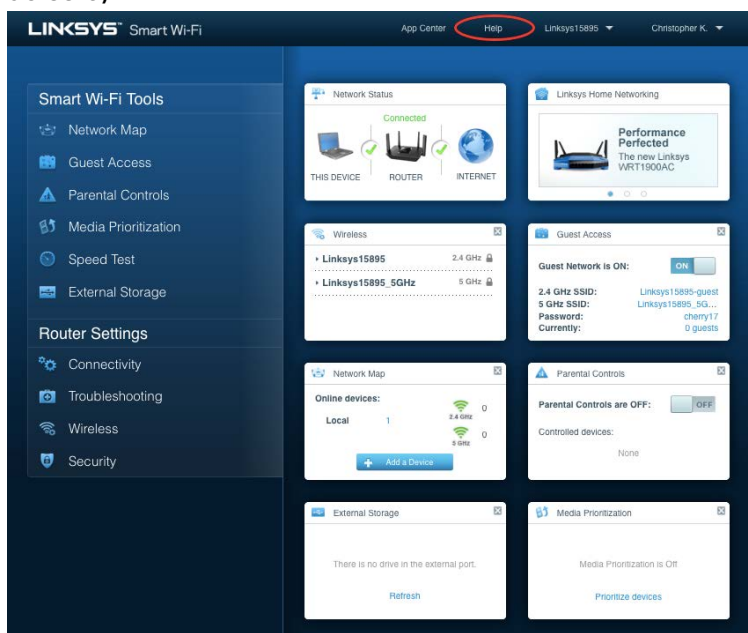

The screenshot shows the Linksys Smart Wi-Fi web interface. The top navigation bar includes 'App Center', 'Help' (highlighted with a red circle), 'Linksys15895', and 'Christopher K.'. The main content area is divided into several sections: 'Smart Wi-Fi Tools' (Network Map, Guest Access, Parental Controls, Media Prioritization, Speed Test, External Storage), 'Router Settings' (Connectivity, Troubleshooting, Wireless, Security), 'Network Status' (Connected), 'Linksys Home Networking' (Performance Perfected), 'Wireless' (Linksys15895 2.4 GHz, Linksys15895\_5GHz 5 GHz), 'Guest Access' (Guest Network is ON), 'Network Map' (Online devices: Local 1), 'Parental Controls' (Parental Controls are OFF), 'External Storage' (There is no drive in the external port), and 'Media Prioritization' (Media Prioritization is Off).

**Help**

**Using Linksys Smart Wi-Fi**

Linksys Smart Wi-Fi allows you to access all of your router's features and settings. Simply click on a feature or widget you want to open.

You can use Linksys Smart Wi-Fi to:

- See what's currently connected to your network, and connect more computers and devices.
- Create a Linksys Smart Wi-Fi account to access router settings from anywhere using any browser, even when you're away from home. You can personalize your router and change settings for wireless access, Internet, gaming, local network, and more. You can even access router settings for multiple routers, which is helpful if you set up and manage more than one router. (The account is available only on EA-Series routers.)
- Allow guests in your home to use the Internet without giving them access to your network. While on the guest network, users can surf the net, but won't be able to access your printers, other computers, or devices on your network.

**Help Categories**

- Linksys Smart Wi-Fi
- Device List
- Guest Access
- Parental Controls
- Media Prioritization
- Speed Test
- External Storage
- Connectivity

Ok

**Nota**—As licenças e avisos para software de terceiros utilizados neste produto poderão ser vistos em <http://support.linksys.com/en-us/license>. Contacte <http://support.linksys.com/en-us/gplcodecenter> para perguntas ou pedidos de código fonte GPL.

## Como instalar o seu router

1. Para concluir a configuração, precisa de um computador para visitar <http://LinksysSmartWiFi.com> num navegador web.
2. Identifique o seu equipamento.

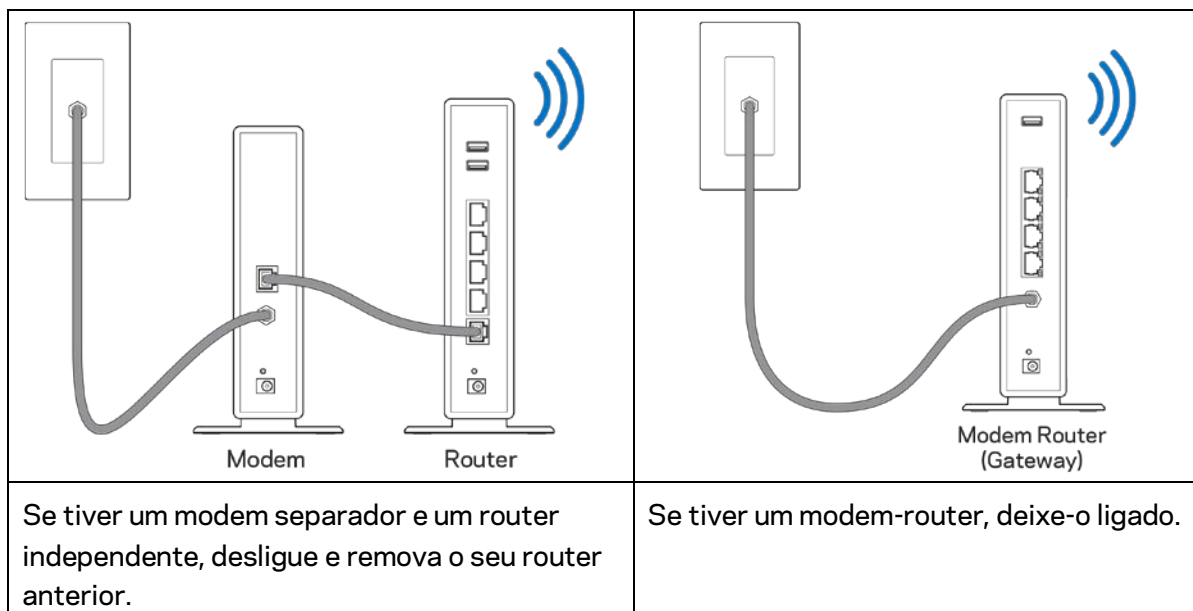

3. Posicione as antenas na vertical e ligue o router à fonte de alimentação. Verifique se o interruptor de corrente está na posição I (ligado).
4. Ligue o seu router ao seu modem ou modem router. Ligue uma extremidade do cabo de internet incluído à porta amarela de internet no seu novo router. Se tiver um modem, ligue a outra extremidade à porta Ethernet (LAN) no modem. Se tiver um modem router, ligue-o a qualquer porta disponível.
5. Espere até a luz Linksys acesa no topo do router parar de piscar e ficar branco estável.
6. Ligue ao nome Wi-Fi no Guia de início rápido que vem com o seu router. (Pode alterar estas definições mais tarde.) Se precisar de ajuda a ligar-se à rede, consulte a documentação do seu dispositivo em [linksys.com/support/EA8300](http://linksys.com/support/EA8300).

**Nota**—Não terá acesso à internet até a configuração do router ser terminada.

7. Insira <http://LinksysSmartWiFi.com> num web browser. Siga as instruções no ecrã para terminar a configuração do seu router. Também pode escrever 192.168.1.1 num navegador para iniciar a configuração.

No final da configuração, siga as instruções no ecrã para configurar a sua conta Linksys Smart Wi-Fi. Utilize o Linksys Smart Wi-Fi para configurar o seu router a partir de qualquer computador com uma ligação à internet.

Gerir as definições do seu router:

- Alterar o nome e a palavra-passe do seu router
- Configurar o acesso de convidados
- Configurar os controlos parentais
- Ligar dispositivos à sua Wi-Fi
- Testar a velocidade da ligação à internet

**Nota**—*Como parte da configuração da conta Linksys Smart Wi-Fi, ser-lhe-á enviado um e-mail de verificação. A partir da sua rede doméstica, clique na hiperligação no email para associar o seu router à conta Linksys Smart Wi-Fi.*

**Dica**—*Imprima a página seguinte, depois registe o seu router e as definições de conta na tabela como referência. Guarde as suas notas num local seguro.*

Nome da Wi-Fi de 2,4 GHz	
Palavra-passe do Wi-Fi	
Nome da Wi-Fi de 5 GHz <sub>1</sub>	
Palavra-passe do Wi-Fi	
Nome da Wi-Fi de 5 GHz <sub>2</sub>	
Palavra-passe do Wi-Fi	
Palavra-passe do Router	
Nome da Wi-Fi de convidado de 2,4 GHz	
Nome da Wi-Fi de convidado de 5GHz	
Palavra-passe de Wi-Fi de convidado (Ambas as redes de convidado partilham uma palavra-passe.)	
Nome de utilizador do Linksys Smart Wi-Fi	
Palavra-passe do Linksys Smart Wi-Fi	



# Como Utilizar o Linksys Smart Wi-Fi

Pode gerir o seu router a partir de qualquer lugar no mundo, utilizando o Linksys Smart Wi-Fi, mas também pode fazê-lo diretamente a partir da sua rede doméstica. O Linksys Smart Wi-Fi também poderá estar disponível no seu equipamento móvel. Veja a app store do seu equipamento para mais informação.

## Como ligar ao Linksys Smart Wi-Fi

Para ligar o Linksys Smart Wi-Fi:

1. Abra o navegador web do seu computador.
2. Vá a <http://LinksysSmartWiFi.com> e inicie sessão na sua conta.

Caso não se consiga lembrar da sua palavra-passe, clique em *Forgot your password?* (Esqueceu-se da sua palavra-passe?) e siga as instruções presentes no ecrã para a recuperar.

## Mapa de rede

Permite-lhe visualizar e gerir todos os dispositivos de rede ligados ao seu router. Pode ver os dispositivos na sua rede principal e na sua rede de convidado, ou ver informação sobre cada dispositivo.



## Acesso para convidados

Permite-lhe criar e monitorizar uma rede para os convidados terem acesso Wi-Fi sem expor informação pessoal.

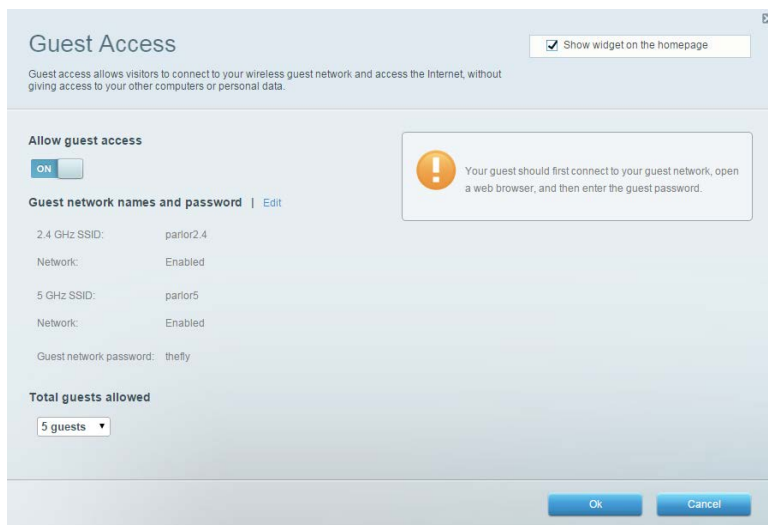

## Controlo parental

Permite-lhe bloquear Web sites e definir horários de acesso à internet.

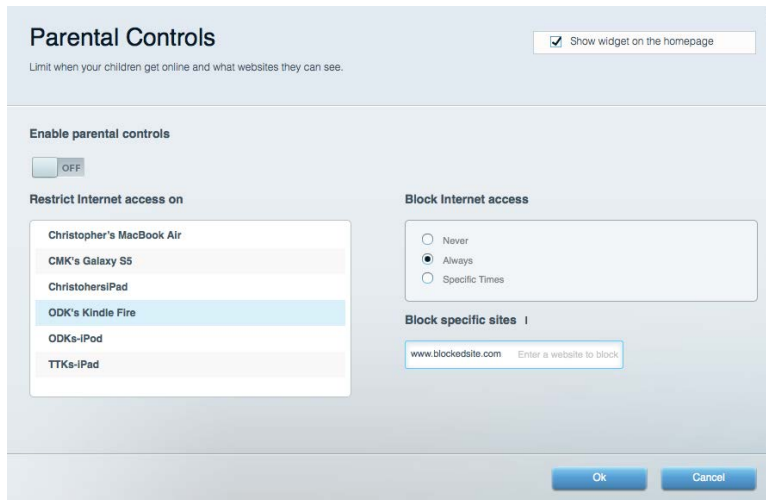

## Prioridade de multimédia

Permite-lhe definir quais os dispositivos e aplicações que têm máxima prioridade no seu tráfego de rede.

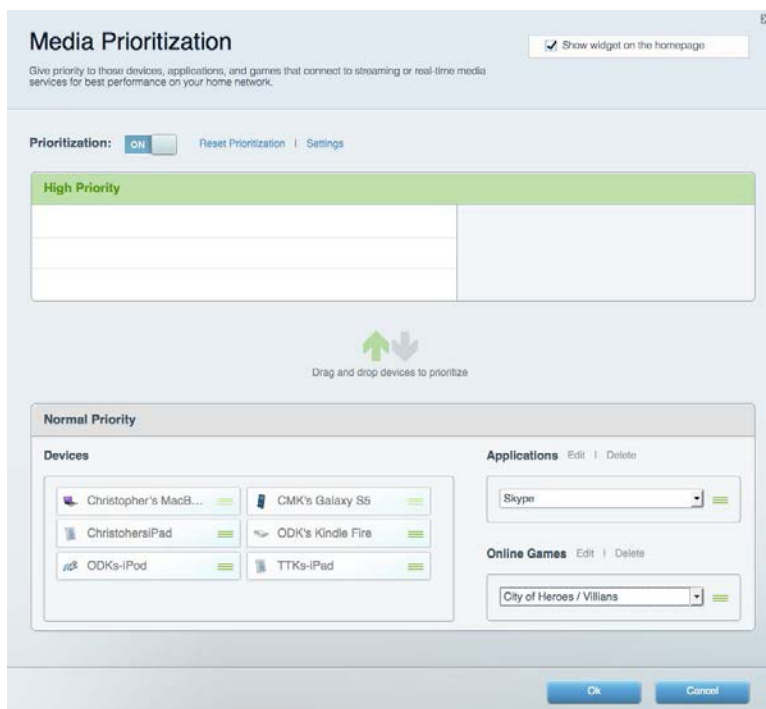

## Teste de velocidade

Permite-lhe testar a velocidade de ligação de internet da sua rede.



## Armazenamento externo

Permite-lhe aceder a uma unidade USB acoplada (não incluída) e configurar a partilha de ficheiros, um servidor multimédia e acesso FTP.



## Conectividade

Permite-lhe ver e alterar definições de rede básicas e avançadas.

The screenshot shows the 'Connectivity' settings page. It has a sub-header 'View and change router settings' and a navigation bar with tabs: Basic, Internet Settings, Local Network, Advanced Routing, VLAN, and Administration. The 'Basic' tab is selected. The page is divided into several sections: 'Network Name and Password' with fields for 2.4 GHz and 5 GHz network names and passwords; 'Router Password' with a masked password field; 'Router Firmware Update' with a checked 'Automatic' option and a 'Check for Updates' button; 'Time Zone' with a dropdown menu set to '(GMT-05:00) Eastern Time (USA & Canada)' and a checked 'Automatically adjust for Daylight Savings Time' option; and 'Activity Lights' with an 'ON' toggle and a text box. At the bottom, there are 'Ok', 'Cancel', and 'Apply' buttons.

## Resolução de problemas

Permite-lhe diagnosticar problemas com o seu router e verificar o estado da rede.

The screenshot shows the 'Troubleshooting' page with the sub-header 'Troubleshoot router settings'. It has a navigation bar with tabs: Status, Diagnostics, and Logs. The 'Diagnostics' tab is selected. The page is divided into several sections: 'Ping IPv4' with input fields for IP or host name and number of pings, and a 'Start to Ping' button; 'Trace route' with an input field for IP or host name and a 'Start to Traceroute' button; 'Reboot' with a 'Reboot the router' link; 'Router configuration' with 'Backup' and 'Restore' buttons; 'Router Firmware' with a 'Restore previous firmware' button; 'Internet Address' showing IPv4 and IPv6 addresses with 'Release and Renew' links; and 'Factory reset' with a 'Reset to factory default settings' link. An 'Ok' button is at the bottom right.

## Sem fios

Permite-lhe ver e alterar a rede sem fios do seu router. Pode alterar os nomes de rede, modo de segurança, palavra-passe, filtro MAC e ligar dispositivos utilizando a Wi-Fi Protected Setup.

The screenshot shows the 'Wireless' settings page. At the top, there's a 'Show widget on the homepage' checkbox which is checked. Below that, there are tabs for 'Wireless', 'MAC Filtering', and 'Wi-Fi Protected Setup'. The 'Smart Connect' section has two radio buttons: '5 GHz band steering' (selected) and 'Off'. Below this, there are two network configuration sections. The first is for the 2.4 GHz network, with the name 'arachnid', password 'peterparker', and security mode 'WPA2/WPA Mixed Pk'. The second is for the 5 GHz network, with the name 'arachnid\_5GHz', password 'peterparker', and security mode 'WPA2/WPA Mixed Pk'. At the bottom, there are 'Ok', 'Cancel', and 'Apply' buttons.

## Segurança

Permite-lhe ver e alterar a segurança sem fios do seu router. Pode configurar a firewall, definições da VPN e criar definições personalizadas para aplicações e jogos.

The screenshot shows the 'Security' settings page. It has tabs for 'Firewall', 'DMZ', and 'Apps and Gaming'. The 'Firewall' section is active. Under 'Firewall', there are checkboxes for 'IPv4 SPI firewall protection' and 'IPv6 SPI firewall protection', both of which are checked and labeled 'Enabled'. Under 'VPN Passthrough', there are checkboxes for 'IPSec Passthrough', 'PPTP Passthrough', and 'L2TP Passthrough', all of which are checked and labeled 'Enabled'. Under 'Internet filters', there are checkboxes for 'Filter anonymous Internet requests', 'Filter multicast', 'Filter Internet NAT redirection', and 'Filter ident (Port 113)'. The 'Filter ident (Port 113)' checkbox is checked. At the bottom, there is a table for 'IPv6 Port Services' with columns for 'Description', 'Protocol', 'IPv6 Address', 'Allow', and 'Enabled'. Below the table is an 'Add IPv6 Firewall Setting' button. At the bottom of the page, there are 'Ok', 'Cancel', and 'Apply' buttons.

# Resolução de problemas

Pode encontrar ajuda adicional através do nosso suporte a clientes premiado em [linksys.com/support/EA8300](http://linksys.com/support/EA8300).

## O router não foi configurado com sucesso

Se o Linksys Smart Wi-Fi não concluiu a configuração, pode tentar o seguinte:

- Mantenha premido o botão Reset no seu router com um clip de papel ou pin até o logótipo Linksys iluminado se apagar e os indicadores MU-MIMO azuis começarem a piscar (cerca de 10 segundos). Volte a instalar o router.

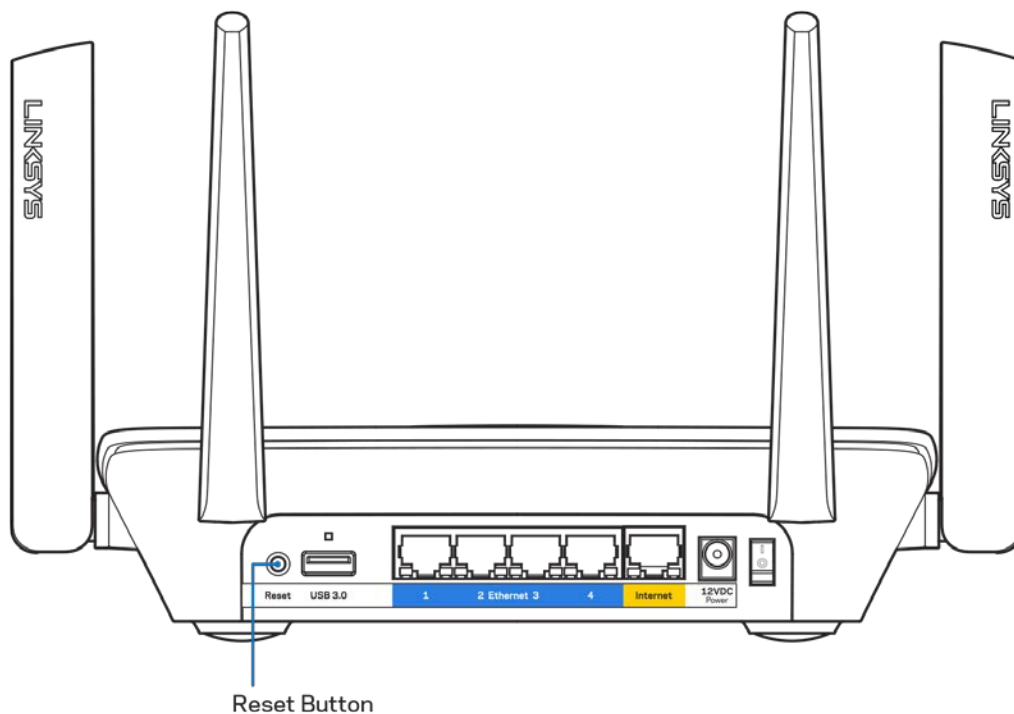

- Desative temporariamente a firewall do computador (ver instruções de software de segurança para obter ajuda). Volte a instalar o router.
- Se tiver outro computador, use esse computador para voltar a instalar o router.

## Mensagem *Your Internet cable is not plugged in* (O seu cabo de Internet não está ligado)

Se receber uma mensagem do tipo "O cabo de internet não está ligado" quando tentar configurar o seu router, siga estes passos de resolução de problemas.

- Certifique-se de que um cabo ethernet ou de internet (ou um cabo semelhante ao fornecido com o seu router) está firmemente seguro à porta de internet amarela na parte de trás do router e à porta apropriada no seu modem. Esta porta no modem é normalmente assinalada como Ethernet.

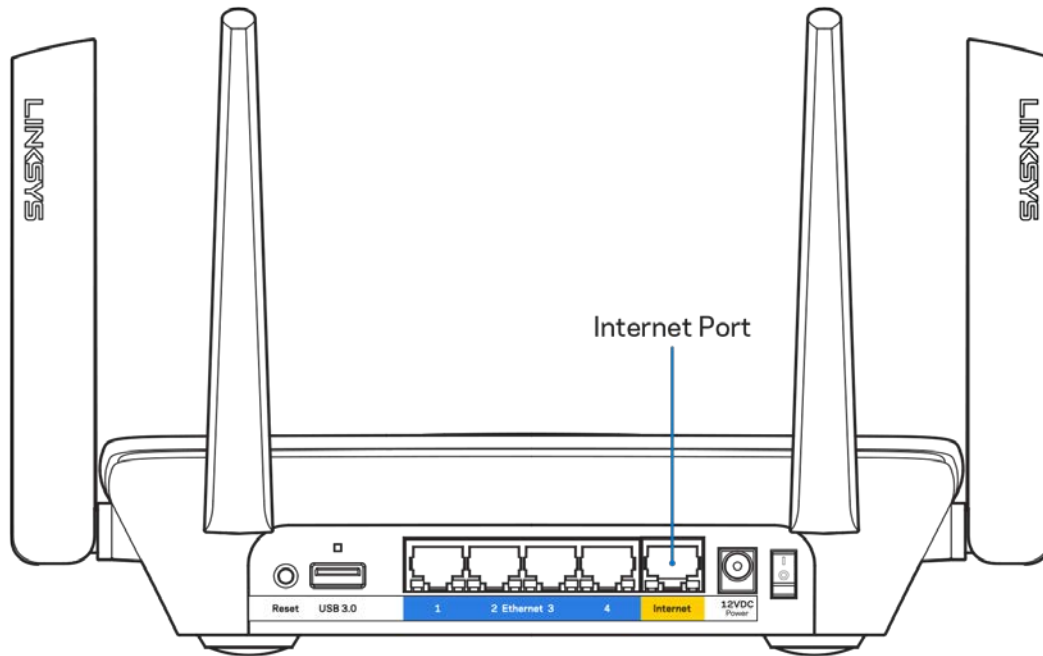

- Certifique-se de que o seu modem está ligado à alimentação e está ligado. Se tiver um interruptor, verifique se está na posição ON ou | (por oposição a O)

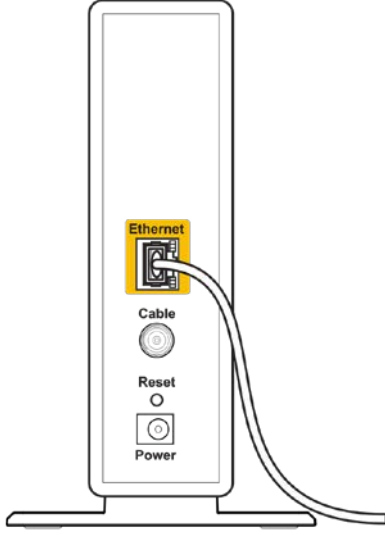
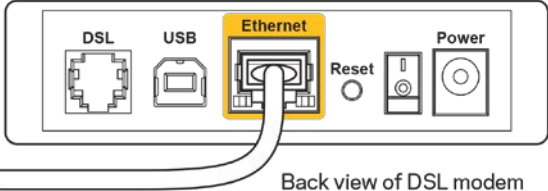

 <p>Back view of cable modem</p>	 <p>Back view of DSL modem</p>
<p>Se o seu serviço de internet for por cabo, verifique que a porta CABLE do modem de cabo está ligado ao cabo coaxial fornecido pelo seu ISP.</p>	<p>Se o serviço de internet for do tipo DSL, certifique-se que a linha de telefone DSL está ligada à porta DSL do modem.</p>

- Se o seu computador tiver sido previamente ligado ao seu modem com um cabo USB, desligue o cabo USB.
- Volte a instalar o router.

## Mensagem *Cannot access your router* (Não é possível aceder ao router)

Para aceder ao seu router, tem de estar ligado à sua própria rede. Se tem acesso à internet sem fios, o problema pode residir no facto de se ter ligado acidentalmente a uma rede sem fios diferente.

Para corrigir o problema em computadores Windows, tente o seguinte\*:

1. Clique no ícone de comunicação sem fios no tabuleiro do sistema. Irá aparecer uma lista de redes disponíveis.

2. Clique no nome da sua rede. Clique em Ligar. No exemplo abaixo, o computador estava ligado a outra rede sem fios chamada wraith\_5GHz. O nome da rede sem fios do router Linksys EA8300, Damaged\_Beez2.4 neste exemplo, encontra-se selecionado.



3. Se lhe for pedido que insira uma chave de segurança de rede, escreva a sua palavra-passe (chave de segurança) no seu campo de *chave de segurança* de rede. Clique em **OK**.
4. O seu computador irá ligar-se à rede e deverá ter acesso ao router.

*\*Dependendo da versão do Windows, poderá haver alguma diferença nas palavras ou ícones nestes passos.*

Para corrigir o problema em computadores Mac, tente o seguinte:

1. Na barra de menu no topo do ecrã, clique no ícone Wi-Fi. Irá aparecer uma lista de redes sem fios.
2. No exemplo abaixo, o computador estava ligado a outra rede sem fios chamada wraith\_5GHz. O nome da rede sem fios do router Linksys EA8300, Damaged\_Beez2.4 neste exemplo, encontra-se selecionado.



3. Clique no nome da rede sem fios do seu router Linksys EA8300 (Damaged\_Beez2.4 no exemplo).
4. Escreva a sua palavra-passe de rede sem fios (Chave de Segurança) no campo *Password* (Palavra-passe). Clique em **OK**.

## Após a configuração

### A internet parece não estar disponível

Se a internet tiver dificuldade em comunicar com o seu router, o problema poderá aparecer como uma mensagem "Não é possível encontrar [Endereço de internet]" no seu navegador web. Caso saiba que o endereço de internet está correto e tentou vários endereços de internet válidos e obteve o mesmo resultado, a mensagem pode significar que houve um problema com a comunicação entre o seu ISP ou modem com o router. Tente o seguinte:

- Certifique-se de que os cabos de rede e alimentação estão ligados de forma segura.
- Certifique-se que a saída de alimentação a que o seu router está ligado tem alimentação elétrica.
- Reinicie o router.
- Contacte o seu ISP e pergunte-lhe se existem interrupções na sua área.

O método mais comum de resolver problemas do seu router é desligá-lo e depois voltar a ligá-lo. O seu router pode depois voltar a carregar as suas definições personalizadas e os outros equipamentos (como o modem) serão capazes de voltar a descobrir o router e a comunicar com ele. A este processo chama-se reinicialização.

Para reiniciar o seu router utilizando o cabo de alimentação, faça o seguinte:

1. Desligue o cabo de alimentação do router e do modem.
2. Espere 10 segundos e volte a ligar o cabo de alimentação ao modem. Certifique-se de que tem alimentação elétrica.
3. Espere até o indicador online do modem ter parado de piscar (cerca de dois minutos). Volte a ligar o cabo de alimentação ao router.
4. Aguarde até que o logótipo Linksys iluminado esteja aceso. Espere dois minutos antes de se tentar ligar à internet a partir de um computador.

Para reiniciar o seu router utilizando o Linksys Smart Wi-Fi, faça o seguinte:

1. Inicie sessão no Linksys Smart Wi-Fi. (Veja "Como ligar ao Linksys Smart Wi-Fi" na página [11](#)).
2. Por baixo de *Router Settings* (Definições de router), clique em *Troubleshooting* (Resolução de problemas).
3. Clique no separador *Diagnostics* (Diagnósticos).
4. Por baixo de *Reboot* (Reiniciar), clique em *Reboot* (Reiniciar).



5. Clique em **Yes** (Sim). O router irá reiniciar. Enquanto o router está a reiniciar, todos os equipamentos ligados irão perder a ligação à internet e irão automaticamente voltar a ligar-se quando o router estiver novamente pronto.

## O Linksys Smart Wi-Fi não abre o seu navegador web

As mais recentes versões do Google Chrome™, Firefox®, Safari® (para Mac® e iPad®), Microsoft Edge e Internet Explorer® versão 8 e mais recentes funcionam com o Linksys Smart Wi-Fi.

# Especificações

## Linksys EA8300

Nome do modelo	Router Tri-band Max-Stream AC2200 MU-MIMO
Número do modelo	EA8300
Velocidade da Porta Switch	10/100/1000 Mbps (Gigabit Ethernet)
Frequência de rádio	2,4 GHz e 5 GHz (x2)
N.º de antenas	4 antenas externas ajustáveis (não amovíveis)
Portas	USB 3.0, Ethernet (1-4), Internet, Alimentação
Botões	Wi-Fi Protected Setup, Alimentação, Reset
Luzes	<b>Painel superior:</b> Logótipo da Linksys Iluminado, Wi-Fi Protected Setup, Ligação à Internet, Ligação de cabo de rede à porta da internet <b>Painel posterior:</b> USB, Ethernet (1-4), Internet
UPnP	Suportado
Funcionalidades de segurança	WEP, WPA2, RADIUS
Bits da chave de segurança	Encriptação até 128 bits
Suporte de Sistema de Armazenamento de Ficheiro	FAT, NTFS e HFS+
Suporte de navegador	As mais recentes versões do Google Chrome™, Firefox®, Safari® (para Mac® e iPad®), Microsoft Edge e Internet Explorer® versão 8 e mais recentes

## Ambiente

Dimensões	213,7mm x 161,8mm x 54,8mm (sem antenas)
Peso do aparelho	608 g
Energia	12 V, 2A
Certificações	FCC, IC, CE, Wi-Fi (a/b/g/n/ac)
Temperatura de serviço	0 a 40°C (32 a 104°F)
Temperatura de armazenamento	-20 a 60°C (-4 a 140°F)
Humidade de funcionamento	10% a 80% de humidade relativa, sem condensação
Humidade de armazenamento	5% a 90%, sem condensação

As especificações podem ser alteradas sem aviso prévio.

Notas:

Para informação regulamentar, de garantia e de segurança, consulte o CD que veio com o seu router ou vá a [Linksys.com/support/EA8300](http://Linksys.com/support/EA8300).

Desempenho máximo determinado a partir das especificações da norma IEEE 802.11. O desempenho real poderá variar dependendo de uma menor capacidade da rede sem fios, da velocidade do débito de dados, do alcance e da cobertura. O desempenho depende de diversos fatores, condições e variáveis, incluindo a distância ao ponto de acesso, o volume do tráfego na rede, os materiais de construção, o sistema operativo utilizado, a mistura de produtos sem fios utilizados, as interferências e outras condições adversas.

BELKIN, LINKSYS e muitos nomes de produtos e logótipos são marcas comerciais do grupo de empresas Belkin. As marcas comerciais de terceiros mencionadas pertencem aos seus respetivos proprietários. As licenças e avisos para software de terceiros utilizado neste produto poderão ser vistos aqui: <http://support.linksys.com/en-us/license>. Contacte <http://support.linksys.com/en-us/gplcodecenter> para questões ou pedidos de código fonte GPL.

© 2017 Belkin International, Inc. e/ou os seus afiliados. Todos os direitos reservados.

**LINKSYS®**

Guia do usuário

**MAX-STREAM™  
AC2200 MU-MIMO  
ROTEADOR TRIBANDA**

Modelo EA8300

# Conteúdo

Visão geral do produto .....	3
Vista da parte superior .....	3
Indicador de status do sistema .....	4
Visão traseira .....	5
Visão lateral .....	6
Definindo: Básico .....	7
Onde posso obter ajuda .....	7
Como instalar o roteador .....	8
Como usar o Linksys Smart Wi-Fi .....	11
Como conectar o Linksys Smart Wi-Fi .....	11
Mapa da rede .....	12
Acesso como convidado .....	12
Controle de acesso .....	13
Priorização de mídia .....	13
Teste de velocidade .....	14
Armazenamento externo .....	14
Conectividade .....	15
Resolução de problemas .....	15
Sem fio .....	16
Segurança .....	16
Resolução de problemas .....	17
Seu roteador não foi configurado .....	17
Mensagem "O cabo de internet não está conectado" .....	18
Mensagem "Não é possível acessar o roteador" .....	19
Após a configuração .....	21
A internet parece estar indisponível .....	21
O Linksys Smart Wi-Fi não abre em seu navegador de Internet .....	22
Especificações .....	23
Linksys EA8300 .....	23
Informações ambientais .....	23



# Visão geral do produto

## Vista da parte superior

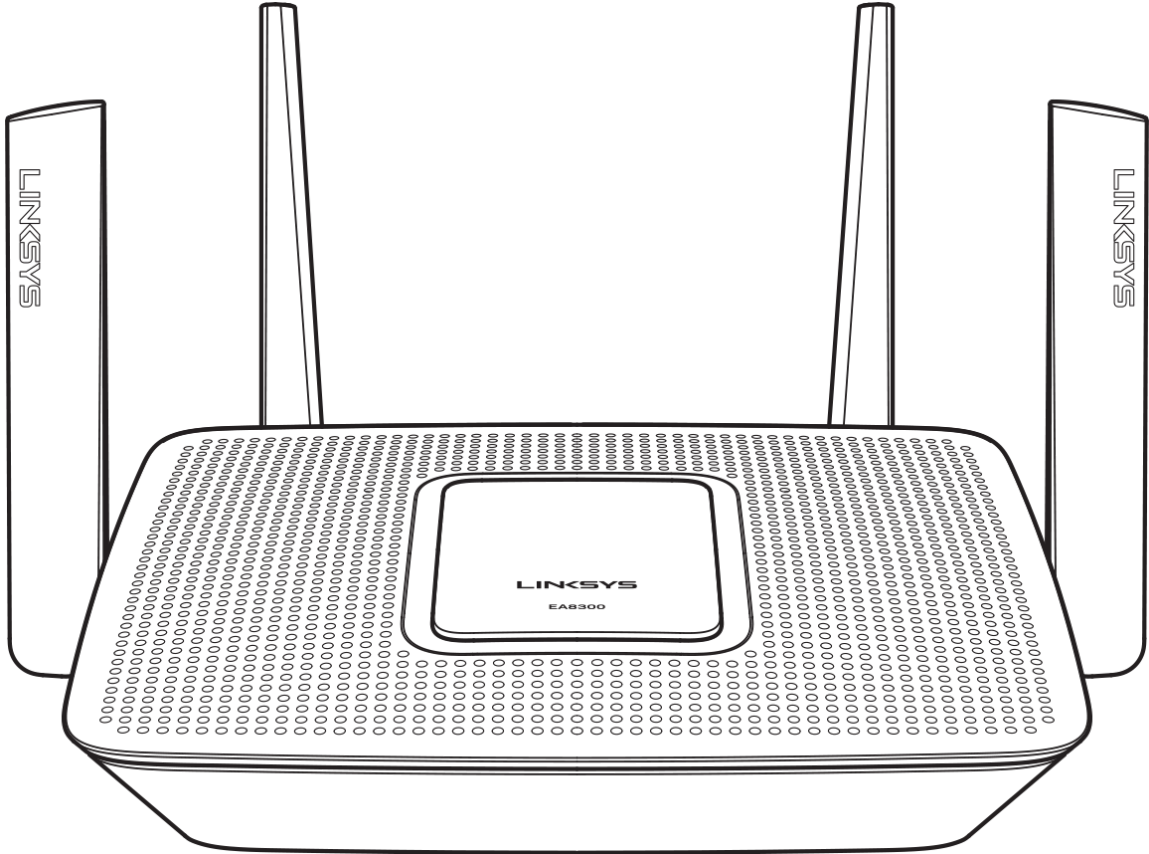

## Indicador de status do sistema

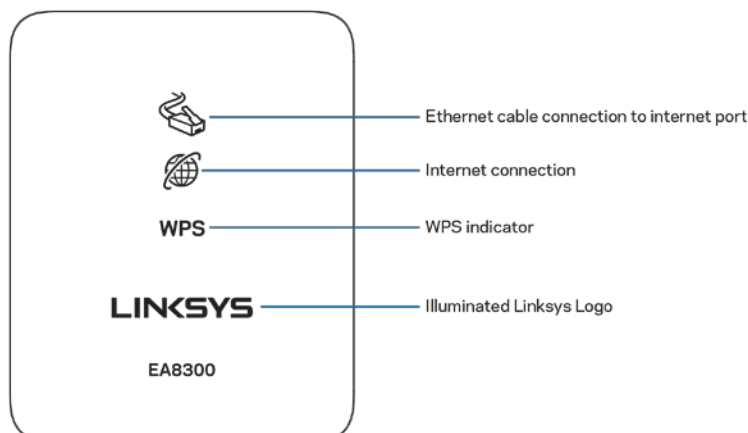

**Porta de conexão de cabo Ethernet à internet (1)** — Quando acesa (laranja), indica um problema com o cabo de rede conectado à porta Internet (WAN).

**Conexão à internet** — Quando acesa (laranja), indica que o roteador não consegue acessar a internet.

**Indicador do WPS (Wi-Fi Protected Setup™)** — A luz WPS tem quatro estados:

<b>Desligado</b>	Sem atividade do Wi-Fi Protected Setup
<b>Branco piscando</b>	Wi-Fi Protected Setup em progresso
<b>Branco sólido</b>	Wi-Fi Protected Setup funcionando; se mantém aceso por cinco segundos
<b>Laranja piscando</b>	Erro no Wi-Fi Protected Setup; pisca por um minuto e desliga

**Logotipo iluminado da Linksys** — Pisca enquanto o roteador está iniciando. Quando o logotipo estiver em branco sólido, o roteador está ligado e funcionando de modo correto.

## Visão traseira

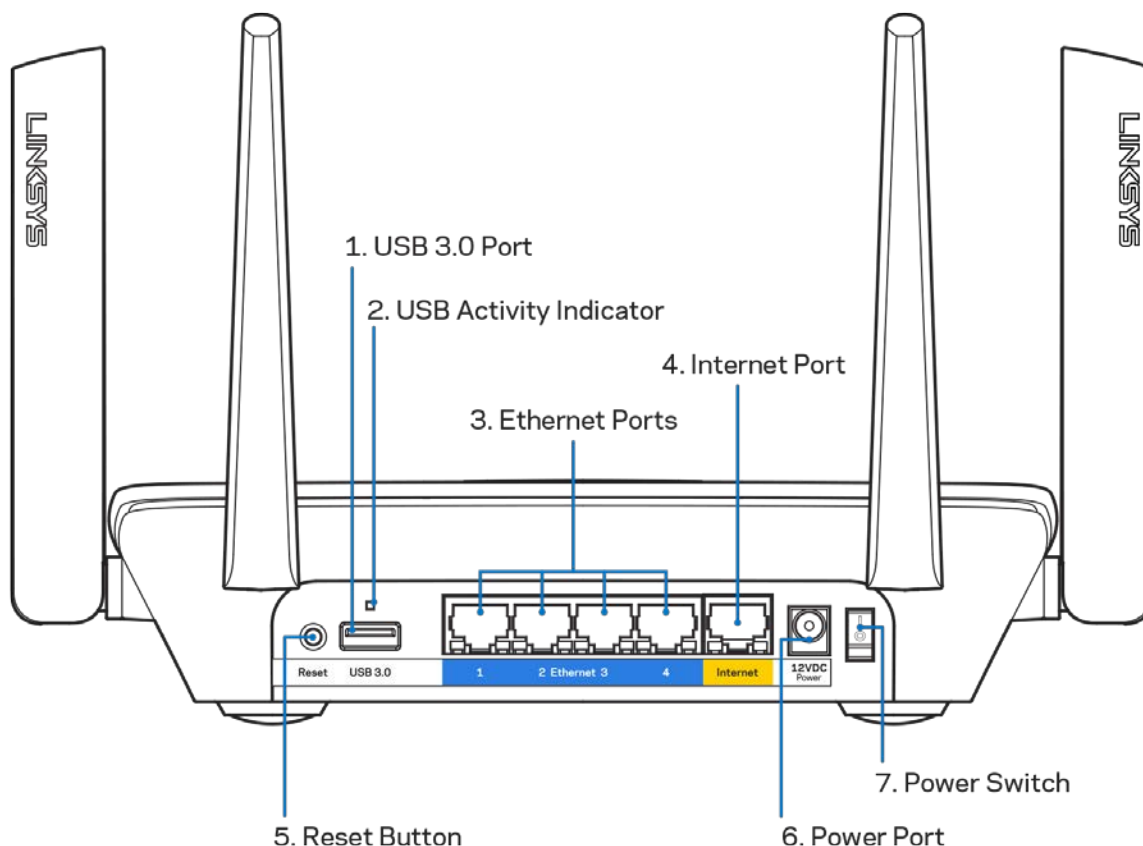

**Porta USB 3.0 (1)** — Conecte e compartilhe unidades USB com a sua rede ou com a internet.

**Indicador de atividade do USB (2)** — As luzes indicam transferência de/para dispositivos externos.

**Portas Ethernet (3)**— Conecte os cabos Ethernet a essas portas Gigabit (10/100/1000), na cor azul, e a dispositivos a cabo na sua rede.

*Nota - Para um melhor desempenho, use cabos CAT5e ou superior nas portas Ethernet.*

**Porta Internet (4)** — Conecte um cabo Ethernet a essa porta Gigabit (10/100/1000), na cor amarela, e a um modem de banda larga a cabo/DSL ou fibra ótica.

*Nota - Para um melhor desempenho, use cabos CAT5e ou superior nas portas de internet.*

**Botão Redefinir (5)** — Mantenha pressionado até que o logotipo iluminado da Linksys desligue para redefinir o roteador e as configurações de fábrica. Também é possível restaurar as configurações padrão usando o Linksys Smart Wi-Fi na internet ou aplicativo móvel.

**Porta de alimentação (6)** - Conecte o adaptador da fonte de alimentação CA.

**Botão interruptor (7)** - Pressione (ligar) para ligar o roteador.

## Visão lateral

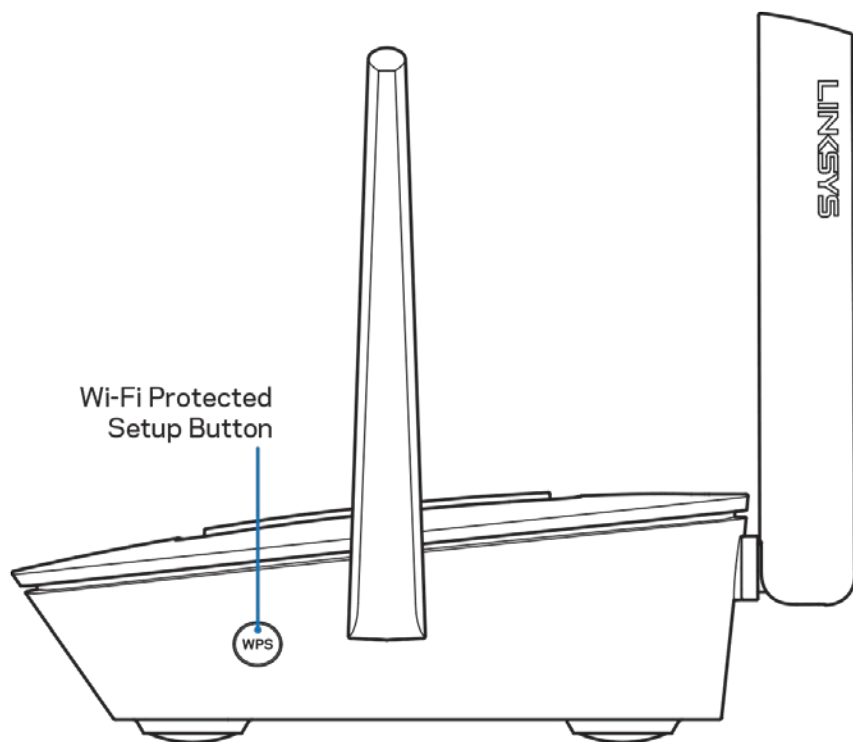

**Botão Wi-Fi Protected Setup™** — Pressione para conectar dispositivos de rede habilitados para WPS.

# Definindo: Básico

## Onde posso obter ajuda

Além deste guia do usuário, é possível obter ajuda nestes locais:

- [Linksys.com/support/EA8300](http://Linksys.com/support/EA8300) (documentação, downloads, FAQs, suporte técnico, bate-papo ao vivo, fóruns)
- Ajuda do Linksys Smart Wi-Fi (conecte-se a Linksys Smart Wi-Fi e clique em Ajuda na parte superior da tela)

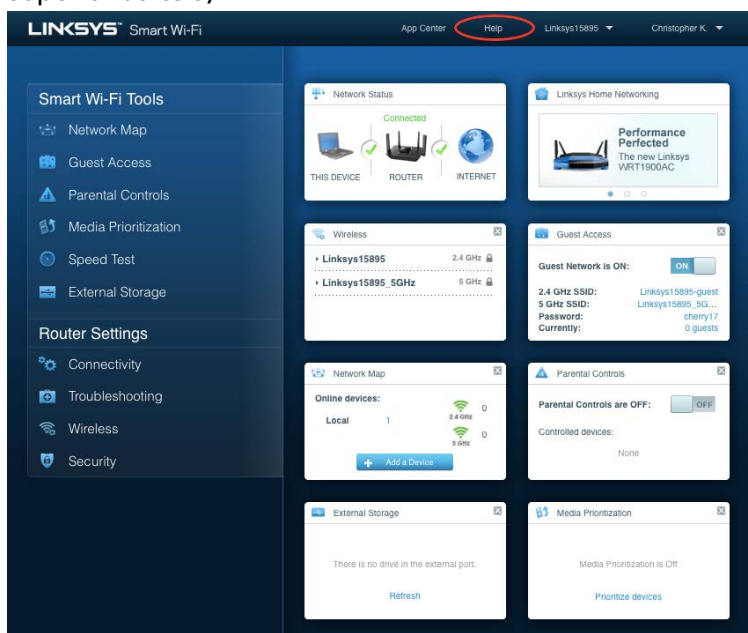

The screenshot shows the Linksys Smart Wi-Fi web interface. The top navigation bar includes 'App Center', 'Help' (highlighted with a red circle), 'Linksys15895', and 'Christopher K.'. The main content area is divided into several sections: 'Smart Wi-Fi Tools' (Network Map, Guest Access, Parental Controls, Media Prioritization, Speed Test, External Storage), 'Router Settings' (Connectivity, Troubleshooting, Wireless, Security), and various status widgets (Network Status, Linksys Home Networking, Wireless, Guest Access, Network Map, Parental Controls, External Storage, Media Prioritization).

### Help

**Using Linksys Smart Wi-Fi**

Linksys Smart Wi-Fi allows you to access all of your router's features and settings. Simply click on a feature or widget you want to open.

You can use Linksys Smart Wi-Fi to:

- See what's currently connected to your network, and connect more computers and devices.
- Create a Linksys Smart Wi-Fi account to access router settings from anywhere using any browser, even when you're away from home. You can personalize your router and change settings for wireless access, Internet, gaming, local network, and more. You can even access router settings for multiple routers, which is helpful if you set up and manage more than one router. (The account is available only on EA-Series routers.)
- Allow guests in your home to use the Internet without giving them access to your network. While on the guest network, users can surf the net, but won't be able to access your printers, other computers, or devices on your network.

**Help Categories**

- Linksys Smart Wi-Fi
- Device List
- Guest Access
- Parental Controls
- Media Prioritization
- Speed Test
- External Storage
- Connectivity

Ok

**Nota-**As licenças e avisos para software de terceiros usadas neste produto estão disponíveis em <http://support.linksys.com/en-us/license>. Entre em contato com <http://support.linksys.com/en-us/gplcodecenter> em caso de dúvidas ou solicitações do código fonte GPL.

## Como instalar o roteador

1. Para completar a configuração, você precisará de um computador para acessar <http://LinksysSmartWiFi.com> em um navegador.
2. Identifique seu equipamento.

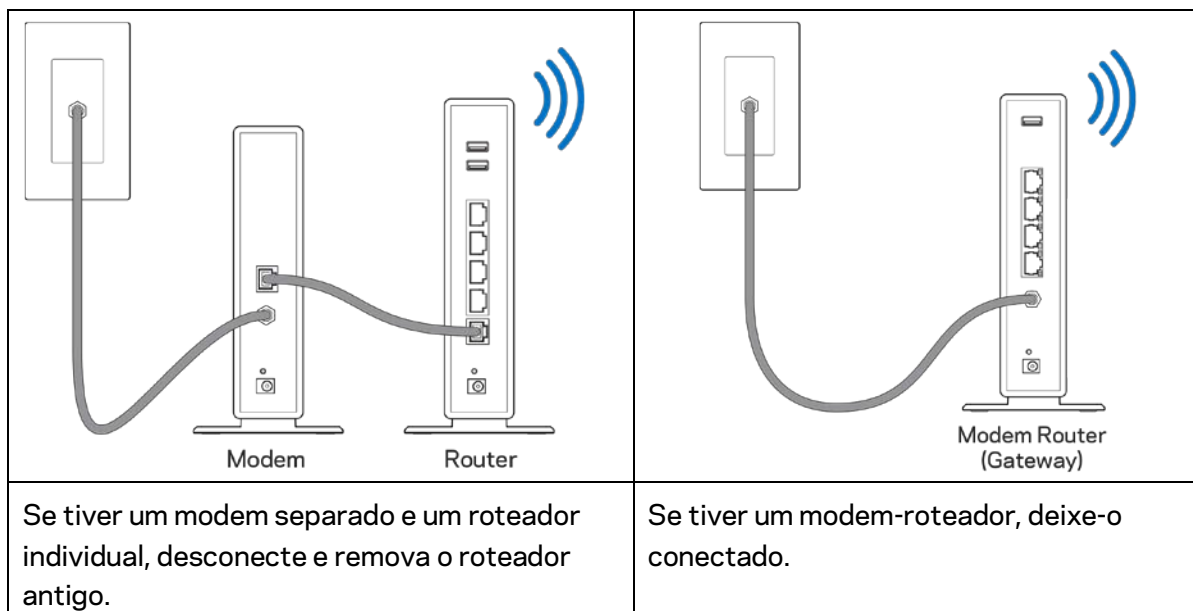

3. Posicione as antenas e conecte o roteador à rede elétrica. Verifique se o botão interruptor está na posição | (ligar).
4. Conecte o roteador ao modem ou modem-roteador. Conecte uma extremidade do cabo de internet fornecido à porta Internet amarela no seu novo roteador. Se tiver um modem, conecte a outra extremidade na porta Ethernet (LAN) no modem. Se tiver um modem roteador, conecte-o em qualquer porta disponível.
5. Espere até que a luz iluminada da Linksys na parte superior do roteador pare de piscar e fique acesa na cor branca.
6. Conecte ao nome de rede sem fio segura mostrado no guia de início rápido que acompanha o roteador. (Você pode alterar esses detalhes posteriormente). Se precisar de ajuda para se conectar à rede, consulte a documentação do dispositivo em [linksys.com/support/EA8300](http://linksys.com/support/EA8300).

**Nota - você não terá acesso à internet até que a configuração do roteador seja concluída.**

7. Digite <http://LinksysSmartWiFi.com> em um navegador. Siga as instruções na tela para completar a instalação do roteador. Você também pode digitar 192.168.1.1 em um navegador para iniciar a configuração.

No fim da configuração, siga as instruções na tela para configurar a sua conta no Linksys Smart Wi-Fi. Use o Linksys Smart Wi-Fi para configurar seu roteador de qualquer computador com conexão à internet.

Gerenciar as configurações do roteador:

- Alterar o nome e senha do roteador
- Configurar acesso do convidado
- Configurar controles de conteúdo inapropriado
- Conectar dispositivos ao Wi-Fi
- Testar a velocidade da conexão à

**Observação** - Como parte da configuração da conta Linksys Smart Wi-Fi, você receberá um e-mail de verificação. De sua rede doméstica, clique no link no e-mail para associar seu roteador com a conta do Linksys Smart Wi-Fi.

**Dica** - Imprima esta página e registre as configurações do roteador e da conta na tabela, como referência. Armazene suas notas em um lugar seguro.

Nome do Wi-Fi de 2,4 GHz	
Senha do Wi-Fi	
5 GHz <sub>1</sub> Nome do Wi-Fi	
Senha do Wi-Fi	
5 GHz <sub>2</sub> Nome do Wi-Fi	
Senha do Wi-Fi	
Senha do roteador	
Nome da rede Wi-Fi de 2.4 GHz do convidado	
Nome da rede Wi-Fi de 5 GHz do convidado	
Senha da rede Wi-Fi do convidado (ambos usam a mesma senha).	
Nome de usuário no Linksys Smart Wi-Fi	
Senha no Linksys Smart Wi-Fi	



# Como usar o Linksys Smart Wi-Fi

Você pode gerenciar seu roteador em qualquer lugar do mundo usando o Linksys Smart Wi-Fi, mas também pode fazer isso diretamente da rede doméstica. O Linksys Smart Wi-Fi pode também estar disponível para seu dispositivo móvel. Consulte a loja de aplicativos do seu dispositivo para obter informações.

## Como conectar o Linksys Smart Wi-Fi

Para se conectar ao Linksys Smart Wi-Fi:

1. Abra o navegador Web de seu computador.
2. Acesse <http://LinksysSmartWiFi.com> e inicie a sessão em sua conta

Linksys Smart Wi-Fi Sign In

If you have not yet created a Linksys Smart Wi-Fi account, click the 'Create Account' button in the upper right corner of the page.

Give guests Internet access

Use your Linksys Smart Wi-Fi account to access your home network from anywhere, at any time, even from your mobile device. Easily connect new devices, set parental controls, get access to Smart Wi-Fi mobile Apps, and more.

For more information click here

English (United States)

For local access, click here.

Se não se lembrar de sua senha, clique em *Esqueceu sua senha?* e siga as instruções na tela para redefini-la.

## Mapa da rede

Permite que você exiba e gerencie todos os dispositivos de redes conectados ao seu roteador. É possível ver os dispositivos na sua rede principal e de convidados, desconectar dispositivos ou exibir informações de cada dispositivo.



## Acesso como convidado

Permite que você instale e monitore a rede para os convidados acessarem a rede Wi-Fi sem que as suas informações pessoais sejam expostas.

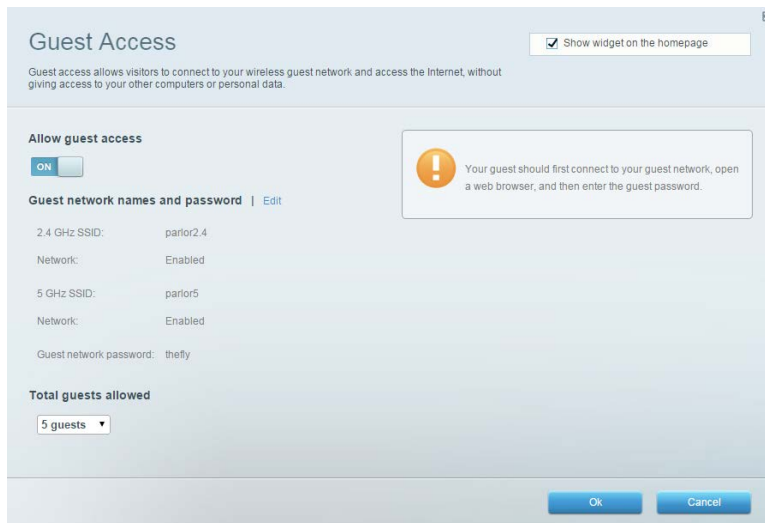

## Controle de acesso

Permite que você bloqueie sites e defina os períodos de acesso à internet.

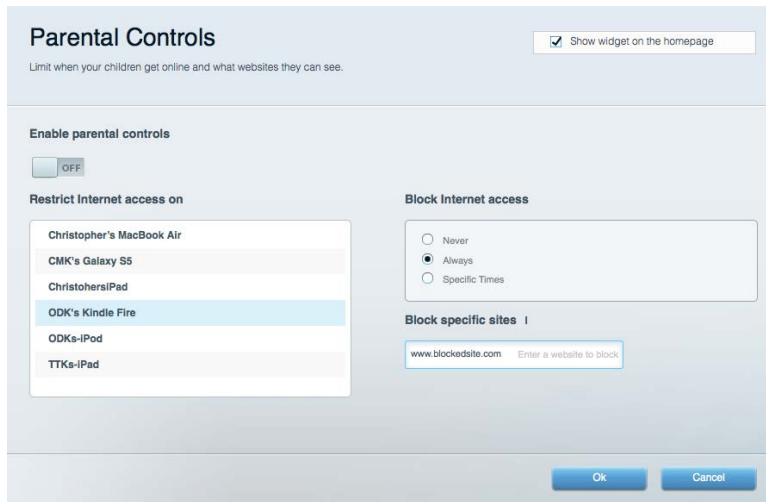

## Priorização de mídia

Permite que você defina quais dispositivos e aplicativos possuem prioridade máxima para o seu tráfego de rede.

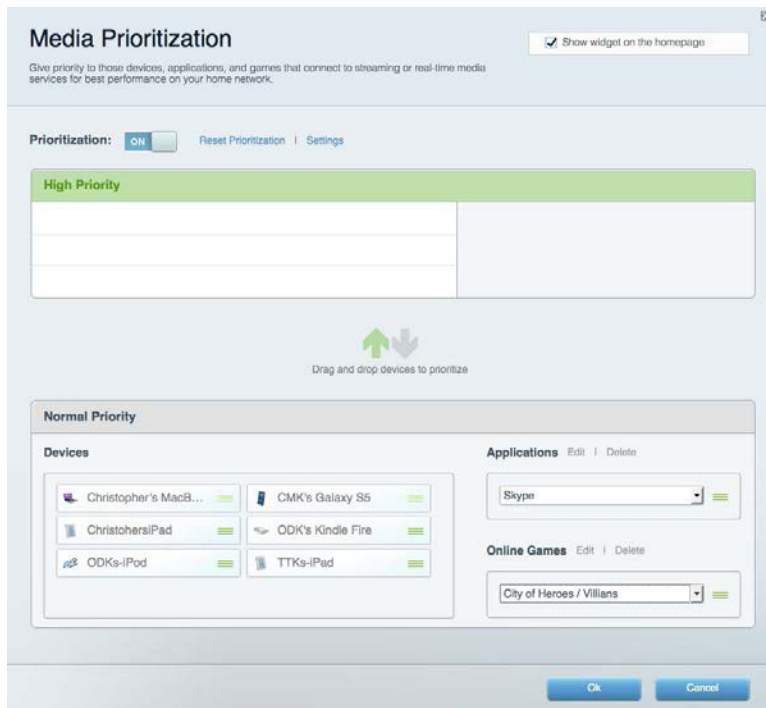

## Teste de velocidade

Permite que você teste a velocidade de conexão à internet da sua rede.



## Armazenamento externo

Permite que você conecte e acesse uma unidade USB (não inclusa) e configure o compartilhamento de arquivo, um servidor de mídia e um acesso FTP.



## Conectividade

Permite que você veja e altere as configurações de rede básicas e avançadas.

The screenshot shows the 'Connectivity' settings page. It has a title bar with a close button. Below the title, there are tabs for 'Basic', 'Internet Settings', 'Local Network', 'Advanced Routing', 'VLAN', and 'Administration'. The 'Basic' tab is selected. The page is divided into several sections: 'Network Name and Password' with fields for 2.4 GHz and 5 GHz network names and passwords; 'Router Password' with a masked password field; 'Router Firmware Update' with a checked 'Automatic' option and a 'Check for Updates' button; 'Time Zone' with a dropdown menu set to '(GMT-05:00) Eastern Time (USA & Canada)' and a checked 'Automatically adjust for Daylight Savings Time' option; and 'Activity Lights' with an 'ON' toggle and a text box. At the bottom, there are 'Ok', 'Cancel', and 'Apply' buttons.

## Resolução de problemas

Permite que você faça o diagnóstico de problemas no seu roteador e verifique o status da rede.

The screenshot shows the 'Troubleshooting' settings page. It has a title bar with a close button. Below the title, there are tabs for 'Status', 'Diagnostics', and 'Logs'. The 'Diagnostics' tab is selected. The page is divided into several sections: 'Ping IPv4' with input fields for IP or host name and number of pings, and a 'Start to Ping' button; 'Trace route' with an input field for IP or host name and a 'Start to Traceroute' button; 'Reboot' with a 'Reboot the router' link; 'Router configuration' with 'Backup' and 'Restore' buttons; 'Router Firmware' with a 'Restore previous firmware' button; 'Internet Address' showing IPv4 and IPv6 addresses with 'Release and Renew' links; and 'Factory reset' with a 'Reset to factory default settings' link. At the bottom, there is an 'Ok' button.

## Sem fio

Permite que você veja e altere a rede sem fio do seu roteador. Você pode alterar os nomes de rede, o modo de segurança, a senha, o filtro de MAC e os dispositivos conectados usando o Wi-Fi Protected Setup™.

The screenshot shows the 'Wireless' settings page. At the top, there is a 'Show widget on the homepage' checkbox which is checked. Below this, there are tabs for 'Wireless', 'MAC Filtering', and 'Wi-Fi Protected Setup'. The 'Smart Connect' section has two radio buttons: '5 GHz band steering' (selected) and 'Off'. Below this, there are two network configuration sections. The first section is for the 2.4 GHz network, with the name 'arachnid' and a 'Network' toggle set to 'ON'. The second section is for the 5 GHz network, with the name 'arachnid\_5GHz' and a 'Network' toggle set to 'ON'. Both sections include fields for 'Password', 'Broadcast SSID', 'Channel', 'Security mode', and 'Network mode'. At the bottom of the page are 'Ok', 'Cancel', and 'Apply' buttons.

## Segurança

Permite que você veja e altere a segurança sem fio do seu roteador. É possível definir o firewall, as configurações da VPN e criar configurações personalizadas para aplicativos e jogos.

The screenshot shows the 'Security' settings page. At the top, there is a 'View and change router settings' link. Below this, there are tabs for 'Firewall', 'DMZ', and 'Apps and Gaming'. The 'Firewall' section is active and contains several sub-sections: 'Firewall' with 'IPv4 SPI firewall protection' and 'IPv6 SPI firewall protection' both checked and 'Enabled'; 'VPN Passthrough' with 'IPSec Passthrough', 'PPTP Passthrough', and 'L2TP Passthrough' all checked and 'Enabled'; and 'Internet filters' with 'Filter anonymous Internet requests' checked, 'Filter multicast' unchecked, 'Filter Internet NAT redirection' unchecked, and 'Filter ident (Port 113)' checked. At the bottom of the page are 'Ok', 'Cancel', and 'Apply' buttons.

# Resolução de problemas

Você pode obter mais ajuda no nosso suporte premiado, em [linksys.com/support/EA8300](http://linksys.com/support/EA8300).

## Seu roteador não foi configurado

Se o Linksys Smart Wi-Fi não concluiu a configuração, pode-se tentar o seguinte:

- Mantenha pressionado o botão Redefinir no seu roteador com um clipe de papel ou alfinete até que o logotipo iluminado da Linksys desligue e os indicadores MU-MIMO na cor azul comecem a piscar (cerca de 10 segundos). Instale o roteador novamente.

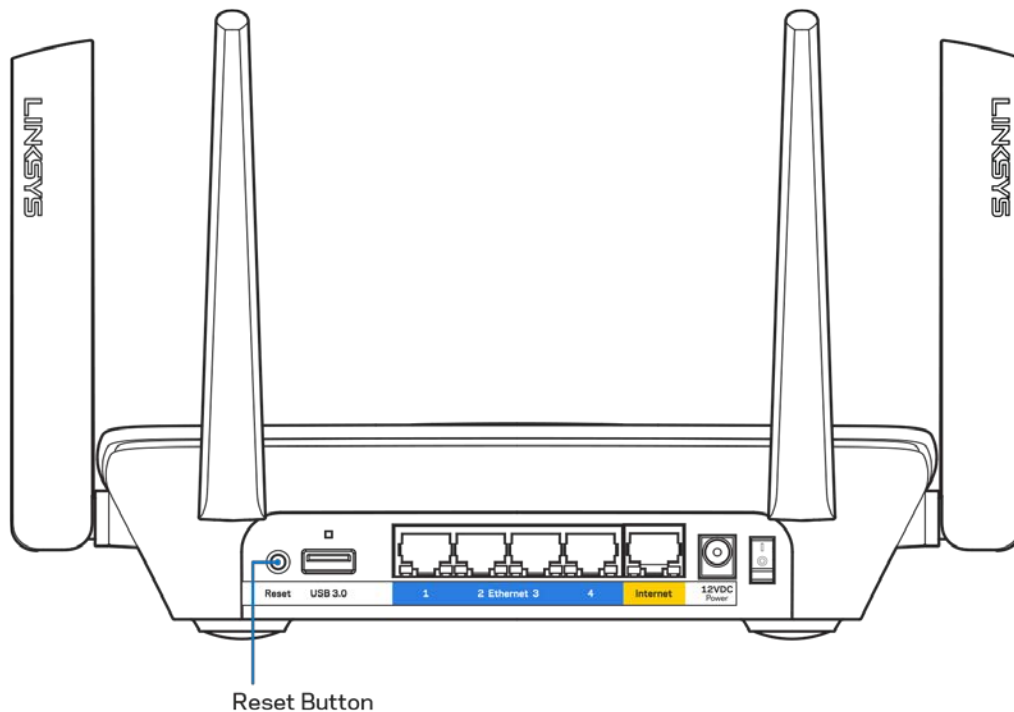

- Desabilite temporariamente o firewall do computador (consulte as instruções de segurança do software para obter ajuda). Instale o roteador novamente.
- Se você tiver outro computador, use-o para instalar o roteador novamente.

## Mensagem *"O cabo de internet não está conectado"*

Se a mensagem "O cabo de Internet não está conectado" for exibida ao tentar configurar o roteador, siga estes passos para resolução de problemas:

- Conecte um cabo Ethernet ou de internet (ou um cabo como o fornecido com o roteador) de forma segura na porta amarela de internet na parte de trás do roteador e na porta correta do seu modem. Essa porta no modem é normalmente rotulada como Ethernet.

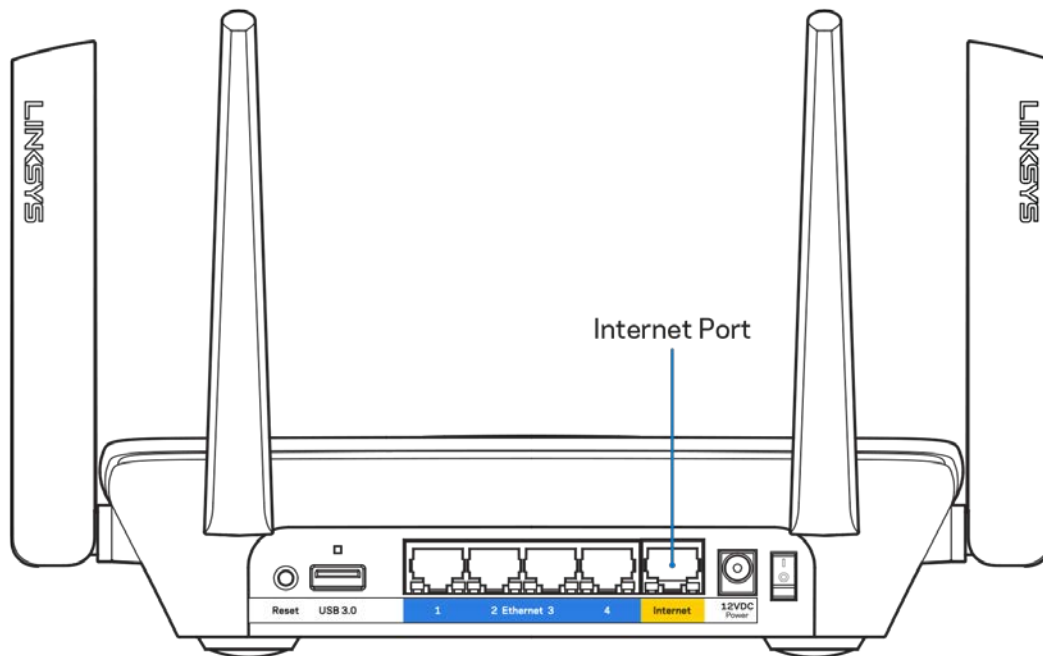

- Verifique se o modem está conectado à energia e ligado. Se houver um interruptor de energia, verifique se está LIGADO ou na posição | (oposto à posição O).

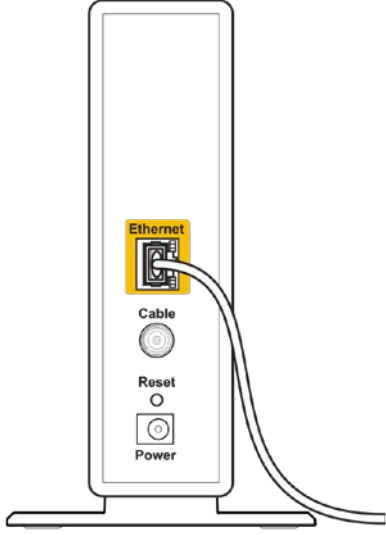
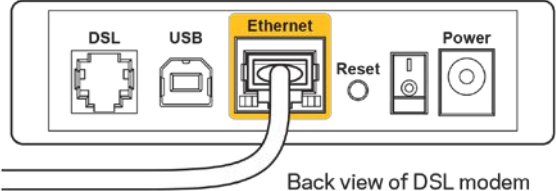

 <p>Back view of cable modem</p>	 <p>Back view of DSL modem</p>
<p>Se o seu serviço de internet é por cabo, verifique se o cabo da porta CABO do modem está conectado ao cabo coaxial fornecido pelo seu provedor de serviços de internet (ISP).</p>	<p>Ou, se o seu serviço de internet for DSL, conecte a linha telefônica do DSL na porta DSL do modem.</p>

- Se o seu computador foi previamente conectado ao seu modem com um cabo USB, desconecte o cabo USB.
- Instale o roteador novamente.

## Mensagem *"Não é possível acessar o roteador"*

Para acessar o roteador, conecte-se à sua rede. Se tiver acesso sem fio à internet, talvez você tenha se conectado acidentalmente a uma rede sem fio diferente.

Para solucionar o problema em computadores com Windows, faça o seguinte\*:

1. Clique no ícone de rede sem fio na bandeja do sistema. É exibida uma lista das redes disponíveis.

2. Clique no seu nome de rede. Clique em Conectar. No exemplo abaixo, o computador estava conectado a outra rede sem fio chamada wraith\_5GHz. O nome da rede sem fio do roteador Linksys EA8300, Damaged\_Beez2.4 neste exemplo, é mostrado selecionado.



3. Se você for solicitado a inserir uma chave de segurança de rede, digite sua senha (chave de segurança) no campo *chave de segurança* da rede. Clique em **OK**.
4. Seu computador se conectará à rede e você poderá acessar o roteador.

*\*Dependendo de sua versão do Windows, pode haver diferenças em palavras ou ícones nessas etapas.*

Para solucionar o problema em computadores Mac, faça o seguinte:

1. Na barra de menus localizada no topo da tela, clique no ícone Wi-Fi. Uma lista de redes sem fio será exibida.
2. No exemplo abaixo, o computador estava conectado a outra rede sem fio chamada wraith\_5GHz. O nome da rede sem fio do roteador Linksys EA8300, Damaged\_Beez2.4 neste exemplo, é mostrado selecionado.

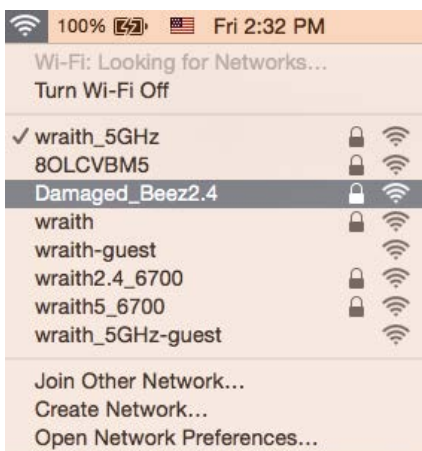

3. Clique no nome da rede sem fio do roteador Linksys EA8300, (Damaged\_Beez2.4 neste exemplo).
4. Digite a senha da sua rede sem fio (chave de segurança) no campo *Senha*. Clique em **OK**.

## Após a configuração

### A internet parece estar indisponível

Se houve dificuldade de comunicação da internet com o roteador, o problema pode aparecer como a mensagem "Não é possível localizar [endereço de internet]" no navegador de internet. Se você sabe que o endereço de internet está correto e se você tentou diversos endereços válidos de internet com o mesmo resultado, a mensagem pode significar que há um problema com seu ISP ou modem se comunicando com o roteador. Tente o seguinte:

- Certifique-se de que os cabos de alimentação e rede estejam firmemente conectados.
- Certifique-se de que a tomada de alimentação à qual seu roteador está conectado tenha energia.
- Reinicie seu roteador.
- Entre em contato com seu ISP e pergunte sobre quedas em sua área.

O método mais comum de solução de problemas em seu roteador é desligá-lo e depois ligá-lo novamente. Seu roteador pode então recarregar suas configurações personalizadas e outros dispositivos (como o modem) poderão redescobrir o roteador e se comunicar com ele. Esse processo é chamado de reinicialização.

Para reiniciar seu roteador usando o cabo de alimentação, faça o seguinte:

1. Desconecte o cabo de alimentação do roteador e o modem.
2. Aguarde 10 segundos e reconecte o cabo de alimentação ao modem. Certifique-se de que haja alimentação.
3. Aguarde até o indicador on-line do modem parar de piscar (cerca de dois minutos). Reconecte o cabo de alimentação ao roteador.
4. Aguarde até que o logotipo iluminado da Linksys esteja aceso. Aguarde dois minutos antes de tentar se conectar à internet pelo computador.

Para reiniciar seu roteador usando o Linksys Smart Wi-Fi, faça o seguinte:

1. Faça login no Linksys Smart Wi-Fi. (Consulte "Como conectar o Linksys Smart Wi-Fi" na página [11](#).)
2. Em *Configurações do roteador*, clique em *Solução de problemas*.
3. Clique na guia *Diagnóstico*.
4. Em *Reiniciar*, clique em Reiniciar.



5. Clique em **Sim**. O roteador será reiniciado. Enquanto o roteador é reiniciado, todos os dispositivos conectados perderão a conexão com a internet e se reconectarão automaticamente quando o roteador estiver pronto novamente.

## O Linksys Smart Wi-Fi não abre em seu navegador de Internet

As versões mais recentes do Google Chrome™, Firefox®, Safari® (para Mac® e iPad®), Microsoft Edge e Internet Explorer® versão 8 e posteriores funcionam com o Linksys Smart Wi-Fi.

# Especificações

## Linksys EA8300

Nome do modelo	Roteador tribanda Max-Stream AC2200 MU-MIMO
Número de modelo	EA8300
Velocidade da porta de switch	10/100/1000 Mbps (Gigabit Ethernet)
Radiofrequência	2.4 GHz e 5 GHz (x2)
Nº de antenas	4 antenas externas ajustáveis (não destacáveis)
Portas	USB 3, Ethernet (1-4), internet, alimentação
Botões	Wi-Fi Protected Setup, alimentação, reiniciar
Luzes	<b>Painel superior:</b> Logotipo iluminado da Linksys , Wi-Fi Protected Setup, conexão à internet, porta de conexão de cabo de rede à internet. <b>Painel traseiro:</b> USB, Ethernet (1-4), internet
UPnP	Suportado
Recursos de segurança	WEP, WPA2, RADIUS
Bits de chave de segurança	Criptografia de até 128 bits
Suporte de sistema de arquivos de armazenamento	FAT, NTFS e HFS+
Suporte no navegador	Versões mais recentes do Google Chrome™, Firefox®, Safari® (para Mac® e iPad®), Microsoft Edge e Internet Explorer® versão 8 ou mais recente

## Informações ambientais

Dimensões	213,7mm x 161,8mm x 54,8mm (sem as antenas)
Peso da unidade	608 g
Alimentação	12V, 2A
Certificações	FCC, IC, CE, Wi-Fi (a/b/g/n/ac)
Temperatura operacional	0 a 40 °C (32 a 104 °F)
Temperatura de armazenamento	-20 a 60 °C (-4 a 140 °F)
Umidade de funcionamento	Umidade relativa de 10 a 80%, sem condensação
Umidade de armazenamento	De 5% a 90%, sem condensação

Especificações sujeitas a alterações sem aviso prévio.

Observações:

Para informações reguladoras, de garantia e segurança, veja o CD que acompanha o roteador ou acesse [Linksys.com/support/EA8300](http://Linksys.com/support/EA8300).

Desempenho máximo derivado das especificações do padrão IEEE 802.11. O desempenho real pode variar, incluindo capacidade de rede sem fio, taxa de transferência de dados, alcance e cobertura inferiores. O desempenho depende de muitos fatores, condições e variáveis, incluindo a distância do ponto de acesso, volume do tráfego da rede, materiais de edificação e construção, sistema operacional usado, combinação de produtos sem fio usados, interferência e outras condições adversas.

BELKIN, LINKSYS e muitos outros nomes de produtos e logotipos são marcas comerciais do grupo de empresas Belkin. As marcas comerciais de terceiros mencionadas são de propriedade de seus respectivos proprietários. Licenças e avisos para os software de terceiros usados neste produto podem ser acessados aqui: <http://support.linksys.com/en-us/license>. Entre em contato com <http://support.linksys.com/en-us/gplcodecenter> em caso de dúvidas ou para solicitar o código fonte da GPL.

© 2017 Belkin International, Inc. e/ou suas afiliadas. Todos os direitos reservados.

**LINKSYS®**

Ghid de utilizare

**ROUTER MAX-STREAM™**  
**AC2200 MU-MIMO**  
**CU TREI BENZI**

Model EA8300

# Cuprins

Prezentare generală a produsului.....	3
Vedere de sus .....	3
Indicator stare sistem .....	4
Vedere din spate .....	5
Vedere laterală .....	6
Instalarea: aspectele de bază .....	7
Unde puteți găsi ajutor suplimentar.....	7
Modul de instalare a routerului.....	8
Modul de utilizare a Linksys Smart Wi-Fi.....	11
Modul de conectare la Linksys Smart Wi-Fi.....	11
Hartă rețea .....	12
Acces invitați .....	12
Funcții de control parental .....	13
Prioritizarea media .....	13
Test de viteză .....	14
Stocare externă .....	14
Conectivitate .....	15
Depanare.....	15
Wireless.....	16
Securitate .....	16
Depanare .....	17
Routerul nu a fost configurat cu succes .....	17
<i>Mesajul Your Internet cable is not plugged in</i> (Cablul dvs. de Internet nu este conectat) .....	18
<i>Mesajul Cannot access your router</i> (Nu se poate accesa routerul) .....	19
După configurare.....	21
Conexiunea la internet pare să nu funcționeze .....	21
Linksys Smart Wi-Fi nu se deschide în browserul web .....	22
Specificații .....	23
Linksys EA8300 .....	23
Cerințe de mediu .....	23



# Prezentare generală a produsului

## Vedere de sus

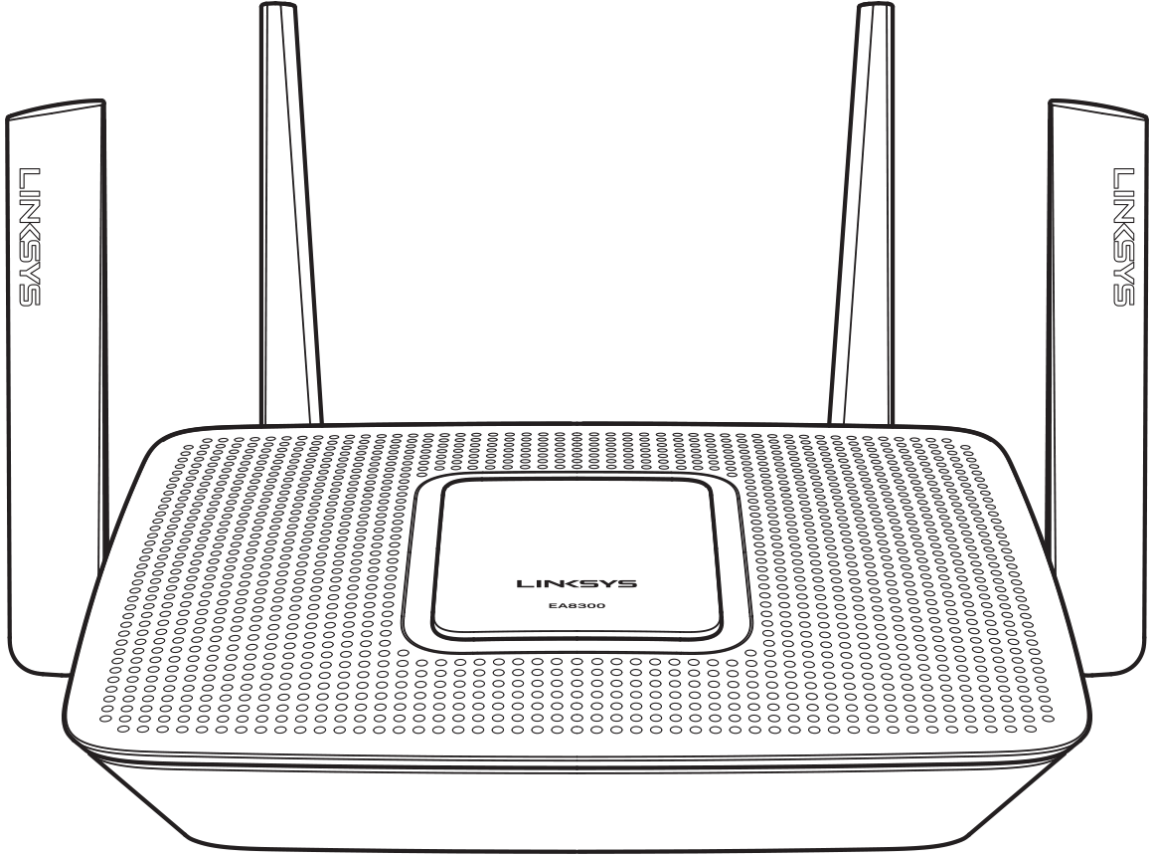

## Indicator stare sistem

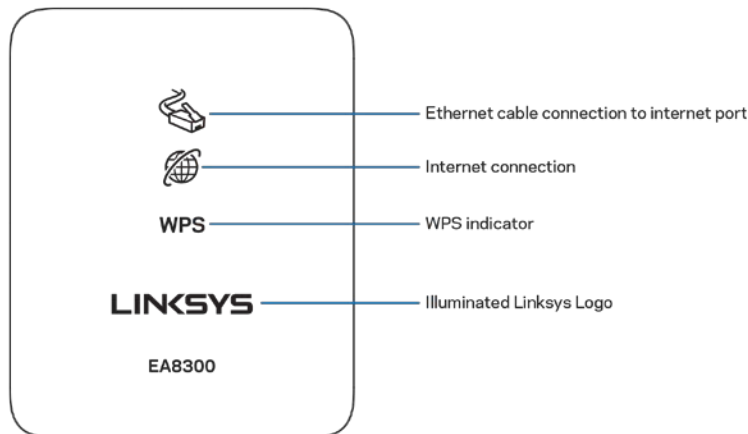

Conexiune prin cablu Ethernet la portul Internet— Când este aprins (portocaliu), indică o problemă legată de cablul de rețea conectat la portul Internet (WAN).

Conexiune la internet— Când este aprins (portocaliu), indică faptul că routerul nu poate accesa internetul.

Indicator WPS (Wi-Fi Protected Setup™) — Indicatorul WPS are patru stări:

Oprit	Nu există activitate Wi-Fi Protected Setup
Alb intermitent	Wi-Fi Protected Setup în curs
Alb continuu	Wi-Fi Protected Setup a fost efectuat cu succes; rămâne aprins timp de cinci secunde
Portocaliu intermitent	Eroare Wi-Fi Protected Setup; se aprinde intermitent un minut, apoi se stinge

Logo Linksys iluminat — Se aprinde intermitent în timpul inițializării routerului. Când logoul este alb continuu, routerul este pornit și funcționează corect.

## Vedere din spate

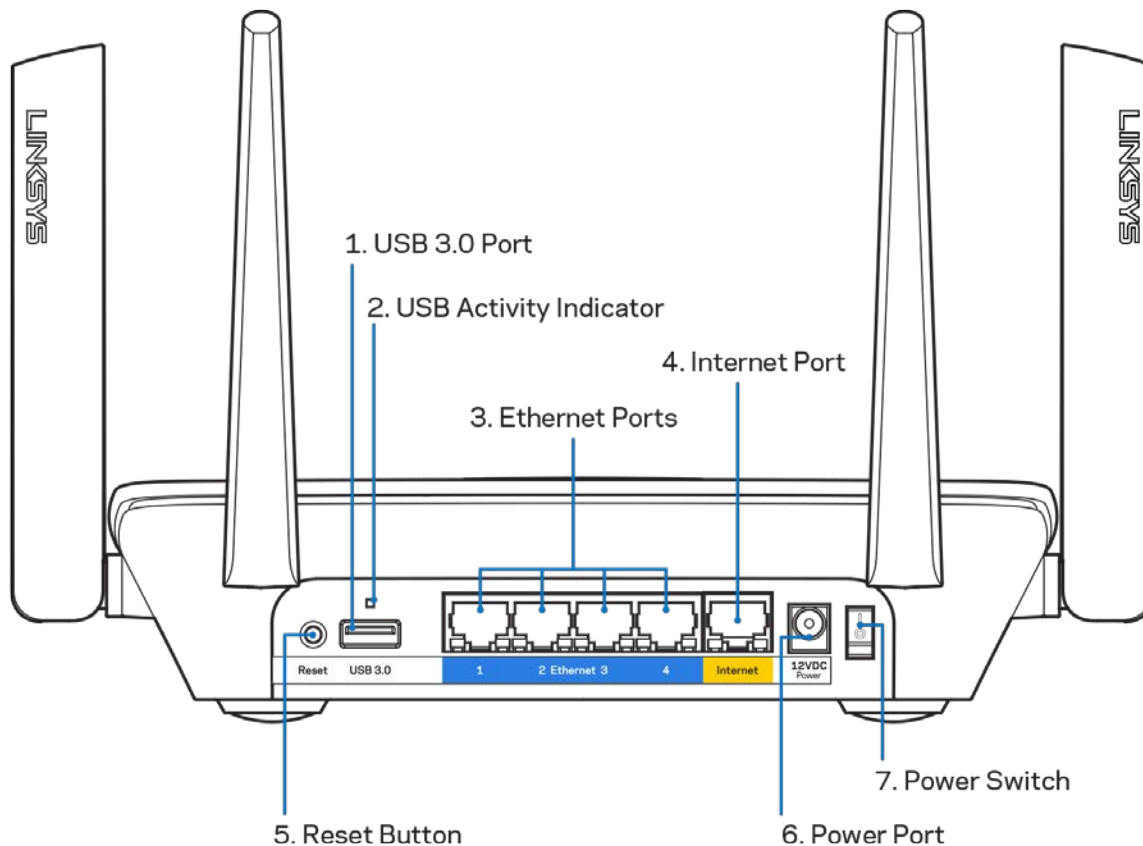

Port USB 3.0 (1) — Conectați și partajați unități USB în rețeaua dvs. sau pe internet.

Indicator activitate USB (2) — Luminile indică transferul de date către/de la dispozitive externe.

Porturile Ethernet (3) — Conectați cablurile ethernet la aceste porturi gigabit albastre (10/100/1000) și la dispozitivele cu cablu din rețeaua dvs.

**Notă**—Pentru o funcționare optimă, la porturile Ethernet utilizați cabluri CAT5e sau de categorie superioară.

Port internet (4) — Conectați un cablu de ethernet la acest port gigabit (10/100/1000) de culoare galbenă și la un cablu de internet broadband/DSL sau un modem pe fibră optică.

**Notă**—Pentru o funcționare optimă, la portul internet utilizați cabluri CAT5e sau de categorie superioară.

Butonul Reset (Resetare) (5) — apăsați continuu până când logoul Linksys iluminat se stinge pentru a reseta routerul la setările implicite din fabrică. De asemenea, puteți restaura setările din fabrică utilizând Linksys Smart Wi-Fi pe internet sau prin aplicația mobilă.

Portul de alimentare (6) — Conectați adaptorul de curent alternativ inclus.

Comutatorul de alimentare (7) — apăsați pe | (pornire) pentru a porni routerul.

## Vedere laterală

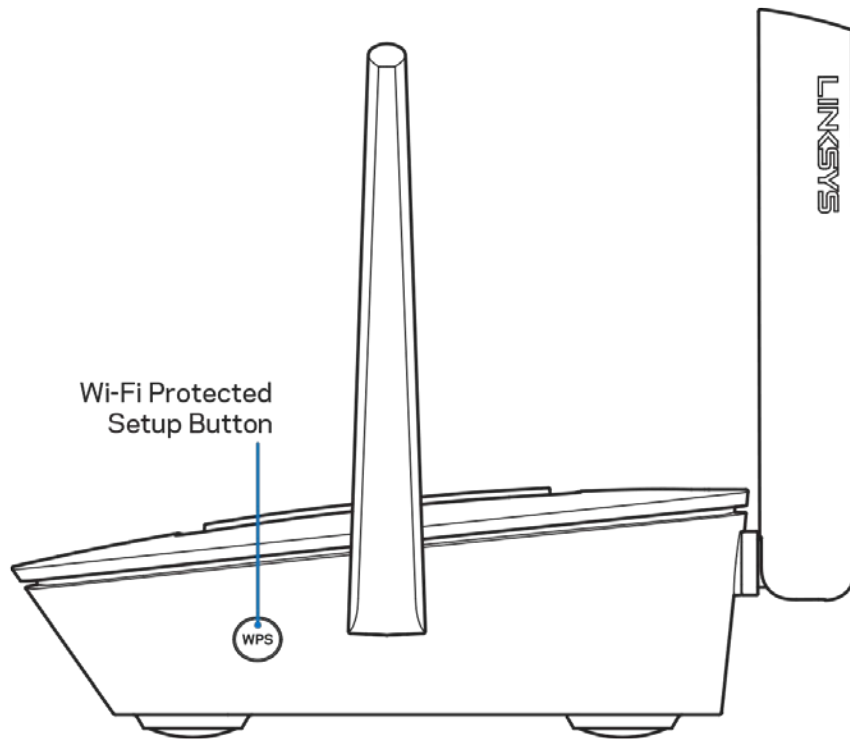

Buton Wi-Fi Protected Setup™ — Apăsați pentru a conecta dispozitive de rețea care au WPS activat.

# Instalarea: aspectele de bază

## Unde puteți găsi ajutor suplimentar

Suplimentar față de acest Ghid de utilizare, puteți găsi asistență la următoarele locații:

- [Linksys.com/support/EA8300](http://Linksys.com/support/EA8300) (documentație, descărcări, întrebări frecvente, asistență tehnică, chat live, forumuri)
- Asistență Linksys Smart Wi-Fi (conectați-vă la Linksys Smart Wi-Fi, apoi efectuați clic pe Asistență în partea de sus a ecranului)

The image shows a screenshot of the Linksys Smart Wi-Fi web interface. At the top, the 'Help' menu item is circled in red. Below the main dashboard, a 'Help' modal window is open, displaying the title 'Using Linksys Smart Wi-Fi' and a list of help categories. The categories listed are: Linksys Smart Wi-Fi, Device List, Guest Access, Parental Controls, Media Prioritization, Speed Test, and External Storage. The 'Linksys Smart Wi-Fi' category is currently selected and highlighted in blue. The main dashboard behind the modal shows various network status widgets, including 'Network Status', 'Linksys Home Networking', 'Wireless', 'Guest Access', 'Network Map', 'Parental Controls', 'External Storage', and 'Media Prioritization'.

Notă—Licențele și notificările pentru software-urile terțe utilizate pentru acest produs pot fi vizualizate la <http://support.linksys.com/en-us/license>. Contactați <http://support.linksys.com/en-us/gplcodecenter> pentru întrebări sau solicitări legate de coduri sursă GPL.

## Modul de instalare a routerului

1. Pentru a finaliza configurarea, veți avea nevoie de un computer pentru a accesa <http://LinksysSmartWiFi.com> într-un browser web.
2. Identificați echipamentul dvs.

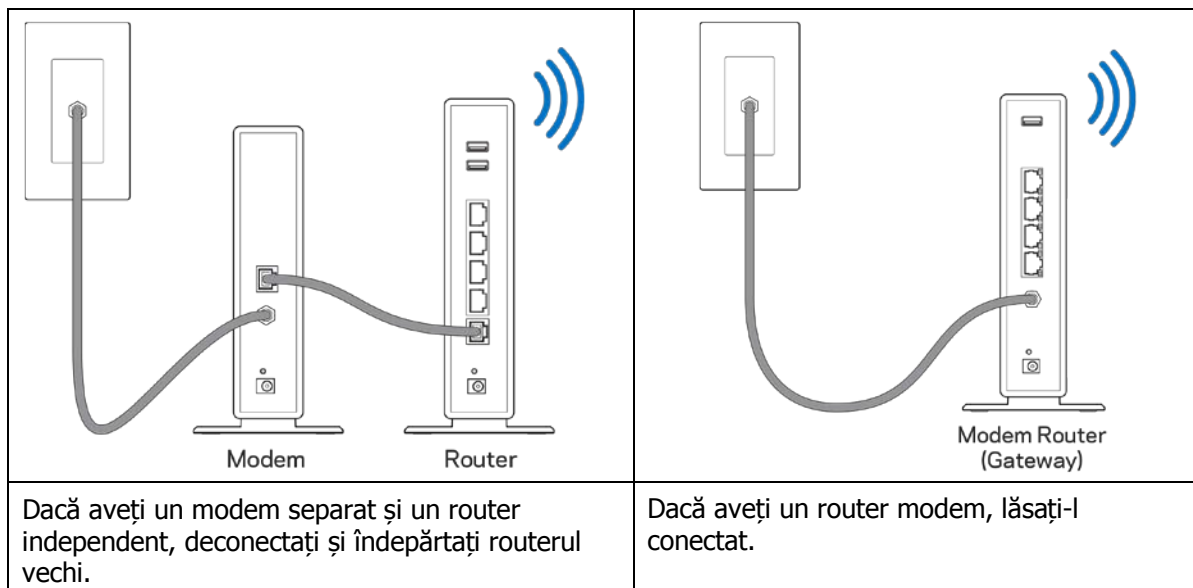

3. Poziționați antenele în sus și conectați routerul la o sursă de alimentare. Asigurați-vă că comutatorul de alimentare este în poziția I (on) (pornit).
4. Conectați routerul la modem sau la routerul modem. Conectați un capăt al cablului de internet inclus la portul de internet de culoare galbenă al noului router. Dacă aveți un modem, conectați celălalt capăt la portul Ethernet (LAN) al modemului. Dacă aveți un router modem, conectați la oricare port disponibil.
5. Așteptați până când logoul Linksys iluminat din partea de sus a routerului încetează să clipească și devine alb continuu.
6. Conectați-vă la numele Wi-Fi prezentat în Ghidul de pornire rapidă furnizat împreună cu routerul. (Puteți modifica aceste detalii mai târziu.) Dacă aveți nevoie de ajutor la conectarea la rețea, consultați documentația dispozitivului la [linksys.com/support/EA8300](http://linksys.com/support/EA8300).

**Notă—nu veți avea acces la internet până la finalizarea configurării routerului.**

7. Introduceți <http://LinksysSmartWiFi.com> într-un browser web. Urmăriți instrucțiunile de pe ecran pentru a finaliza configurarea routerului dumneavoastră. Puteți, de asemenea, tasta 192.168.1.1 într-un browser pentru a porni configurarea.

La finalul instalării, urmați instrucțiunile de pe ecran pentru a vă configura contul Linksys Smart Wi-Fi. Utilizați Linksys Smart Wi-Fi pentru a configura routerul de pe orice computer cu o conexiune la internet.

Gestionați setările routerului:

- Modificarea numelui și a parolei routerului
- Configurarea accesului invitaților
- Configurarea controlului parental
- Conectați dispozitive la rețeaua dvs. Wi-Fi
- Testarea vitezei conexiunii la internet

**Notă**—Ca parte din configurarea contului Linksys Smart Wi-Fi, veți primi un e-mail de verificare. Din rețeaua de domiciliu, efectuați clic pe linkul din e-mail pentru a asocia routerul cu contul Linksys Smart Wi-Fi.

**Recomandare**—Imprimați pagina următoare, apoi înregistrați routerul și setările contului dvs. în tabel ca material de referință. Păstrați informațiile dvs. la loc sigur.

Nume rețea Wi-Fi 2,4 GHz	
Parolă rețea Wi-Fi	
Nume rețea Wi-Fi 5 GHz <sub>1</sub>	
Parolă rețea Wi-Fi	
Nume rețea Wi-Fi 5 GHz <sub>2</sub>	
Parolă rețea Wi-Fi	
Parolă router	
Nume rețea Wi-Fi pentru invitați 2,4 GHz	
Nume rețea Wi-Fi pentru invitați 5 GHz	
Parolă rețea Wi-Fi pentru invitați (Cele două au parolă comună).	
Nume utilizator Linksys Smart Wi-Fi	
Parolă Linksys Smart Wi-Fi	



# Modul de utilizare a Linksys Smart Wi-Fi

Puteți gestiona routerul de oriunde din lume cu ajutorul Linksys Smart Wi-Fi, dar îl puteți gestiona de asemenea în mod direct din rețeaua de domiciliu. Linksys Smart Wi-Fi poate fi de asemenea disponibil și pentru dispozitivul dvs. mobil. Consultați app store-ul dispozitivului dvs. pentru informații.

## Modul de conectare la Linksys Smart Wi-Fi

Pentru conectarea la Linksys Smart Wi-Fi:

1. Deschideți browserul web al computerului.
2. Accesați <http://LinksysSmartWiFi.com> și conectați-vă la contul dvs.

În cazul în care nu vă amintiți parola, faceți clic pe *Forgot your password?* (*Parolă uitată?*) și urmăriți instrucțiunile de pe ecran pentru recuperarea acesteia.

## Hartă rețea

Vă permite să afișați și să gestionați toate dispozitivele dvs. de rețea conectate la router. Puteți vizualiza dispozitivele din rețeaua principală și din rețeaua pentru invitați sau puteți afișa informații despre fiecare dispozitiv.



## Acces invitați

Vă permite să configurați și să monitorizați o rețea pentru ca invitații să poată accesa Wi-Fi fără a fi necesară expunerea informațiilor personale.

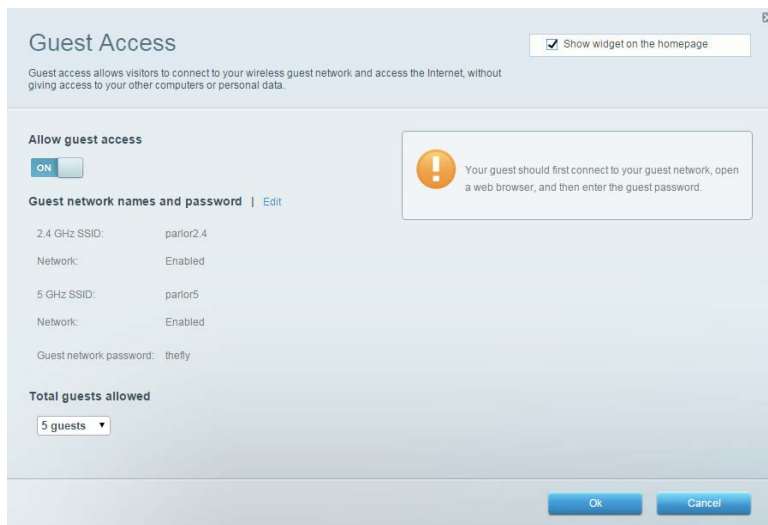

## Funcții de control parental

Vă permit să blocați site-urile web și să setați ore de acces la internet.

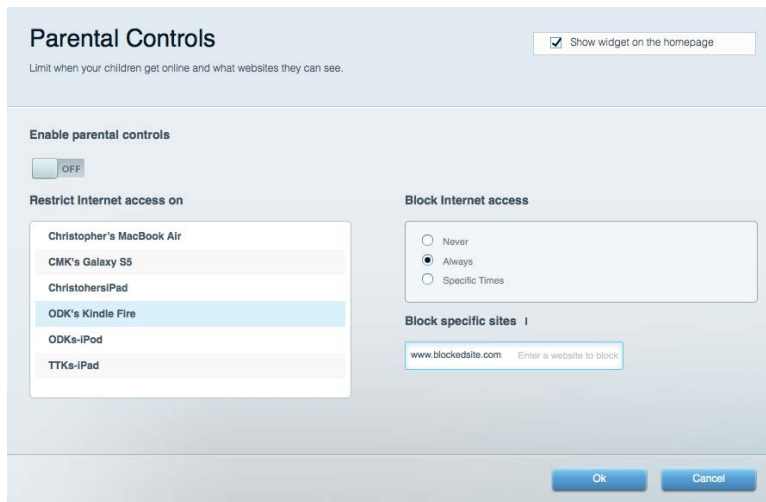

## Prioritizarea media

Vă permite să configurați care dispozitive și aplicații au cea mai mare prioritate pentru traficul de rețea.

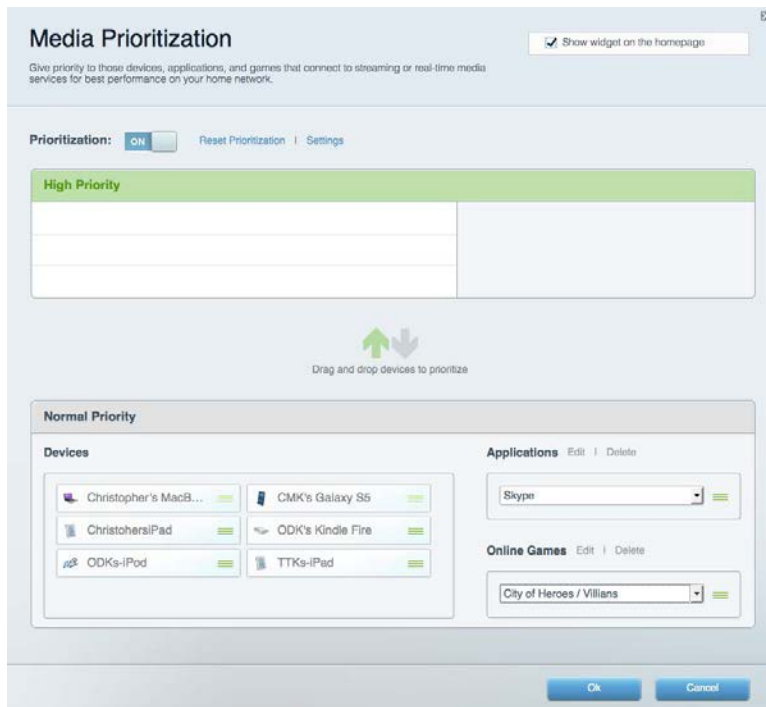

## Test de viteză

Vă permite să testați viteza conexiunii de internet a rețelei dvs.



## Stocare externă

Vă permite să accesați o unitate USB atașată (nu este inclusă) și să configurați o partajare de fișiere, un server media și acces FTP.

The screenshot shows the 'External Storage' configuration page. At the top, there is a checkbox labeled 'Show widget on the homepage' which is checked. Below this is a sub-header 'External Storage Drive' with a progress bar showing 'Space used: 886 MB used of 960 MB total.' and buttons for 'Safely remove drive' and 'Refresh'. To the right, there are three sections: 'Secure Folder Access is OFF' with a note 'Any user can access content via shared folders.' and fields for 'PC access (File explorer): \\192.168.1.1' and 'Mac access (Finder): smb://192.168.1.1'; 'FTP Server is OFF' with a note 'Content is not accessible to any user via FTP.' and a field for 'FTP server: Disabled'; and 'Media Server (DLNA) is ON' with a note 'Media content is accessible to DLNA clients.' and a field for 'DLNA server: EA6050'. An 'Ok' button is located at the bottom right.

## Conectivitate

Vă permite să vizualizați și să modificați setări de rețea de bază și avansate.

The screenshot shows the 'Connectivity' settings page. It features a navigation bar with tabs for 'Basic', 'Internet Settings', 'Local Network', 'Advanced Routing', 'VLAN', and 'Administration'. The 'Basic' tab is selected. The page is divided into several sections: 'Network Name and Password' with fields for 2.4 GHz and 5 GHz network names and passwords; 'Router Password' with a masked password field; 'Router Firmware Update' with a checked 'Automatic' option and a 'Check for Updates' button; 'Time Zone' with a dropdown menu set to '(GMT-05:00) Eastern Time (USA & Canada)' and a checked 'Automatically adjust for Daylight Savings Time' option; and 'Activity Lights' with an 'ON' toggle and a descriptive text box. At the bottom, there are 'Ok', 'Cancel', and 'Apply' buttons.

## Depanare

Vă permite diagnosticarea problemelor cu routerul și verificarea stării rețelei.

The screenshot shows the 'Troubleshooting' settings page. It features a navigation bar with tabs for 'Status', 'Diagnostics', and 'Logs'. The 'Diagnostics' tab is selected. The page is divided into several sections: 'Ping IPv4' with input fields for IP or host name and number of pings, and a 'Start to Ping' button; 'Trace route' with an input field for IP or host name and a 'Start to Traceroute' button; 'Reboot' with a 'Reboot the router' link; 'Router configuration' with 'Backup' and 'Restore' buttons; 'Router Firmware' with a 'Restore previous firmware' button; 'Internet Address' showing IPv4 and IPv6 addresses with 'Release and Renew' links; and 'Factory reset' with a 'Reset to factory default settings' link. At the bottom, there is an 'Ok' button.

## Wireless

Vă permite să vizualizați și să modificați rețeaua wireless a routerului. Puteți modifica numele rețelelor, modul de securitate, parola, filtrarea MAC și puteți conecta dispozitive utilizând Wi-Fi Protected Setup.

The screenshot shows the 'Wireless' settings page. At the top, there is a 'Show widget on the homepage' checkbox which is checked. Below this, there are tabs for 'Wireless', 'MAC Filtering', and 'Wi-Fi Protected Setup'. The 'Smart Connect' section has two radio buttons: '5 GHz band steering' (selected) and 'Off'. Below this, there are two network configuration sections. The first section is for the 2.4 GHz network, with the name 'arachnid', password 'peterparker', and security mode 'WPA2/WPA Mixed Pt'. The second section is for the 5 GHz network, with the name 'arachnid\_5GHz', password 'peterparker', and security mode 'WPA2/WPA Mixed Pt'. At the bottom, there are 'Ok', 'Cancel', and 'Apply' buttons.

## Securitate

Vă permite să vizualizați și să modificați securitatea wireless a routerului. Puteți configura paravanul de protecție, setările VPN și puteți stabili setări personalizate pentru aplicații și jocuri.

The screenshot shows the 'Security' settings page. At the top, there is a 'Show widget on the homepage' checkbox which is checked. Below this, there are tabs for 'Firewall', 'DMZ', and 'Apps and Gaming'. The 'Firewall' section has two checkboxes: 'IPv4 SPI firewall protection' and 'IPv6 SPI firewall protection', both of which are checked. The 'VPN Passthrough' section has three checkboxes: 'IPSec Passthrough', 'PPTP Passthrough', and 'L2TP Passthrough', all of which are checked. The 'Internet filters' section has four checkboxes: 'Filter anonymous Internet requests' (checked), 'Filter multicast' (unchecked), 'Filter Internet NAT redirection' (unchecked), and 'Filter ident (Port 113)' (checked). Below this, there is a table for 'IPv6 Port Services' with columns for 'Description', 'Protocol', 'IPv6 Address', 'Allow', and 'Enabled'. At the bottom, there are 'Ok', 'Cancel', and 'Apply' buttons.

# Depanare

Puteți primi mai multă asistență din partea echipei noastre premiate de asistență tehnică la [linksys.com/support/EA8300](https://linksys.com/support/EA8300).

## Routerul nu a fost configurat cu succes

Dacă Linksys Smart Wi-Fi nu a finalizat configurarea, puteți încerca următoarele:

- Apăsați și mențineți apăsat butonul de resetare al routerului cu o agrafă sau cu un ac de siguranță până ce sigla Linksys nu mai luminează, iar indicatoarele MU-MIMO de culoare albastră încep să lumineze intermitent (aproximativ 10 secunde). Instalați din nou routerul.

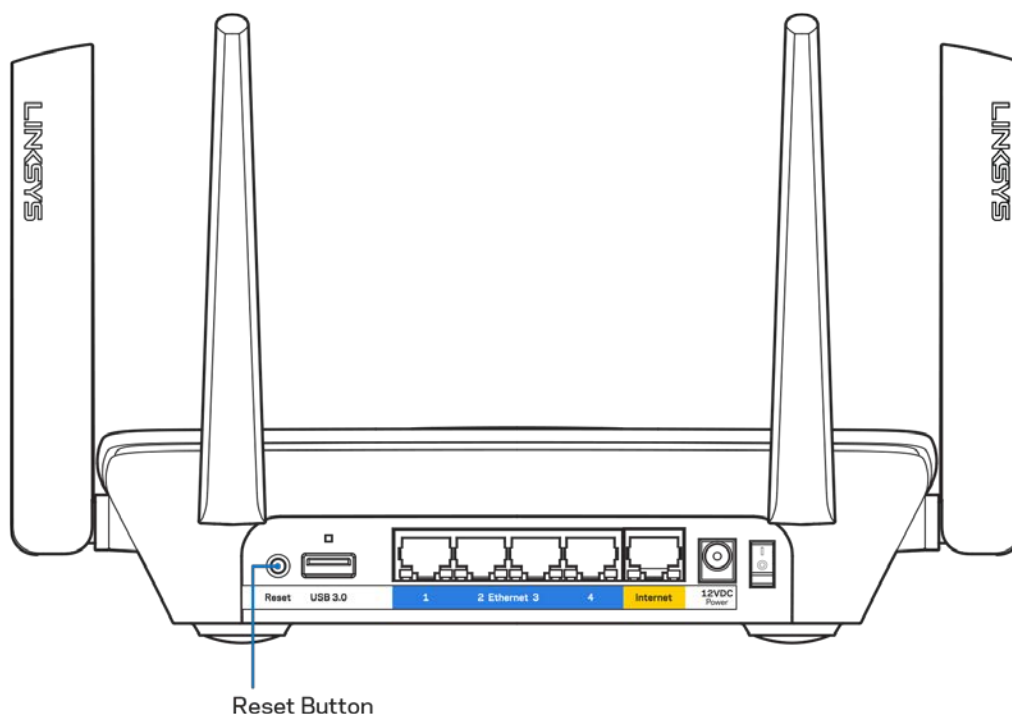

- Dezactivați temporar paravanul de protecție al computerului (consultați instrucțiunile aplicației software de securitate). Instalați din nou routerul.
- Dacă aveți un alt computer, folosiți acel computer pentru a instala din nou routerul.

## Mesajul *Your Internet cable is not plugged in* (Cablul dvs. de Internet nu este conectat)

Dacă primiți mesajul „Cablul de Internet nu este conectat” când încercați să configurați routerul, urmați acești pași de depanare.

- Asigurați-vă că la portul de internet galben de pe partea din spate a routerului și la portul corespunzător de pe modem este conectat ferm un cablu de ethernet sau de internet (sau un cablu precum cel livrat împreună cu routerul). Acest port de pe modem este de obicei etichetat Ethernet.

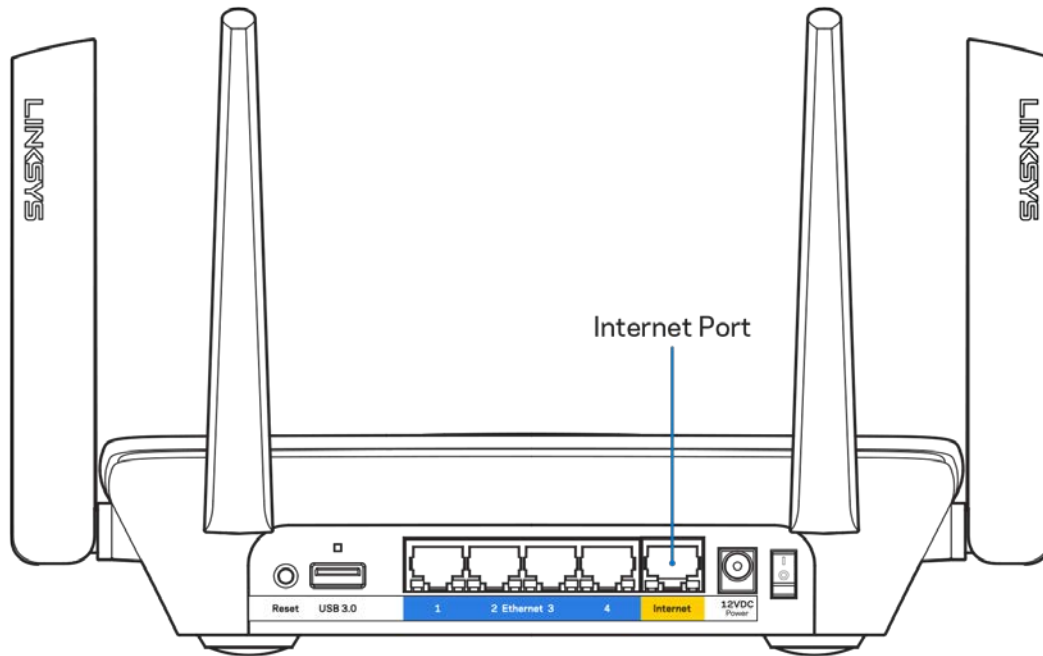

- Asigurați-vă că modemul este conectat la sursa de alimentare și pornit. Dacă acesta este prevăzut cu un comutator de alimentare, asigurați-vă că este în poziția ON (ACTIVAT) sau | (și nu în poziția O).

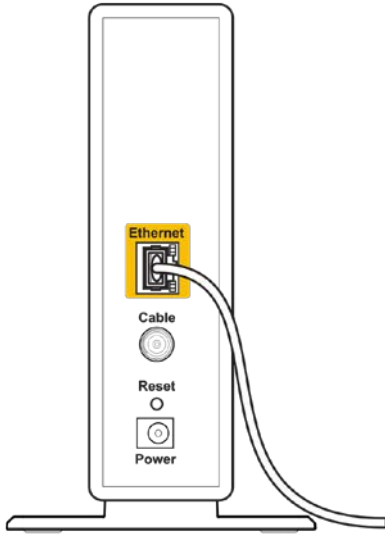
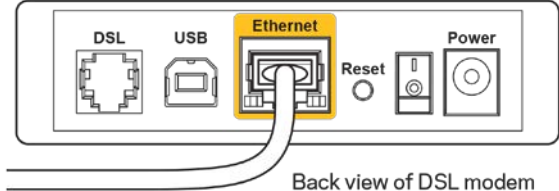

 <p style="text-align: center;">Back view of cable modem</p>	 <p style="text-align: center;">Back view of DSL modem</p>
<p>Dacă serviciul de internet este prin cablu, verificați dacă portul CABLE (CABLU) al modemului cu cablu este conectat la cablul coaxial furnizat de către ISP-ul dvs.</p>	<p>Dacă serviciul de internet este prin DSL, asigurați-vă că linia de telefonie DSL este conectată la portul DSL al modemului.</p>

- În cazul în care computerul dvs. a fost conectat anterior la modem printr-un cablu USB, deconectați cablul USB.
- Instalați din nou routerul.

### *Mesajul Cannot access your router (Nu se poate accesa routerul)*

Pentru a accesa routerul, trebuie să fiți conectat la rețeaua dvs. Dacă aveți acces wireless la internet, problema poate fi faptul că v-ați conectat accidental la o rețea wireless diferită.

Pentru a rezolva problema pe computerele Windows, efectuați următoarele acțiuni\*:

1. Faceți clic pe pictograma wireless din bara de sistem. Apare o listă de rețele disponibile.

2. Faceți clic pe numele rețelei dumneavoastră. Faceți clic pe Conectare. În exemplul de mai jos, computerul era conectat la o altă rețea wireless numită wraith\_5GHz. Numele rețelei wireless a routerului Linksys EA8300, Damaged\_Beez2.4 în acest exemplu, este afișat ca fiind selectat.



3. Dacă vi se solicită să introduceți o cheie de securitate în rețea, introduceți parola (codul de securitate) în câmpul cheii de securitate în rețea. Faceți clic pe OK.
4. Computerul se va conecta la rețea, și veți putea accesa routerul.

\*În funcție de versiunea sistemului de operare Windows, s-ar putea să existe unele diferențe în ceea ce privește denumirile sau pictogramele menționate pentru acești pași.

Pentru a rezolva problema pe computerele Mac, realizați următoarele:

1. În bara de meniu din partea de sus a ecranului, faceți clic pe pictograma Wi-Fi. Apare o listă de rețele wireless.
2. În exemplul de mai jos, computerul era conectat la o altă rețea wireless numită wraith\_5GHz. Numele rețelei wireless a routerului Linksys EA8300, Damaged\_Beez2.4 în acest exemplu, este afișat ca fiind selectat.

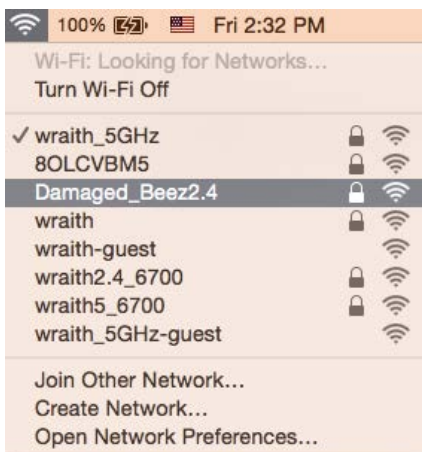

3. Faceți clic pe numele rețelei wireless a routerului Linksys EA8300 (Damaged\_Beez2.4 în exemplu).
4. Introduceți parola rețelei wireless (cheia de securitate) în câmpul Password (parolă). Faceți clic pe OK.

## După configurare

### Conexiunea la internet pare să nu funcționeze

Dacă internetul comunică dificil cu routerul, browserul web poate prezenta mesajul „Cannot find [internet address]” („Nu se poate găsi [Adresă internet]”). În cazul în care știți că adresa internet este corectă și ați primit același mesaj încercând mai multe adrese valide, mesajul poate însemna că există o problemă cu ISP-ul dvs. sau cu modemul care comunică cu routerul. Încercați următoarele:

- Asigurați-vă că sunt bine conectate cablurile de rețea și de alimentare.
- Asigurați-vă că priza de alimentare la care este conectat routerul are alimentare.
- Reinițializați routerul.
- Contactați ISP-ul și întrebați privind eventuale defecțiuni în zona dvs.

Cea mai comună metodă de depanare a routerului este să îl opriți și să îl porniți din nou. Astfel routerul își va reîncărca setările personalizate, iar celelalte dispozitive (precum modem-ul) îl vor redescoperi și vor putea comunica cu acesta. Acest proces este numit rebooting (reinițializare).

Pentru repornirea routerului cu ajutorul cablului de alimentare, efectuați următoarele acțiuni:

1. Deconectați cablul de alimentare de la router și modem.
2. Așteptați 10 secunde, și reconectați cablul de alimentare la modem. Asigurați-vă că acesta are alimentare.
3. Așteptați până când indicatorul privind starea online al modemului încetează să lumineze intermitent (aproximativ două minute). Reconectați cablul de alimentare la router.
4. Așteptați până se aprinde sigla Linksys. Așteptați două minute înainte de a încerca să vă conectați la internet folosind computerul.

Pentru repornirea routerului cu ajutorul Linksys Smart Wi-Fi, efectuați următoarele acțiuni:

1. Conectați-vă la Linksys Smart Wi-Fi. (Consultați „Modul de conectare la Linksys Smart Wi-Fi” de la pagina [11](#).)
2. În *Router Settings (Setări router)*, efectuați clic pe *Troubleshooting (Depanare)*.
3. Efectuați clic pe fila *Diagnostics (Diagnostic)*.
4. Din *Reboot (Reinițializare)*, efectuați clic pe **Reboot (Reinițializare)**.



5. Faceți clic pe Yes (Da). Routerul se va reinițializa. În timp ce routerul se reinițializează, toate dispozitivele conectate își vor pierde conexiunea la internet și se vor reconecta în mod automat atunci când routerul este din nou pregătit.

## Linksys Smart Wi-Fi nu se deschide în browserul web

Cele mai recente versiuni ale Google Chrome™, Firefox®, Safari® (pentru Mac® și iPad®), Microsoft Edge și Internet Explorer® versiunea 8 și versiunile mai recente funcționează cu Linksys Smart Wi-Fi.

# Specificații

## Linksys EA8300

Nume model	Router Max-Stream AC2200 MU-MIMO cu trei benzi
Număr model	EA8300
Viteză port switch	10/100/1000 Mbps (Gigabit Ethernet)
Frecvență radio	2,4 GHz și 5 GHz (x2)
Nr. de antene	4 antene externe ajustabile (nedetașabile)
Porturi	USB 3.0, Ethernet (1-4), Internet, port de alimentare
Butoane	Wi-Fi Protected Setup, buton de alimentare, buton de resetare
Lumini	Panou superior: Logo Linksys iluminat, Wi-Fi Protected Setup, conexiune la internet, Conexiune prin cablu de rețea la portul internet Panoul posterior: USB, Ethernet (1-4), Internet
UPnP	Suportat
Caracteristici de securitate	WEP, WPA2, RADIUS
Octeți cheie securitate	Încryptare până la 128 biți
Asistență pentru sistemul de fișiere de stocare	FAT, NTFS și HFS+
Suport browser	Cele mai recente versiuni ale Google Chrome™, Firefox®, Safari® (pentru Mac® și iPad®), Microsoft Edge și Internet Explorer® versiunea 8 și versiuni mai recente

## Cerințe de mediu

Dimensiuni	213,7mm x 161,8mm x 54,8mm (fără antene)
Greutate unitate	608 g
Alimentare	12V, 2A
Certificări	FCC, IC, CE, Wi-Fi (a/b/g/n/ac)
Temperatură de funcționare	0 - 40°C (32 - 104°F)
Temperatură de depozitare	-20 - 60°C (-4 - 140°F)
Umiditate operațională	între 10% și 80% umiditate relativă, fără condens
Umiditate spațiu de stocare	5%-90%, fără condensare

Specificațiile pot fi modificate fără notificare prealabilă.

Note:

Pentru informații privind reglementările, garanția și securitatea, consultați CD-ul furnizat împreună cu routerul sau accesați [Linksys.com/support/EA8300](http://Linksys.com/support/EA8300).

Performanță maximă asigurată de specificațiile standardului IEEE 802.11. Performanțele reale pot fi diferite, inclusiv capacitatea de rețea wireless inferioară, frecvența de comunicare a datelor, distanța activă și acoperirea. Performanța depinde de numeroși factori, condiții și variabile, inclusiv distanța față de punctul de acces, volumul traficului în rețea, materialele de construcție a clădirii, sistemul de operare utilizat, combinația produselor wireless, interferența și alte condiții nefavorabile.

BELKIN, LINKSYS și multe denumiri de produse și logo-uri sunt mărci comerciale ale grupului de companii Belkin. Mărcile comerciale ale terților menționate aparțin proprietarilor respectivi. Licențele și notificările pentru software-urile terțe utilizate pentru acest produs pot fi vizualizate aici: <http://support.linksys.com/en-us/license>. Contactați <http://support.linksys.com/en-us/gplcodecenter> pentru întrebări sau solicitări legate de coduri sursă GPL.

© 2017 Belkin International, Inc. și/sau părțile sale afiliate. Toate drepturile rezervate.

**LINKSYS®**

Руководство пользователя

**Трёхдиапазонный  
маршрутизатор**

**Max-Stream**

**AC2200 MU-MIMO**

Модель EA8300

# Содержание

Обзор продукта.....	3
Вид сверху .....	3
Индикатор состояния системы.....	4
Вид сзади.....	5
Вид сбоку.....	6
Установка: основы .....	7
Куда обратиться за дополнительной информацией.....	7
Как настроить маршрутизатор.....	8
Как пользоваться Linksys Smart Wi-Fi .....	11
Подключение к Linksys Smart Wi-Fi.....	11
Карта сети.....	12
Гостевой доступ .....	12
Родительский контроль .....	13
Назначение приоритетов .....	13
Проверка скорости .....	14
Внешнее устройство хранения данных.....	14
Подключения .....	15
Поиск и устранение неисправностей.....	15
Беспроводная сеть.....	16
Безопасность.....	16
Поиск и устранение неисправностей.....	17
Маршрутизатор не был успешно установлен.....	17
<i>Сообщение «Кабель Интернета не подключен»</i> .....	18
<i>Сообщение «Маршрутизатор недоступен»</i> .....	19
После настройки .....	21
Интернет по-прежнему недоступен .....	21
Linksys Smart Wi-Fi не открывается в браузере.....	22
Технические характеристики.....	23
Linksys EA8300 .....	23
Физические характеристики.....	23



# Обзор продукта

## Вид сверху

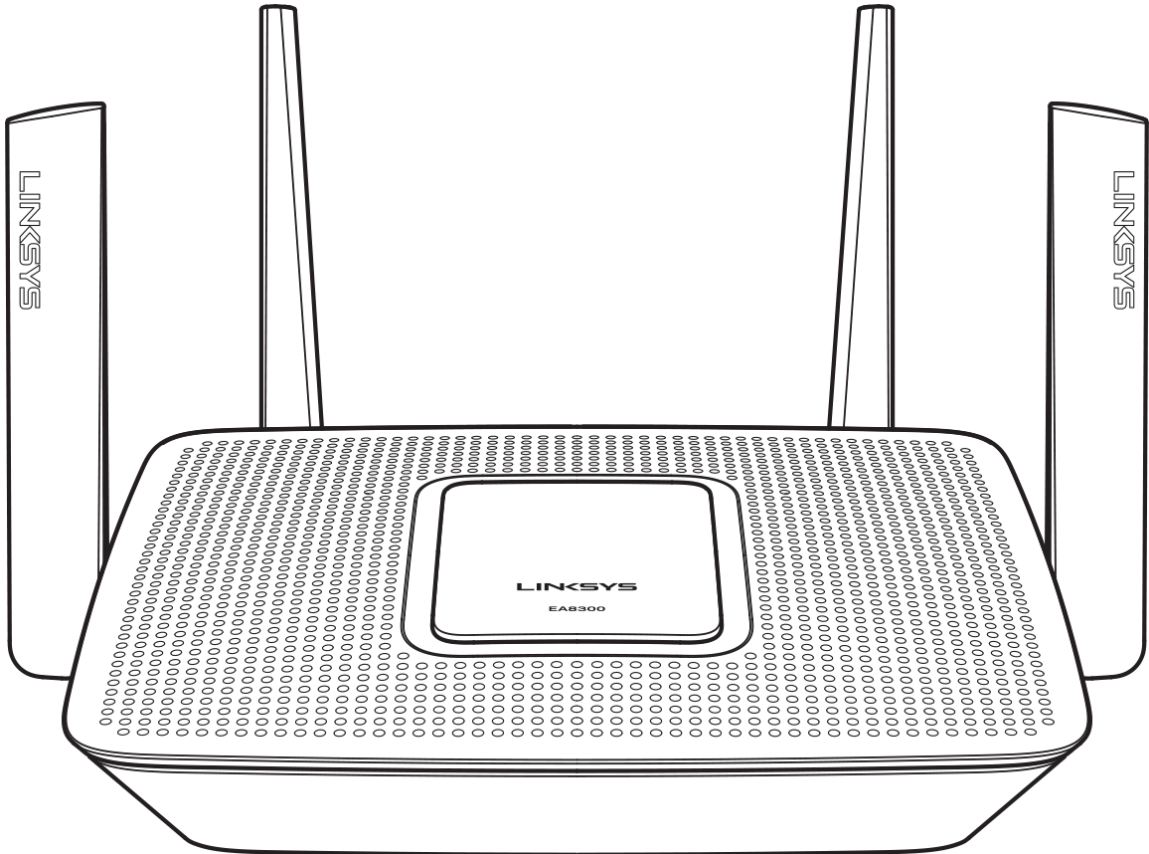

## Индикатор состояния системы

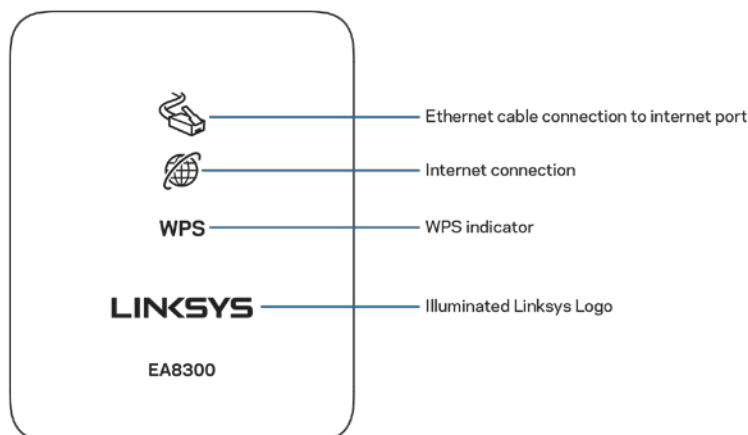

**Подключение кабеля Ethernet к порту Интернета** — когда этот индикатор горит (оранжевым цветом), это указывает на неполадки сетевого кабеля, подключенного к порту Интернета (WAN).

**Подключение к Интернету** — когда этот индикатор горит (оранжевым цветом), это указывает, что маршрутизатору не удастся получить доступ к Интернету.

**Индикатор WPS (Wi-Fi Protected Setup™)** — у индикатора WPS четыре возможных состояния:

<b>Выключен</b>	Wi-Fi Protected Setup не используется
<b>Мигает белым цветом</b>	Идет настройка Wi-Fi Protected Setup
<b>Горит белым цветом</b>	Настройка Wi-Fi Protected Setup успешно завершена, индикатор будет гореть в течение пяти секунд
<b>Мигает оранжевым цветом</b>	Ошибка Wi-Fi Protected Setup, индикатор будет мигать в течение одной минуты, затем погаснет

**Подсвеченная эмблема Linksys** — мигает при запуске маршрутизатора. Когда эта эмблема непрерывно горит белым цветом, маршрутизатор включен и правильно работает.

## Вид сзади

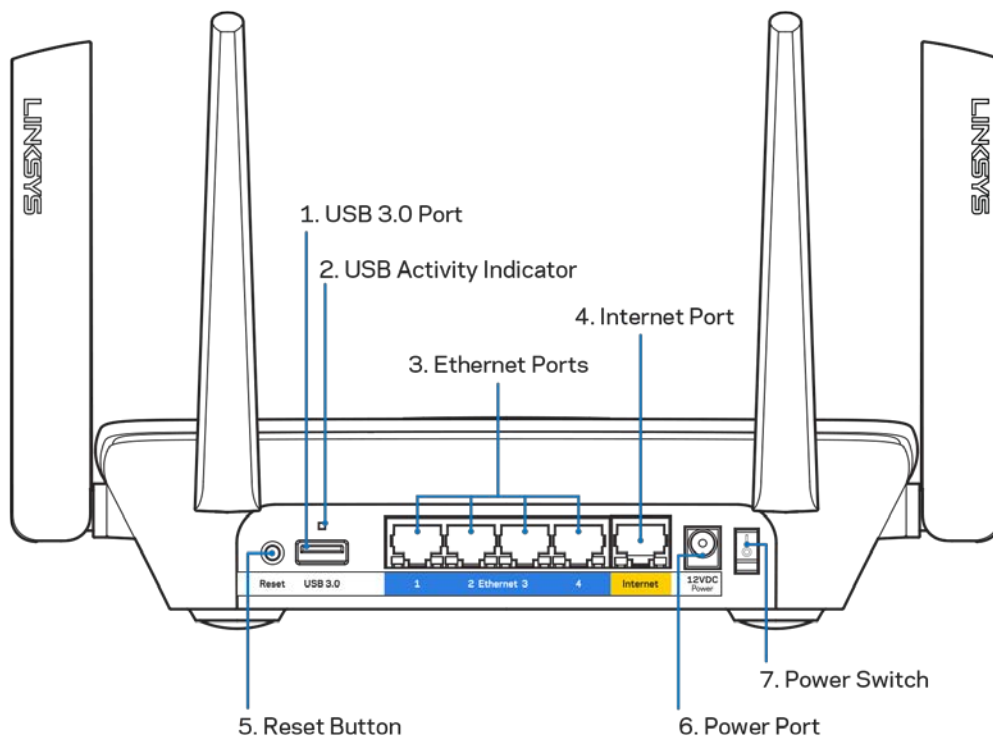

**Порт USB 3.0 (1)** — предназначен для подключения USB-накопителей, чтобы предоставить доступ к ним в пределах вашей сети и в Интернете.

**Индикатор USB (2)** — указывает передачу данных на внешние устройства или прием данных с внешних устройств.

**Порты Ethernet (3)**— подключите кабели Ethernet к этим синим гигабитным портам (10/100/1000 Мбит/с) и к проводным устройствам в вашей сети.

*Примечание. Для лучшей производительности используйте кабели категории 5е или более высокой категории для портов Ethernet.*

**Порт Интернета (4)** — подключите кабель Ethernet к этому желтому гигабитному порту (10/100/1000 Мбит/с) и к широкополосному кабельному модему, DSL или оптоволоконному модему.

*Примечание. Для лучшей производительности используйте кабели категории 5е или более высокой категории для порта Интернета.*

**Кнопка сброса (5)** — нажмите и удерживайте ее до тех пор, пока эмблема Linksys не погаснет, чтобы перезапустить маршрутизатор и восстановить заводские настройки. Также можно восстановить фабричные настройки с помощью страницы Linksys Smart Wi-Fi в Интернете или с помощью мобильного приложения.

**Разъем питания (6)** — подключите к этому разъему адаптер питания, входящий в комплект.

**Выключатель питания (7)** — нажмите | (Вкл.), чтобы включить маршрутизатор.

## Вид сбоку

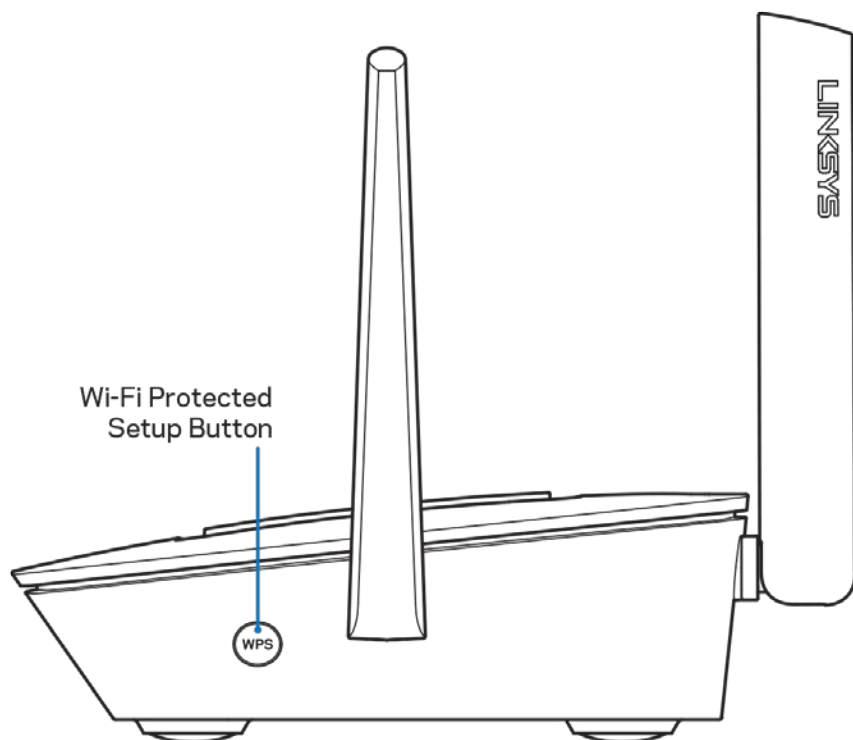

**Кнопка Wi-Fi Protected Setup™** — нажмите для подключения к сетевым устройствам, поддерживающим WPS.

# Установка: основы

## Куда обратиться за дополнительной информацией

В дополнение к этому руководству пользователя можно найти полезную информацию здесь:

- [Linksys.com/support/EA8300](http://Linksys.com/support/EA8300) (документация, загрузки, вопросы и ответы, техническая поддержка, чат, форумы)
- Справка Linksys Smart Wi-Fi (установите подключение к Linksys Smart Wi-Fi, а затем щелкните «Справка» в верхней части экрана)

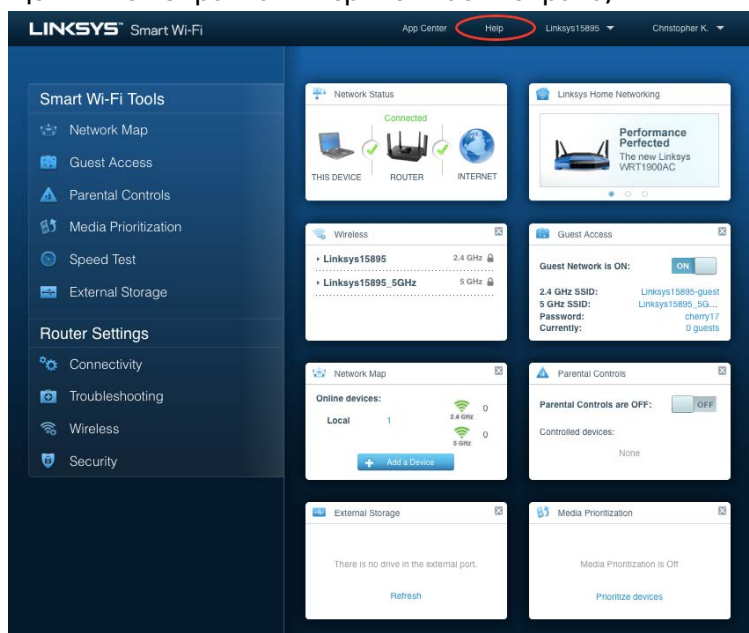

The screenshot shows the Linksys Smart Wi-Fi web interface. The top navigation bar includes 'App Center', 'Help' (highlighted with a red circle), 'Linksys15895', and 'Christopher K.'. The main dashboard displays various network status and settings widgets. A 'Help' dialog box is open at the bottom, showing the 'Using Linksys Smart Wi-Fi' section and a 'Help Categories' list.

**Using Linksys Smart Wi-Fi**

Linksys Smart Wi-Fi allows you to access all of your router's features and settings. Simply click on a feature or widget you want to open.

You can use Linksys Smart Wi-Fi to:

- See what's currently connected to your network, and connect more computers and devices.
- Create a Linksys Smart Wi-Fi account to access router settings from anywhere using any browser, even when you're away from home. You can personalize your router and change settings for wireless access, Internet, gaming, local network, and more. You can even access router settings for multiple routers, which is helpful if you set up and manage more than one router. (The account is available only on EA-Series routers.)
- Allow guests in your home to use the Internet without giving them access to your network. While on the guest network, users can surf the net, but won't be able to access your printers, other computers, or devices on your network.

**Help Categories**

- Linksys Smart Wi-Fi
- Device List
- Guest Access
- Parental Controls
- Media Prioritization
- Speed Test
- External Storage
- Connectivity

Ok

**Примечание.** Лицензии и уведомления для стороннего программного обеспечения, использованного в этом продукте, можно просмотреть по адресу <http://support.linksys.com/en-us/license>. Обращайтесь по адресу <http://support.linksys.com/en-us/gplcodecenter> с вопросами или запросами относительно исходного кода GPL.

## Как настроить маршрутизатор

1. Для настройки потребуется компьютер, чтобы открыть сайт <http://LinksysSmartWiFi.com> в веб-браузере.
2. Опознайте свое оборудование.

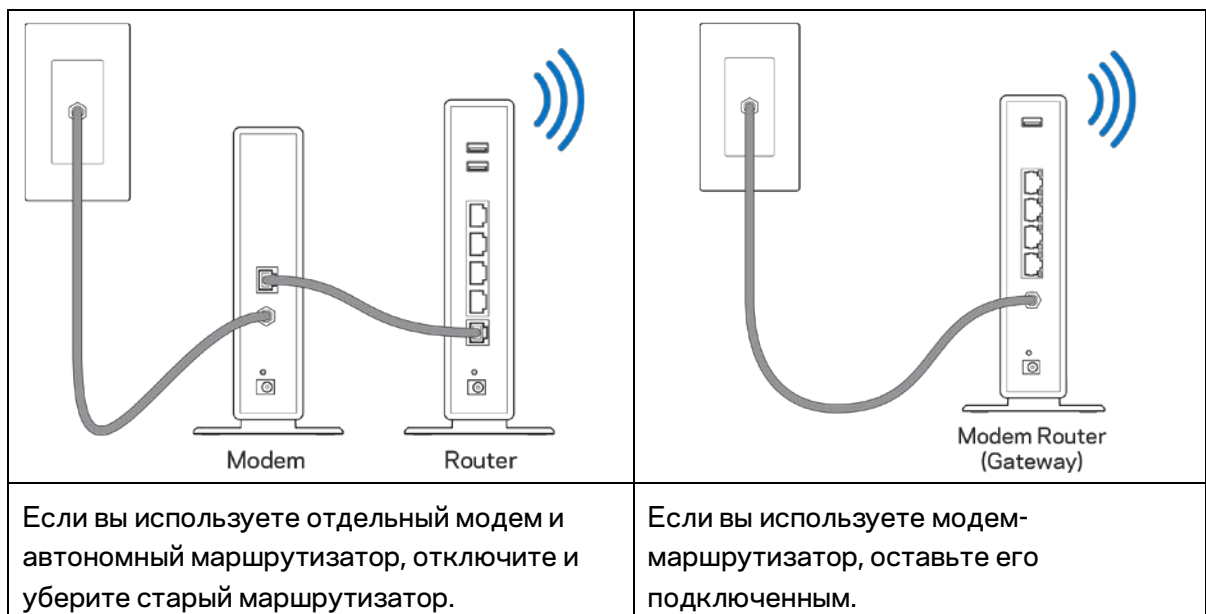

3. Направьте антенны вверх и подключите маршрутизатор к розетке электросети. Убедитесь, что выключатель питания включен.
4. Подключите маршрутизатор к модему (или к модему-маршрутизатору). Подключите один разъем кабеля Интернета, входящего в комплект поставки, в желтый порт Интернета на новом маршрутизаторе. Если вы используете модем, подключите другой разъем этого кабеля в порт Ethernet (LAN) модема. Если вы используете модем-маршрутизатор, подключите другой разъем кабеля в любой свободный порт.
5. Дождитесь, пока подсвеченная эмблема Linksys на верхней части маршрутизатора перестанет мигать и загорится непрерывным белым цветом.
6. Установите подключение к сети Wi-Fi, имя которой указано в руководстве по быстрому запуску, входящему в комплект поставки маршрутизатора. (Эти данные можно изменить позднее.) Если для подключения к сети требуется помощь, см. документацию к вашему устройству, доступную по адресу [linksys.com/support/EA8300](http://linksys.com/support/EA8300).

**Примечание.** Доступ к Интернету появится только после завершения настройки маршрутизатора.

7. В веб-браузере перейдите по адресу <http://LinksysSmartWiFi.com>. Следуйте указанным на экране инструкциям, чтобы настроить маршрутизатор. Также можно ввести адрес 192.168.1.1 в адресной строке браузера, чтобы приступить к настройке.

После завершения настройки создайте учетную запись Linksys Smart Wi-Fi, следуя инструкциям на экране. Используйте учетную запись Linksys Smart Wi-Fi для настройки маршрутизатора с любого компьютера, подключенного к Интернету.

Управление настройками маршрутизатора:

- Изменять имя и пароль маршрутизатора
- Настройка гостевого доступа
- Настройка родительского контроля
- Подключение устройств к сети Wi-Fi
- Проверка скорости подключения к Интернету

**Примечание.** При настройке учетной записи Linksys Smart Wi-Fi вам будет отправлено электронное письмо для подтверждения. Из домашней сети перейдите по ссылке в электронном письме, чтобы связать маршрутизатор с учетной записью Linksys Smart Wi-Fi.

**Совет.** Напечатайте следующую страницу, затем запишите в таблице настройки маршрутизатора и учетной записи, чтобы сохранить их для справки. Храните записи в надежном месте.

Имя сети Wi-Fi 2,4 ГГц	
Пароль Wi-Fi	
Имя сети Wi-Fi 5 ГГц <sub>1</sub>	
Пароль Wi-Fi	
Имя сети Wi-Fi 5 ГГц <sub>2</sub>	
Пароль Wi-Fi	
Пароль маршрутизатора	
Имя гостевой сети Wi-Fi 2,4 ГГц	
Имя гостевой сети Wi-Fi 5 ГГц	
Пароль гостевой сети Wi-Fi (одинаковый в обеих гостевых сетях)	
Имя пользователя Linksys Smart Wi-Fi	
Пароль Linksys Smart Wi-Fi	



# Как пользоваться Linksys Smart Wi-Fi

Можно управлять маршрутизатором из любой точки мира с помощью Linksys Smart Wi-Fi. Это также можно делать и непосредственно из домашней сети. Также возможен доступ к Linksys Smart Wi-Fi с мобильных устройств. См. информацию в магазине приложений для вашего устройства.

## Подключение к Linksys Smart Wi-Fi

Чтобы установить подключение к Linksys Smart Wi-Fi:

1. Откройте браузер на компьютере.
2. Откройте <http://LinksysSmartWiFi.com> и войдите в свою учетную запись.

Если вы забыли пароль, нажмите *Forgot your password?* (Забыли пароль?) и следуйте инструкциям на экране, чтобы восстановить его.

## Карта сети

Позволяет просматривать все сетевые устройства, подключенные к маршрутизатору, а также управлять этими устройствами. Можно просматривать устройства в основной сети и в гостевой сети, отключать устройства и отображать информацию о каждом из них.



## Гостевой доступ

Настройка и отслеживание сети для гостей, чтобы предоставить им доступ к сети Wi-Fi, не предоставляя доступа к личной информации.

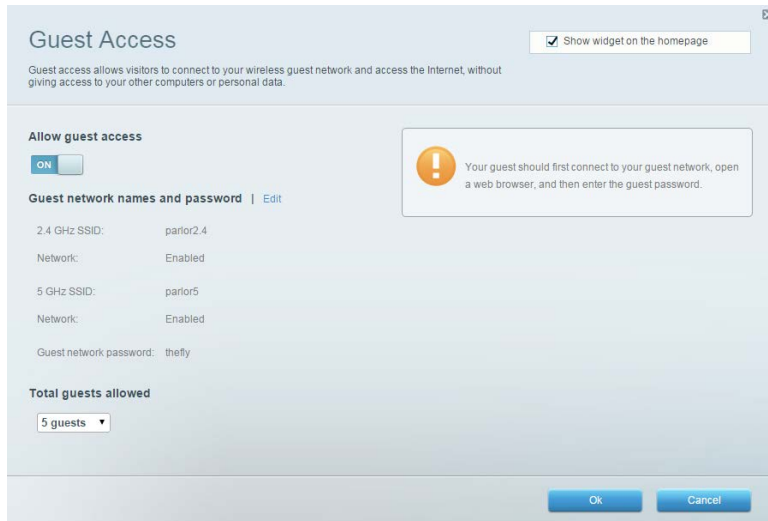

## Родительский контроль

Блокирование определенных веб-сайтов и ограничение времени доступа к Интернету.

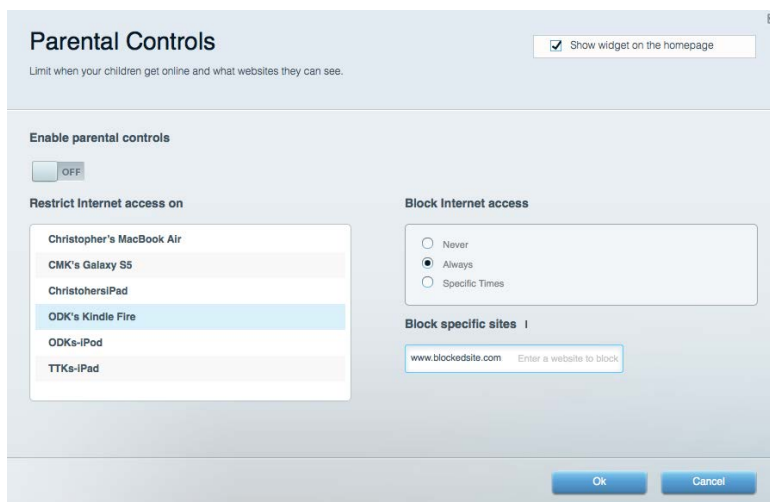

## Назначение приоритетов

Выбор устройств и приложений, которые будут пользоваться сетевым трафиком на приоритетных условиях.

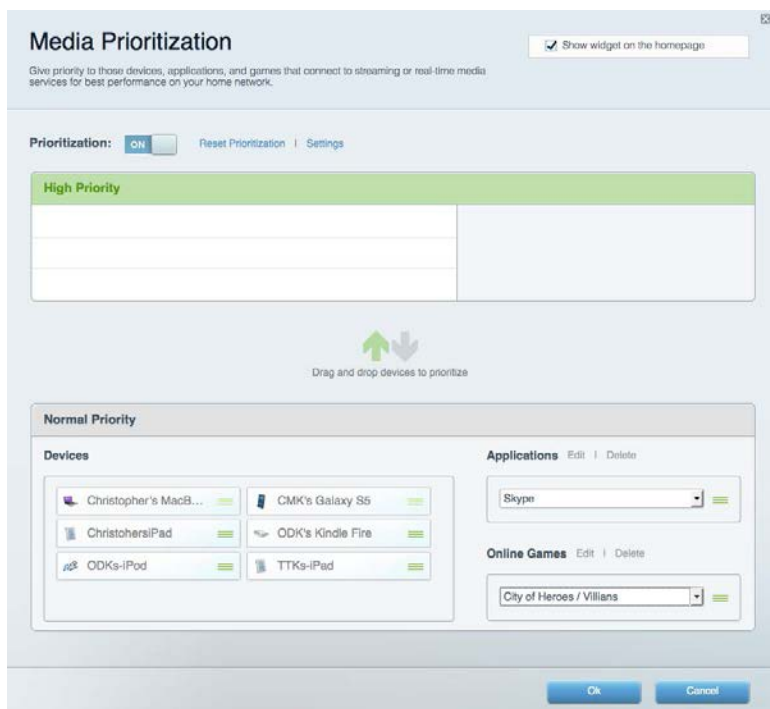

## Проверка скорости

Проверка скорости подключения к Интернету.



## Внешнее устройство хранения данных

Позволяет использовать USB-накопители (приобретается отдельно) и устанавливать медиасервер, организовать общий доступ к файлам, а также доступ к FTP.



## Подключения

Просмотр и изменение основных и расширенных настроек сети.

The screenshot shows the 'Connectivity' settings page. It has a title bar with a close button. Below the title is a subtitle 'View and change router settings'. There are several tabs: 'Basic', 'Internet Settings', 'Local Network', 'Advanced Routing', 'VLAN', and 'Administration'. The 'Basic' tab is selected. The page is divided into several sections: 'Network Name and Password' with fields for 2.4 GHz and 5 GHz network names and passwords; 'Router Password' with a password field; 'Router Firmware Update' with a checked 'Automatic' checkbox and a 'Check for Updates' button; 'Time Zone' with a dropdown menu set to '(GMT-05:00) Eastern Time (USA & Canada)' and a checked 'Automatically adjust for Daylight Savings Time' checkbox; and 'Activity Lights' with an 'ON' toggle and a text box. At the bottom are 'Ok', 'Cancel', and 'Apply' buttons.

## Поиск и устранение неисправностей

Позволяет диагностировать проблемы маршрутизатора и проверять состояние сети.

The screenshot shows the 'Troubleshooting' settings page. It has a title bar with a close button. Below the title is a subtitle 'Troubleshoot router settings'. There are three tabs: 'Status', 'Diagnostics', and 'Logs'. The 'Diagnostics' tab is selected. The page is divided into several sections: 'Ping IPv4' with fields for IP or host name and number of pings, and a 'Start to Ping' button; 'Trace route' with a field for IP or host name and a 'Start to Traceroute' button; 'Reboot' with a 'Reboot the router' link; 'Router configuration' with 'Backup' and 'Restore' buttons; 'Router Firmware' with a 'Restore previous firmware' button; 'Internet Address' with IPv4 and IPv6 addresses and 'Release and Renew' links; and 'Factory reset' with a 'Reset to factory default settings' link. At the bottom is an 'Ok' button.

## Беспроводная сеть

Просмотр и изменение настроек беспроводной сети вашего маршрутизатора. Можно изменять имена сетей, режим безопасности, пароль, настраивать фильтрацию MAC-адресов и подключать устройства с помощью Wi-Fi Protected Setup.

Wireless  Show widget on the homepage

View and change router settings

Wireless MAC Filtering Wi-Fi Protected Setup

Smart Connect:  5 GHz band steering  Off  
5 GHz<sub>1</sub> + 5 GHz<sub>2</sub> Individual networks What is Smart Connect band steering?

Network name: arachnid 2.4 GHz Network:  ON

Password: peterparker Broadcast SSID: Yes Channel: Auto

Security mode: WPA2/WPA Mixed P Security mode: Mixed Channel width: Auto

Network name: arachnid\_5GHz 5 GHz<sub>1</sub> + 5 GHz<sub>2</sub> Network:  ON

Password: peterparker Broadcast SSID: Yes Channel: Auto

Security mode: WPA2/WPA Mixed P Security mode: Auto Channel width: Auto

Ok Cancel Apply

## Безопасность

Просмотр и изменение настроек безопасности беспроводной сети вашего маршрутизатора. Можно настроить брандмауэр, параметры VPN, а также выбрать пользовательские настройки для приложений и игр.

Security

View and change router settings

Firewall DMZ Apps and Gaming

**Firewall**

IPv4 SPI firewall protection  Enabled

IPv6 SPI firewall protection  Enabled

**Internet filters**

Filter anonymous Internet requests

Filter multicast

Filter Internet NAT redirection

Filter ident (Port 113)

**VPN Passthrough**

IPSec Passthrough  Enabled

PPTP Passthrough  Enabled

L2TP Passthrough  Enabled

**IPv6 Port Services**

Description	Protocol	IPv6 Address	Allow	Enabled
-------------	----------	--------------	-------	---------

Add IPv6 Firewall Setting

Ok Cancel Apply

# Поиск и устранение неисправностей

Для получения помощи обратитесь в нашу службу поддержки клиентов по адресу [linksys.com/support/EA8300](http://linksys.com/support/EA8300).

## Маршрутизатор не был успешно установлен

Если не удастся настроить маршрутизатор с помощью Linksys Smart Wi-Fi, попробуйте выполнить следующие действия:

- Нажмите и удерживайте кнопку сброса на маршрутизаторе с помощью скрепки или булавки до тех пор, пока эмблема Linksys не погаснет, а индикаторы MU-MIMO не начнут мигать (примерно 10 секунд). Установите маршрутизатор заново.

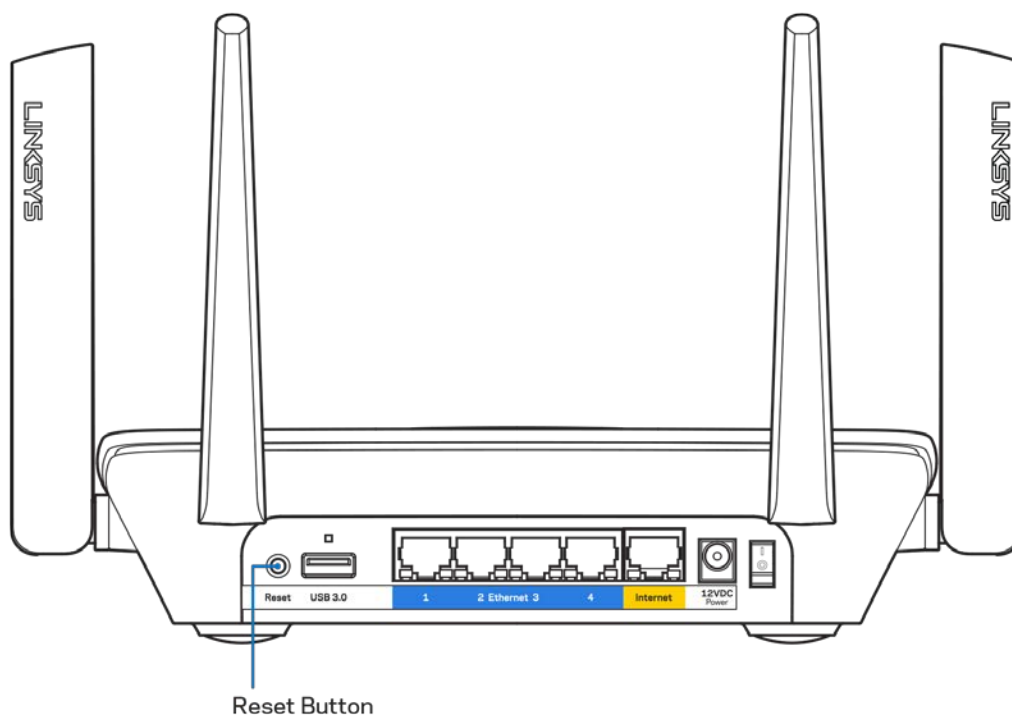

- Временно отключите брандмауэр компьютера (см. инструкции по безопасности программного обеспечения). Установите маршрутизатор заново.
- Если у вас есть другой компьютер, используйте этот компьютер для повторной попытки установки маршрутизатора.

## Сообщение «Кабель Интернета не подключен»

Если при настройке маршрутизатора отображается сообщение «Кабель Интернета не подключен», выполните следующие действия.

- Убедитесь, что кабель Ethernet или кабель подключения к Интернету (или кабель, аналогичный входящему в комплект поставки маршрутизатора) надежно подключен к желтому порту Интернета на задней панели маршрутизатора и к соответствующему порту модема. Этот порт на модеме обычно называется «Ethernet».

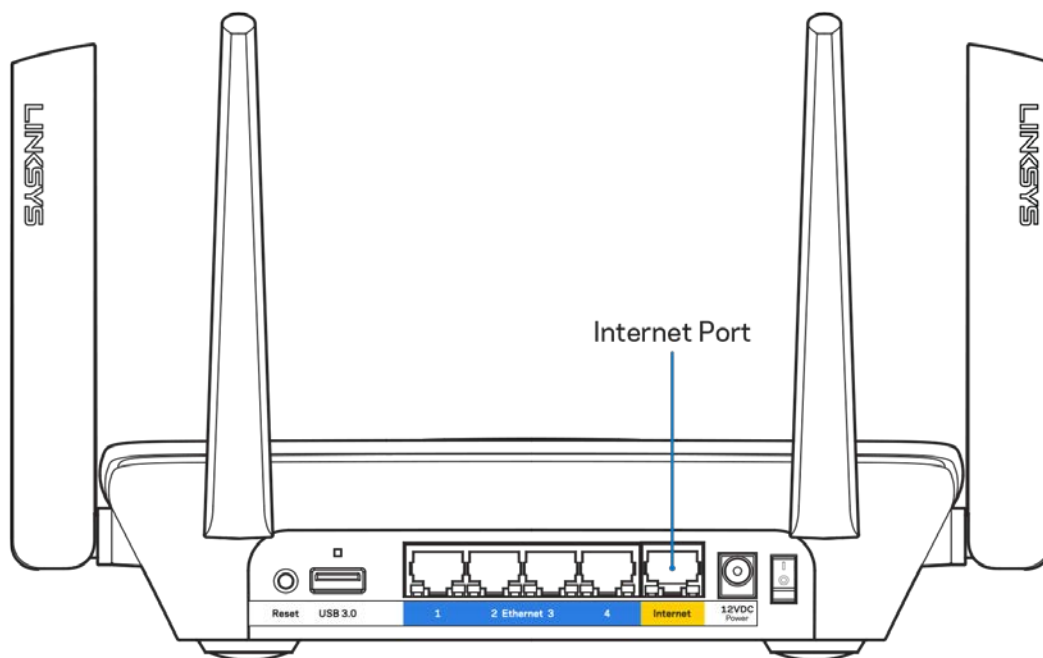

- Убедитесь, что модем подключен к электросети и включен. Если он оснащен выключателем питания, убедитесь, что выключатель находится в положении ON (ВКЛ.) или «I» (а не в положении «O»).

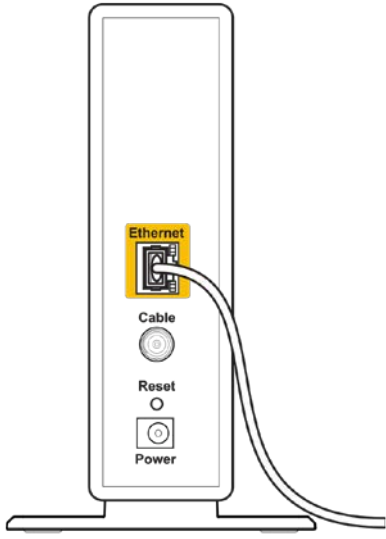
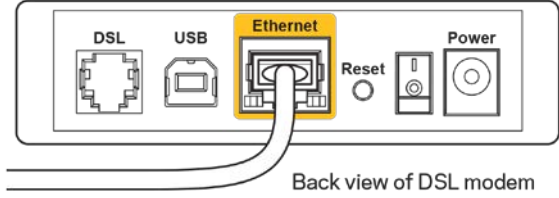

 <p>Back view of cable modem</p>	 <p>Back view of DSL modem</p>
<p>Если вы используете кабельное подключение к Интернету, убедитесь, что к порту «CABLE» модема подключен коаксиальный кабель, проведенный поставщиком услуг Интернета.</p>	<p>Если вы используете подключение DSL, убедитесь, что телефонный кабель DSL подключен к порту DSL модема.</p>

- Если компьютер был ранее подключен к модему с помощью кабеля USB, отсоедините кабель USB.
- Установите маршрутизатор заново.

### ***Сообщение «Маршрутизатор недоступен»***

Чтобы получить доступ к маршрутизатору, необходимо обеспечить подключение к вашей собственной сети. Если вы используете беспроводной доступ к Интернету, возможно, вы случайно установили подключение к другой беспроводной сети.

Чтобы устранить эту неполадку на компьютерах с Windows, выполните следующие действия\*:

1. Щелкните значок беспроводной сети в области уведомлений. Появится список доступных сетей.

- Щелкните название вашей сети. Щелкните «Подключить». В показанном ниже примере компьютер был подключен к другой беспроводной сети с именем wraith\_5GHz. В этом примере показано, что выбрано имя беспроводной сети маршрутизатора Linksys EA8300, Damaged\_Beez2.4.



- Если предлагается ввести ключ безопасности, введите пароль (ключ безопасности) в поле для ключа сети. Нажмите кнопку **OK**.
- Ваш компьютер установит подключение к сети, и вы получите доступ к маршрутизатору.

*\*Значки и названия кнопок в описании этих действий могут отличаться в зависимости от версии Windows.*

Чтобы устранить неполадку на компьютерах Mac:

- В строке меню в верхней части экрана нажмите значок Wi-Fi. Появится список беспроводных сетей.
- В показанном ниже примере компьютер был подключен к другой беспроводной сети с именем wraith\_5GHz. В этом примере показано, что выбрано имя беспроводной сети маршрутизатора Linksys EA8300, Damaged\_Beez2.4.



3. Щелкните имя беспроводной сети маршрутизатора Linksys EA8300 (в этом примере — Damaged\_Beez2.4).
4. Введите пароль беспроводной сети (ключ безопасности) в поле «Пароль». Нажмите **ОК**.

## После настройки

### Интернет по-прежнему недоступен

Если маршрутизатору не удастся установить подключение к Интернету, в веб-браузере может появиться сообщение «Не удалось найти [адрес в Интернете]». Если вы уверены, что введен правильный адрес, и пробовали вводить несколько заведомо действующих адресов с таким же результатом, возможно, возникла неполадка из-за неисправностей оборудования у поставщика услуг Интернета или неполадка при передаче данных между модемом и маршрутизатором. Попытайтесь выполнить следующие действия:

- Убедитесь, что сетевой кабель и кабель питания надежно подключены.
- Убедитесь, что розетка питания, к которой подключен маршрутизатор, исправна.
- Перезагрузите маршрутизатор
- Свяжитесь с поставщиком услуг Интернета и узнайте о перебоих в работе в вашем районе.

Самый распространенный способ устранения неисправностей маршрутизатора — выключить его, а затем снова включить. Тогда маршрутизатор сможет перезагрузить пользовательские настройки, а другие устройства (такие как модем) смогут заново обнаружить маршрутизатор и установить с ним связь. Этот процесс называется перезагрузкой.

Чтобы перезагрузить маршрутизатор с помощью кабеля питания, выполните следующие действия:

1. Отсоедините кабель питания от маршрутизатора и модема.
2. Подождите 10 секунд и снова подключите кабель питания к модему. Убедитесь, что питание поступает.
3. Подождите, пока индикатор не перестанет мигать индикатор «Сеть» модема (около двух минут). Снова подключите кабель питания к маршрутизатору.

4. Дождитесь, пока загорится подсветка эмблемы Linksys. Подождите две минуты перед подключением к Интернету с компьютера.

Чтобы перезагрузить маршрутизатор с помощью Linksys Smart Wi-Fi, выполните следующие действия:

1. Войдите в Linksys Smart Wi-Fi. (См. «Подключение к Linksys Smart Wi-Fi» на стр. [11](#).)
2. В разделе *Настройки маршрутизатора* нажмите *Поиск и устранение неисправностей*.
3. Перейдите на вкладку *«Диагностика»*.
4. В разделе *Перезагрузка* щелкните *Перезагрузка*.



5. Щелкните **«Да»**. Маршрутизатор перезагрузится. В процессе перезагрузки подключение всех устройств к Интернету будет прервано, а после перезагрузки оно автоматически восстановится.

## Linksys Smart Wi-Fi не открывается в браузере.

Последние версии Google Chrome™, Firefox®, Safari® (для Mac® и iPad®), Microsoft Edge и Internet Explorer® версии 8 и более поздних версий совместимы с Linksys Smart Wi-Fi.

# Технические характеристики

## Linksys EA8300

Название модели	Трёхдиапазонный маршрутизатор Max-Stream AC2200 MU-MIMO
Номер модели	EA8300
Скорость порта:	10/100/1000 Мбит/с (гигабитный Ethernet)
Радиочастота	2,4 ГГц и 5 ГГц (два диапазона)
Кол-во антенн	4 несъемных поворотных антенн
Порты	USB 3.0, Ethernet (1-4), Интернет, питание
Кнопки	Wi-Fi Protected Setup, питание, сброс
Индикаторы	<b>Верхняя панель:</b> Подсвеченная эмблема Linksys, Wi-Fi Protected Setup, подключение к Интернету, подключение кабеля к порту Интернета <b>Задняя панель:</b> USB, Ethernet (1-4), Интернет
UPnP	Поддерживается
Безопасность	WEP, WPA2, RADIUS
Разрядность ключа безопасности	128-битное шифрование
Поддерживаемые файловые системы	FAT, NTFS и HFS+
Поддерживаемые браузеры	Последние версии Google Chrome™, Firefox®, Safari® (для Mac® и iPad®), Microsoft Edge и Internet Explorer® 8 или более поздних версий

## Физические характеристики

Размеры	213,7 x 161,8 x 54,8 мм (без антенн)
Масса	608 г
Питание	12 В, 2 А
Сертификация	FCC, IC, CE, Wi-Fi (a/b/g/n/ac)
Рабочая температура	От 0 до 40 °C
Температура при хранении	От -20 до 60 °C
Влажность воздуха при работе	От 10 до 80 % относительной влажности без конденсации
Влажность воздуха при хранении	От 5 до 90 % без конденсации

Технические характеристики могут быть изменены без уведомления.

Примечания.

Сведения о соответствии требованиям, гарантии и безопасности см. на компакт-диске, который поставляется вместе с маршрутизатором, или по адресу [Linksys.com/support/EA8300](http://Linksys.com/support/EA8300).

Максимальная производительность рассчитана в соответствии со спецификациями стандарта IEEE 802.11. Фактические характеристики, включая емкость, пропускную способность, диапазон и покрытие беспроводной сети, могут отличаться от указанных. Производительность зависит от многих факторов, условий и переменных величин, в том числе расстояния от точки доступа, объема сетевого трафика, материалов и конструкции здания, используемой операционной системы, сочетания беспроводных устройств, помех и других неблагоприятных условий.

BELKIN, LINKSYS и многие названия продуктов и эмблемы являются товарными знаками группы компаний Belkin. Упомянутые здесь товарные знаки сторонних компаний являются собственностью соответствующих владельцев. Лицензии и документацию по программному обеспечению сторонних производителей см. здесь: <http://support.linksys.com/en-us/license>. Чтобы задать вопрос или запросить исходный код GPL посетите <http://support.linksys.com/en-us/gplcodecenter>.

© Belkin International, Inc. и аффилированные организации, 2017 г. Все права защищены.

**LINKSYS®**

用户指南

MAX-STREAM™  
AC2200 MU-MIMO  
三频段路由器

型号：EA8300

# 目录

产品概览 .....	3
顶视图.....	3
系统状态指示灯 .....	4
后视图.....	5
侧视图.....	6
设置： 基本信息 .....	7
如何查找更多帮助.....	7
如何安装您的路由器.....	8
如何使用Linksys Smart Wi-Fi .....	11
如何连接到Linksys Smart Wi-Fi.....	11
网络地图.....	12
来宾访问.....	12
家长控制功能.....	13
媒体优先次序.....	13
速度测试.....	14
外部储存.....	14
连接.....	15
故障排除.....	15
无线.....	16
安全.....	16
故障排除 .....	17
您的路由器设置失败.....	17
{99} 消息：您网线未插入 {100} {101} {102} .....	18
{105} 消息 {106} {107} {108}：无法访问您的路由器.....	19
安装完成后.....	21
Internet似乎不可用.....	21
无法在您的网页浏览器中打开Linksys Smart Wi-Fi.....	21
规格 .....	22
Linksys EA8300.....	22
环境要求.....	22



# 产品概览

## 顶视图

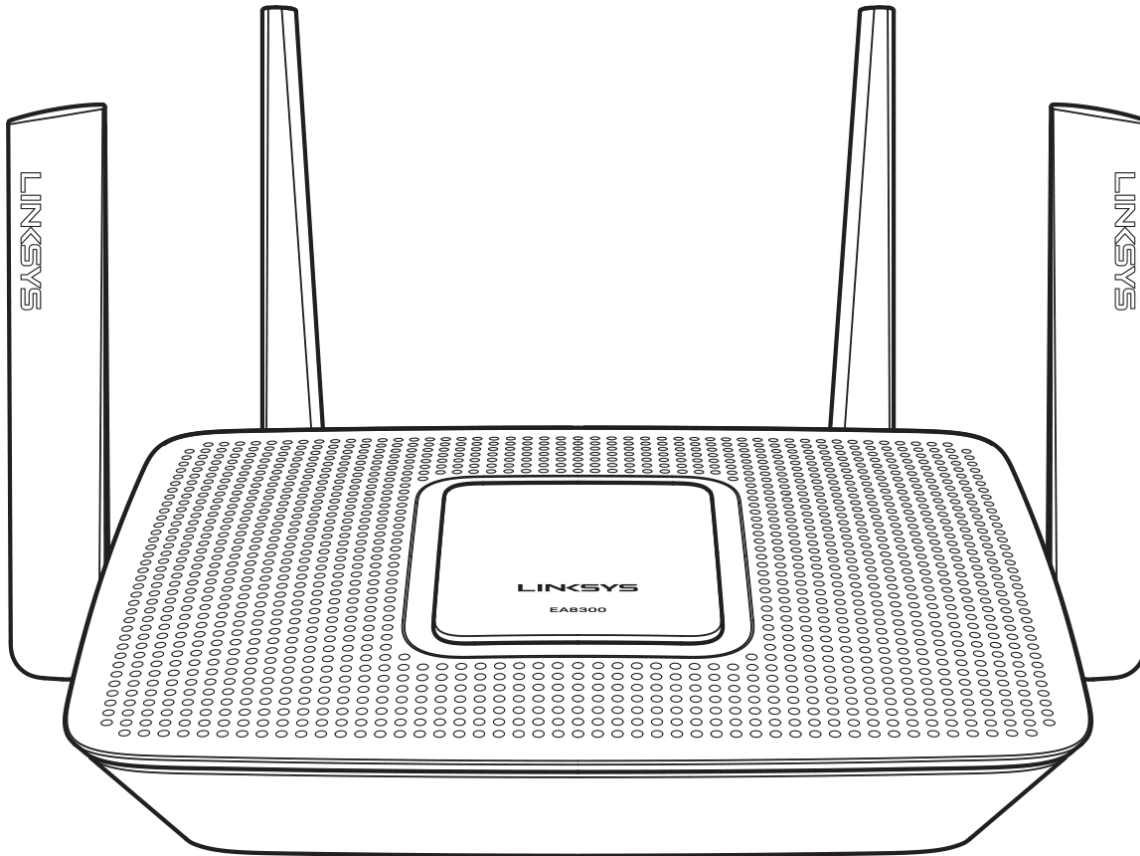

## 系统状态指示灯

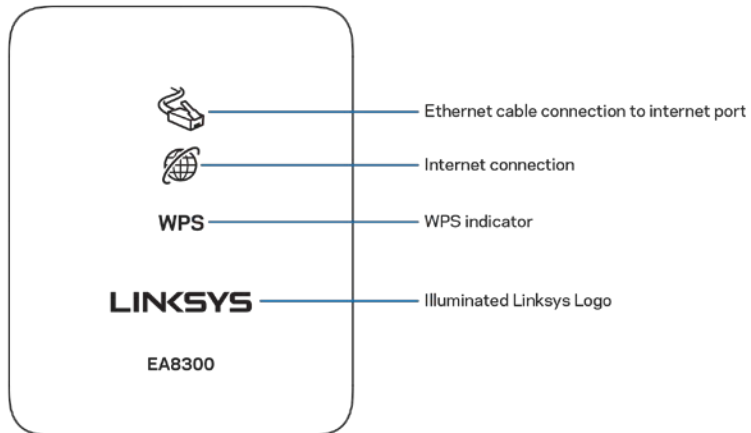

Internet端口的以太网线连接：如果指示灯亮起（橙色），则表示连接到Internet（WAN）端口的网线出现问题。

Internet连接：如果指示灯亮起（橙色），则表示路由器无法访问Internet。

{9} WPS（Wi-Fi保护设置{10} {11}™{12} {13}）指示灯 {14}：WPS指示灯有四种状态：

关闭	Wi-Fi保护设置不活动
闪烁白色	Wi-Fi保护设置在进行中
常亮白色	Wi-Fi保护设置已成功；保持亮起5秒钟
闪烁橙色	Wi-Fi保护设置出现错误；闪烁一分钟，然后熄灭

发光Linksys徽标：在路由器启动时，徽标开始闪烁。当徽标转为常亮白色，即表明路由器已开启并正常运行。

## 后视图

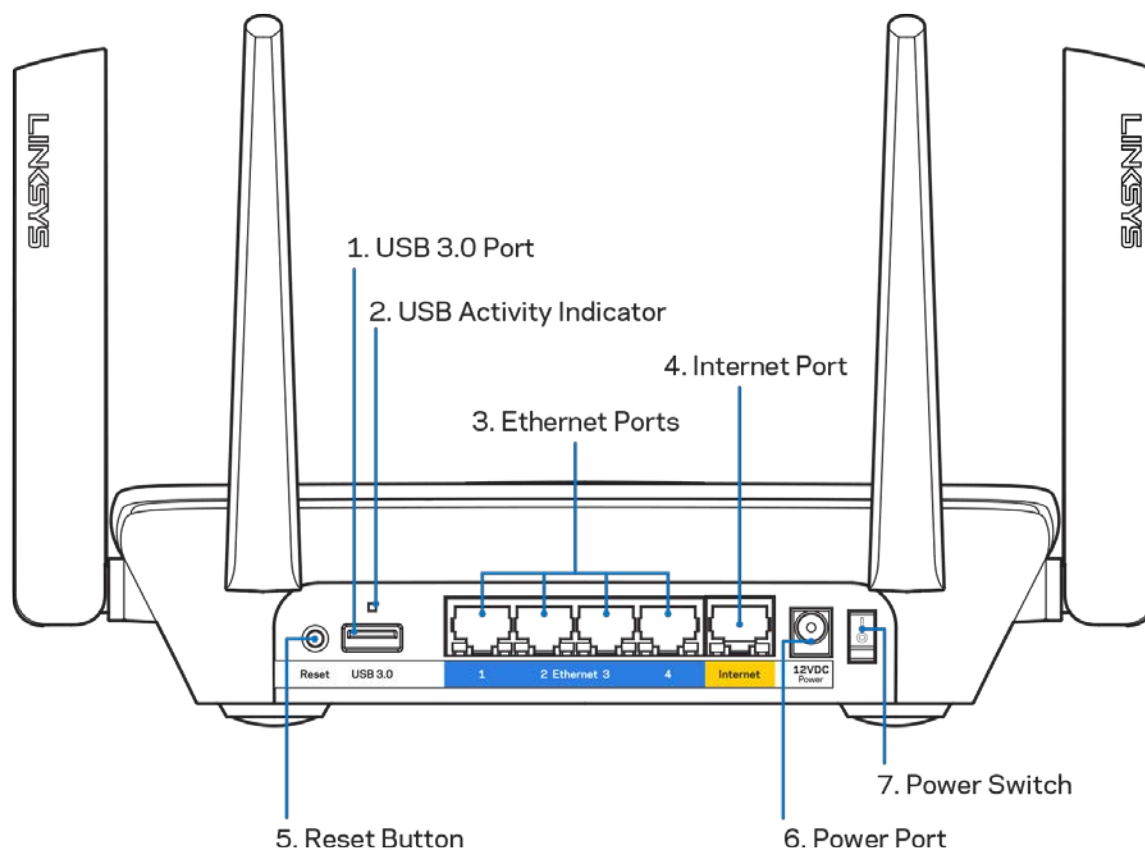

USB 3.0端口（1）：在您的网络或Internet上连接并分享U盘中的内容。

USB活动指示灯（2）：指示灯表示数据与外部设备的传输情况。

{29} 以太网端口（3）{30} {31}：{32} 将以太网线插入到这些蓝色千兆（10/100/1000）端口，并且连接至您网络上的有线设备。

**注意：**{37} 为了获得最佳性能，请在以太网端口上使用CAT5e或更高额定的网线。{38}

Internet端口（4）：将以太网线插入到该黄色千兆（10/100/1000）端口，并且连接至宽带Internet网线/DSL或光纤调制解调器。

**注意：**{47} 为了获得最佳性能，请在Internet端口上使用CAT5e或更高额定的网线。{48}

重置按钮（5）：按住此按钮，直到发光Linksys徽标指示灯熄灭，再将路由器重置为出厂设置。此外，您也可通过Internet或移动应用上的Linksys Smart Wi-Fi进行恢复出厂设置操作。

电源端口（6）{55}：用于连接随附的交流电电源适配器。{56}

{57} 电源开关（7）{58}：按下电源开关|（开启），打开路由器。

## 侧视图

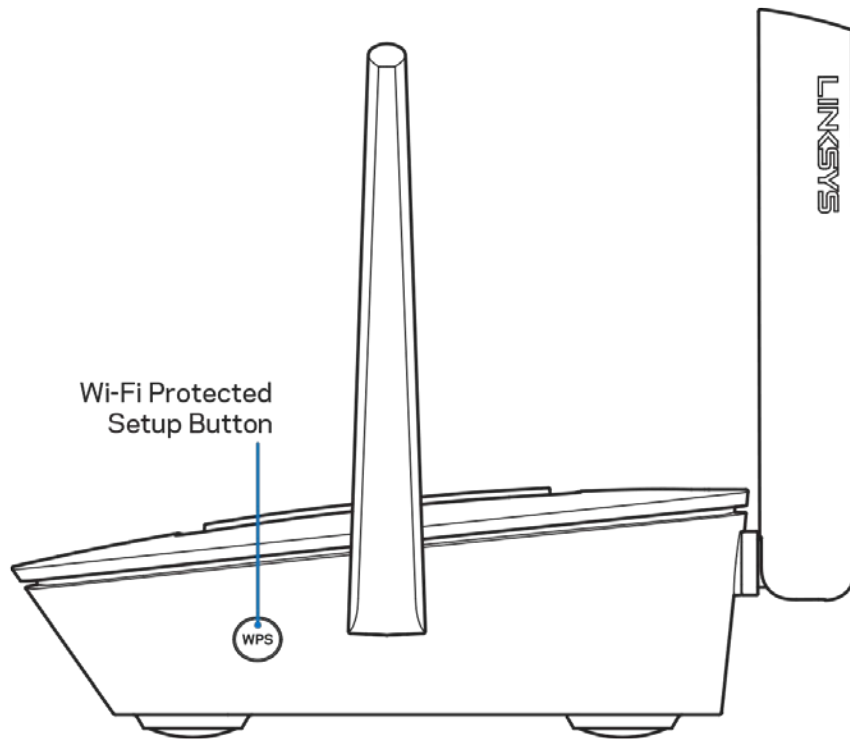

Wi-Fi保护设置™按钮 {67}：按下按键并连接到已启用WPS的网络设备。{68}

# 设置： 基本信息

## 如何查找更多帮助

除本用户指南之外，您还可通过以下网址获得帮助：

- [Linksys.com/support/EA8300](http://Linksys.com/support/EA8300)（文件、下载、FAQs、技术支持、在线客服、论坛）
- Linksys Smart Wi-Fi（连接到Linksys Smart Wi-Fi，然后点击屏幕顶部的“帮助”）

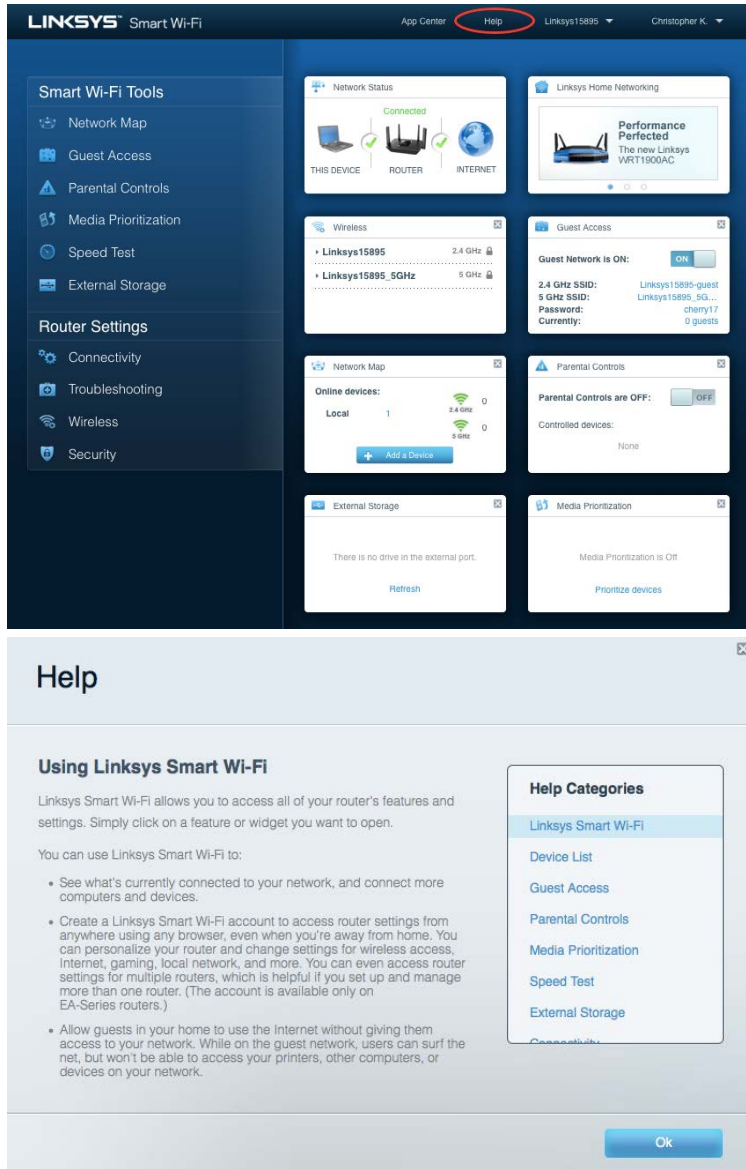

{69} 注意：{70} 本产品所使用的第三方软件之许可和通知可从以下链接查看：<http://support.linksys.com/en-us/license>。请联系<http://support.linksys.com/en-us/gplcodecenter>，以获取问题或GPL源代码请求。

## 如何安装您的路由器

1. 如需完成设置，您需要通过计算机打开网页浏览器访问<http://LinksysSmartWiFi.com>。
2. 识别您的设备。

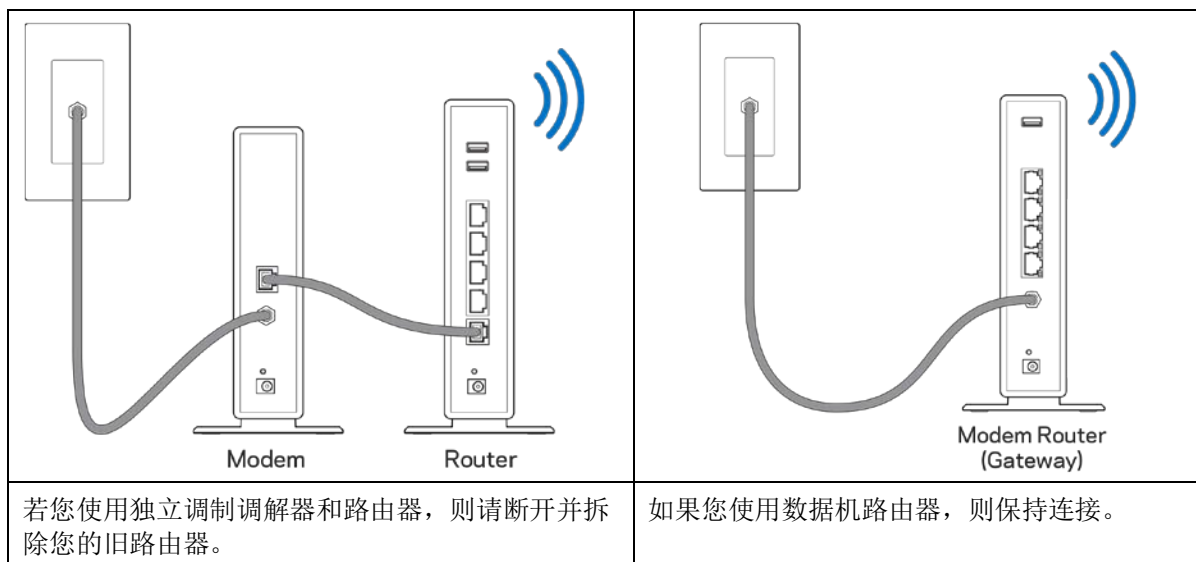

3. 竖直放置天线，并插上路由器的电源。请确保电源开关处于 |（开启）位置。
4. 连接您的路由器至您的调制解调器或数据机路由器。将包含的Internet网线一端插入您新路由器的黄色Internet端口。如果您使用调制解调器，则将另一端插入到调制解调器上的以太网（LAN）端口。如果您使用数据机路由器，则可插入任何可用的端口。
5. 等待直到您路由器顶部的发光Linksys指示灯停止闪烁，并且转为常亮白色。
6. 连接到您的路由器随附的《快速入门指南》中所示的Wi-Fi名称。（您可以稍后更改这些细节。）如果您需要获得连接网络方面的帮助，请访问[linksys.com/support/EA8300](http://linksys.com/support/EA8300)，参考您的设备文件。

**注意：**在路由器设置完成之前，您将无法访问Internet。

7. 打开网页浏览器访问<http://LinksysSmartWiFi.com>。遵循屏幕上的指示，完成您的路由器设置。您还可以在浏览器中输入192.168.1.1，以开始设置。

在设置操作最后，按照屏幕上的说明设置您的Linksys Smart Wi-Fi帐户。使用Linksys Smart Wi-Fi，从任意拥有Internet连接的计算机配置您的路由器。

管理您的路由器设置：

- 更改路由器的名称和密码
- 设置来宾访问权限
- 配置家长控制功能
- 将设备连接至您的Wi-Fi
- 测试您的Internet连接速度

{77}注意：{78} {79}作为{80}Linksys Smart Wi-Fi帐户设置的一部分{81}，您将收到一个验证电子邮件。{82}在您的家庭网络中，[点击电子邮件中的链接](#)，将您的路由器连接到Linksys Smart Wi-Fi帐户。

{83}提示{84}：打印下一页面，然后在表格记录您的路由器和帐户设置，以作为参考。将您的记录储存至安全的地方。

2.4 GHz Wi-Fi名称	
Wi-Fi密码	
5 GHz <sub>1</sub> Wi-Fi名称	
Wi-Fi密码	
5 GHz <sub>2</sub> Wi-Fi名称	
Wi-Fi密码	
路由器密码	
2.4 GHz来宾Wi-Fi名称	
5GHz来宾Wi-Fi名称	
来宾Wi-Fi密码（共享密码）	
Linksys Smart Wi-Fi用户名	
Linksys Smart Wi-Fi密码	



# 如何使用Linksys Smart Wi-Fi

通过使用Linksys Smart Wi-Fi，您可随时随地管理您的路由器，此外，您也可以直接通过您的家庭网络管理您的路由器。您的移动设备可能也可使用Linksys Smart Wi-Fi应用。请查看您设备的应用商店，以了解更多信息。

## 如何连接到Linksys Smart Wi-Fi

如需连接到Linksys Smart Wi-Fi：

1. 打开您计算机的网页浏览器。
2. {91} 进入 {92} <http://LinksysSmartWiFi.com> {95}，并登录您的账户。{96}



如果您忘记了密码，请点击 {97} “忘记密码？” {98}，然后按照屏幕指示找回密码。

## 网络地图

允许您显示并管理所有连接到路由器的网络设备。 您可查看您的网络和您的来宾网络上的各种设备，或显示每个设备的信息。



## 来宾访问

允许您设置来宾网络并对其进行监控，以供来宾访问Wi-Fi，而不会暴露个人信息。

The screenshot shows a 'Guest Access' configuration window. It features a 'Show widget on the homepage' checkbox. Under 'Allow guest access', there is an 'ON' toggle switch. A warning box contains the text: 'Your guest should first connect to your guest network, open a web browser, and then enter the guest password.' Below this, 'Guest network names and password' are listed: '2.4 GHz SSID: parlor2.4' and '5 GHz SSID: parlor5', both with 'Network: Enabled'. The 'Guest network password' is 'theyfy'. At the bottom, 'Total guests allowed' is set to '5 guests' via a dropdown menu. 'OK' and 'Cancel' buttons are at the bottom right.

## 家长控制功能

允许您阻止各种网站并设置Internet访问时间。

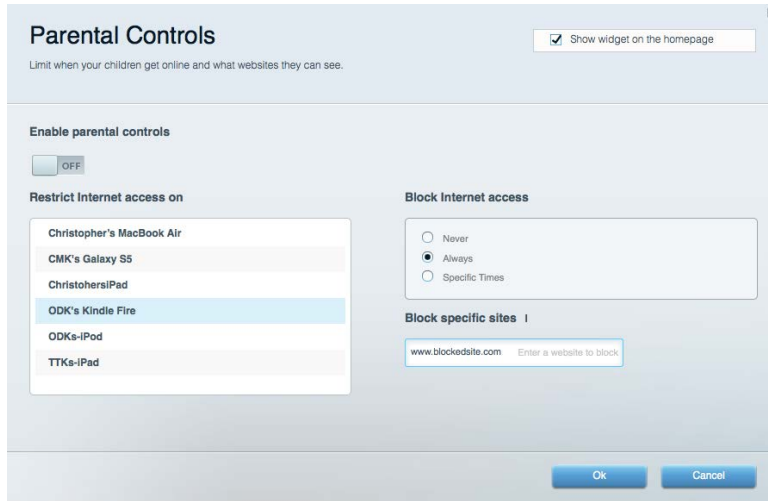

## 媒体优先次序

允许您设置哪些设备和应用可在您的网络通讯中享有最高优先级。

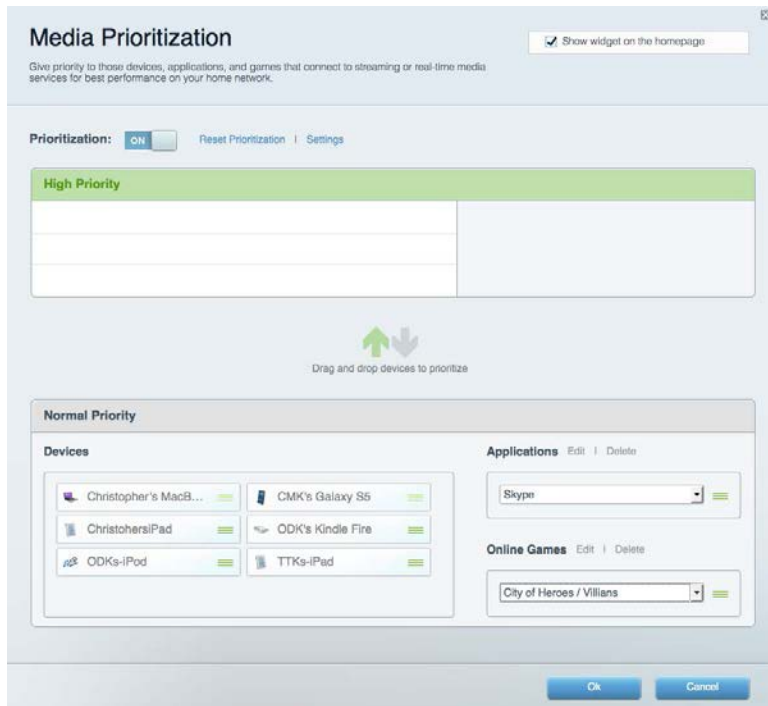

## 速度测试

允许您测试您网络的Internet连接速度。



## 外部储存

允许您访问附加的U盘（不含）并设置文件共享、媒体服务器和FTP访问。



## 连接

允许您查看并更改基本和高级网络设置。

The screenshot shows the 'Connectivity' settings page with the following sections:

- Network Name and Password | Edit**
  - 2.4 GHz network name: arachnid
  - Network password: peterparker
  - 5 GHz<sub>1</sub> + 5 GHz<sub>2</sub> network name: arachnid\_5GHz
  - Network password: peterparker
- Router Password | Edit**
  - Router password: \*\*\*\*\*
- Router Firmware Update**
  - Automatic (Current Version: 1.1.5.164615)
  - Check for Updates
- Time Zone**
  - (GMT-05:00) Eastern Time (USA & Canada)
  - Automatically adjust for Daylight Savings Time
- Activity Lights**
  - ON
  - Enable/disable activity lights. Power light will remain on.

Buttons at the bottom: Ok, Cancel, Apply.

## 故障排除

允许您对您的路由器进行问题诊断并检查网络状态。

The screenshot shows the 'Troubleshooting' settings page with the following sections:

- Ping IPv4**
  - IP or host name: [input field]
  - Number to ping: 5
  - Start to Ping
- Trace route**
  - IP or host name: [input field]
  - Start to Traceroute
- Reboot**
  - Reboot the router
- Router configuration**
  - Backup
  - Restore
- Router Firmware**
  - Restore previous firmware
- Internet Address:**
  - IPv4: 10.0.0.253 (Release and Renew)
  - IPv6: 2801:0540::000:0019:0000:0000:0000:314e (Release and Renew)
- Factory reset**
  - Reset to factory default settings

Button at the bottom: Ok.

## 无线

允许您查看并更改路由器的无线网络。您可以更改网络名称、安全模式、密码、MAC过滤，并通过Wi-Fi安全设置功能连接各种设备。

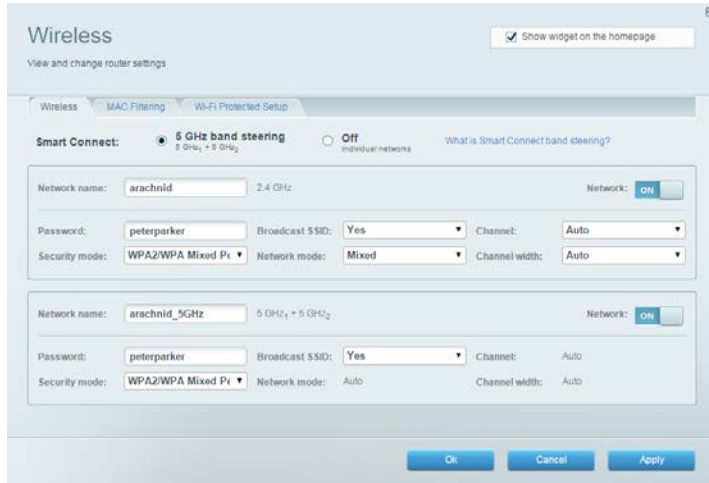

## 安全

允许您查看并更改路由器的无线安全性。您可以进行防火墙设置、VPN设置，并且对各种应用程序和游戏进行自定义设置。

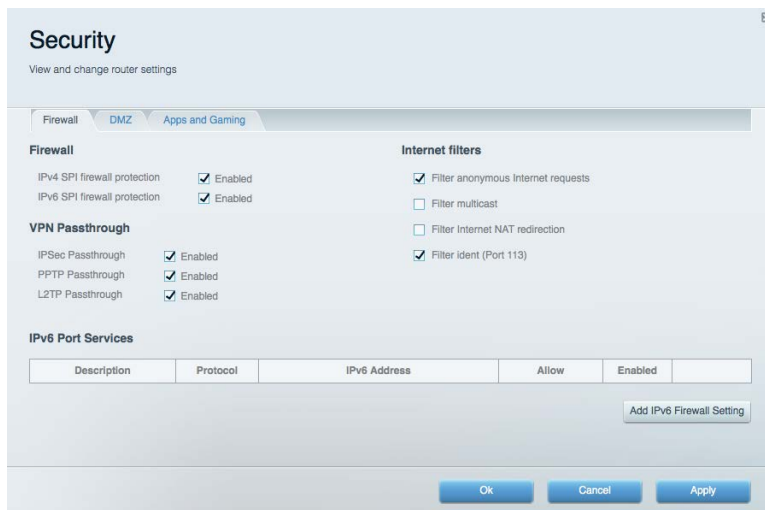

# 故障排除

您可以访问[linksys.com/support/EA8300](http://linksys.com/support/EA8300)，以通过我们备受赞誉的客户支持服务获得更多帮助。

## 您的路由器设置失败

如果Linksys Smart Wi-Fi无法完成设置，您可尝试以下操作：

- 使用回纹针或大头针按住您路由器上的重置按钮，直到发光Linksys徽标熄灭，且蓝色的MU-MIMO指示灯开始闪烁（大约10秒钟）。重新安装路由器。

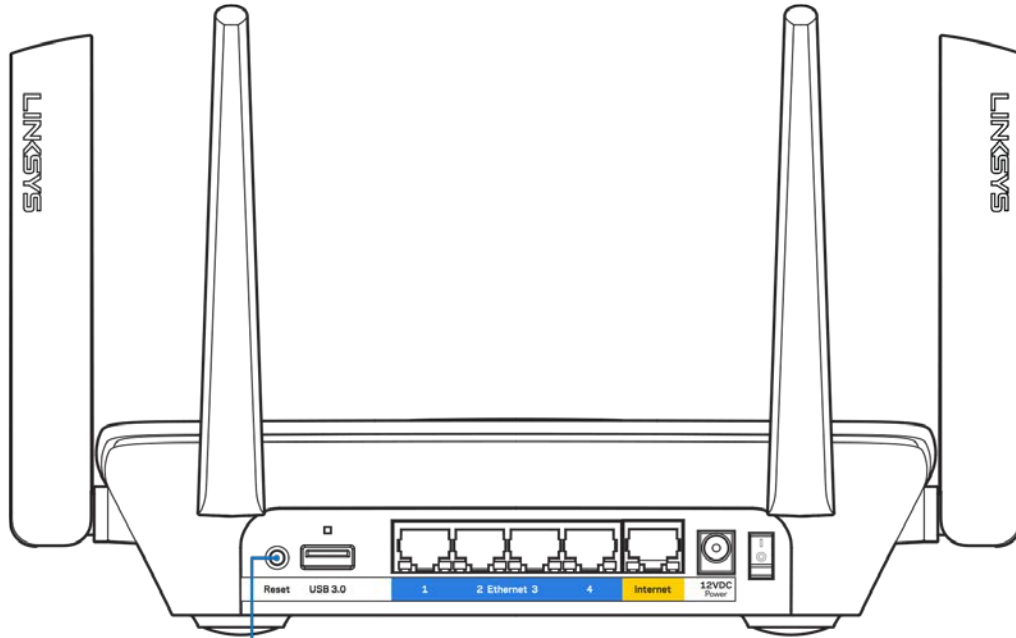

Reset Button

- 临时禁用您计算机的防火墙（请参考安全软件指南，以获得更多帮助）。重新安装路由器。
- 如果您拥有第二台计算机，则使用该计算机再次安装路由器。

## {99} 消息：您网线未插入 {100} {101} {102}

如果您在尝试设置您的路由器时收到“您的网线未插入”的消息，请按照以下故障排除步骤进行操作。

- 请确保以太网或Internet网线（或一条类似路由器所随附的线缆）牢固地连接到路由器背后的黄色Internet端口以及调制解调器的适当端口上。调制解调器的端口通常标记为以太网端口。

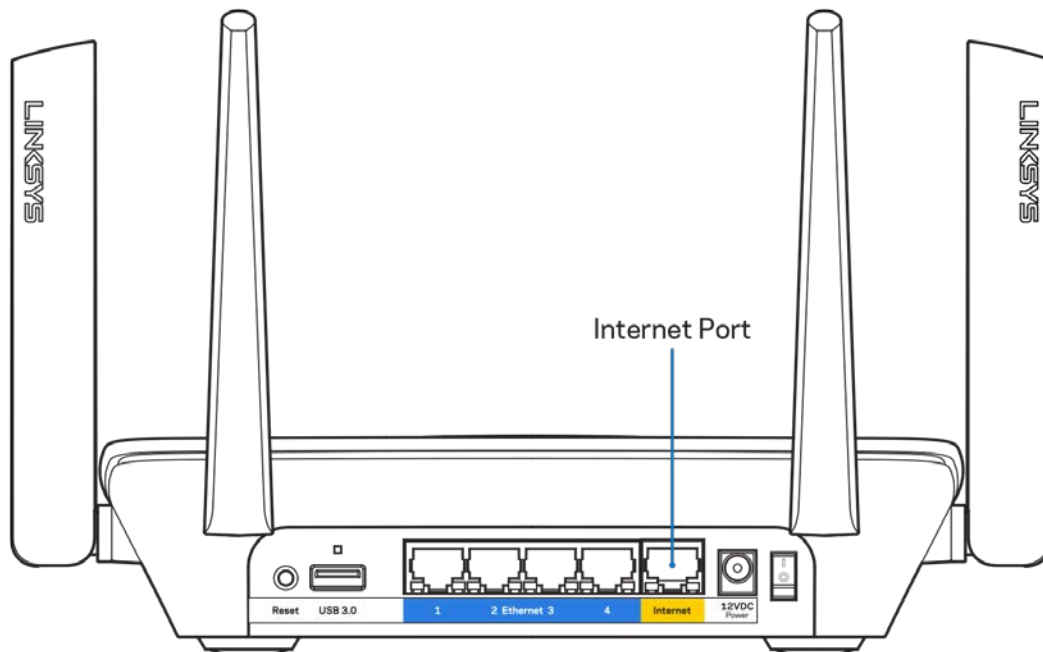

- 请确保您的调制解调器接上电源并处于开启状态。如果有电源开关，请确保该开关在“开启”或“|（相反位置为0）”位置。

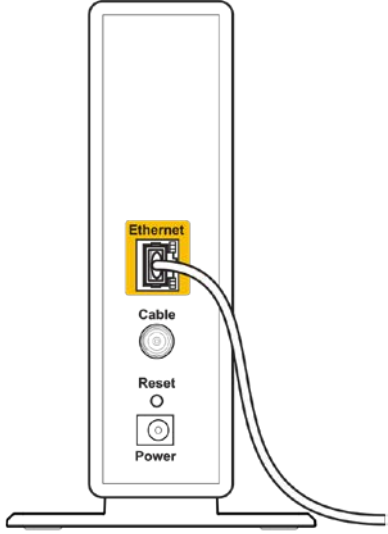
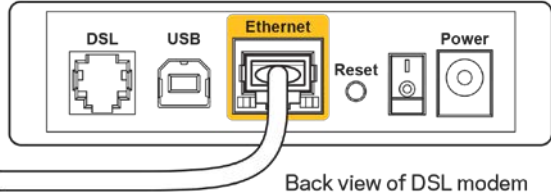

 <p style="text-align: center;">Back view of cable modem</p>	 <p style="text-align: center;">Back view of DSL modem</p>
<p>如果您的Internet服务是电缆接入，请确认您的Internet服务提供商（ISP）所提供的同轴电缆连接到电缆调制解调器的电缆端口上。</p>	<p>如果您的Internet服务是DSL接入，请确保DSL电话线连接到调制解调器的DSL端口上。</p>

- 如果您的计算机之前曾使用USB线缆连接到您的调制解调器，请断开该USB线缆。
- 重新安装路由器。

## 消息：无法访问您的路由器

如需访问您的路由器，您必须连接到您自己的网络。如果您使用无线Internet连接，问题的原因可能是您意外连接到其他无线网络。

在Windows计算机上解决问题，请遵循以下步骤\*：

1. 点击系统托盘中的无线图标。出现一个可用网络列表。

2. 点击您自己的网络名称。 点击“连接”。 在下文所示的示例中，该计算机已连接到另一个名为“wraith\_5GHz”的无线网络。 在此示例中，我们选择了名为“Damaged\_Beez2.4”的Linksys EA8300无线网络。



3. {109} 如果您收到输入网络安全密钥的提示，请将您的密码（安全密钥）输入到网络 {110} {111} 安全密钥 {112} {113} 对话框中。 {114} {115} 点击 {116} {117} “OK（确定）” {118} {119}。 {120}
4. 您的计算机将连接到网络，现在您可以访问路由器。

\*根据您的计算机版本，在这些步骤中的用词或图标可能会存在差异。

如需在Mac计算机上解决问题，请遵循以下步骤：

1. 在屏幕上方的菜单栏中点击Wi-Fi图标。 出现一个无线网络列表。
2. 在下文所示的示例中，该计算机已连接到另一个名为“wraith\_5GHz”的无线网络。 在此示例中，我们选择了名为“Damaged\_Beez2.4”的Linksys EA8300无线网络。

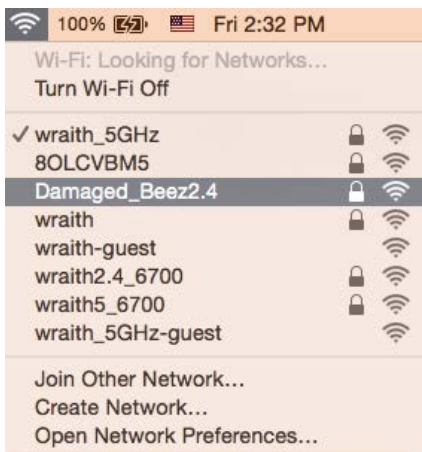

3. 单击您的Linksys EA8300的无线网络名称（在此示例中为“Damaged\_Beez2.4”）。
4. {121}在{122} {123} “密码” {124} {125}栏中输入您的无线网络密码（安全密钥）。{126} {127}单击{128} {129} “OK（确定）” {130} {131}。{132}

## 安装完成后

### Internet似乎不可用

如果您的路由器无法连接到Internet，则您的网页浏览器将会出现提示信息“无法找到[Internet地址]”。如果您确定该Internet地址正确，并且，如果您已经多次尝试了有效的Internet地址但结果相同的话，则该信息将意味着您的路由器无法连接到您的ISP或调制解调器。请尝试以下步骤：

- 确保网络和电源线均安全连接。
- 确保您路由器的电源插座正确连接。
- 重启您的路由器。
- 联系您所在区域的ISP，并咨询有关服务中断情况。

检修您路由器的最常用方法是关闭电源，然后重启。然后您的路由器可以重载其自定义设置，而其他设备（例如调制解调器）将可以重新发现路由器并且与其连接。此过程称为“重启”。

通过电源线重启您的路由器，请遵循以下步骤：

1. 断开路由器和调制解调器的电源线。
2. 等待10秒钟，然后重新连接调制解调器的电源线。确保通电正常。
3. 等待直到调制解调器的在线指示灯停止闪烁（大概2分钟）。重新连接路由器的电源线。
4. 等待直到发光Linksys徽标亮起。在尝试从一台电脑连接到Internet之前，请等待2分钟。

如需通过Linksys Smart Wi-Fi重启您的路由器，请遵循以下步骤：

1. 登录Linksys Smart Wi-Fi。（请参考页面上“如何连接到Linksys Smart Wi-Fi<sup>11</sup>”的说明。）
2. 在{134} “路由器设置” {135}菜单中单击{136} “故障排除”。{137}
3. 单击{138} “Diagnostics（诊断）” {139}选项卡。
4. 在{140} “重启” {141}菜单中单击{142} “重启” {143}。



5. {144}单击{145} {146} “是” {147} {148}。{149} 此时路由器将重启。在路由器重启的过程中，所有已连接的设备将失去其Internet连接，但在路由器重新就绪后将自动重新连接。

### 无法在您的网页浏览器中打开Linksys Smart Wi-Fi

兼容Linksys Smart Wi-Fi的最新版本™、Firefox {154}®、Safari®（适用于Mac®和iPad®）、Microsoft Edge、以及Internet Explorer® {163} 版本8和更高版本，{164} {165}

# 规格

## Linksys EA8300

型号名称	Max-Stream AC2200 MU-MIMO三频段路由器
产品型号	EA8300
交换机端口速度	10/100/1000Mbps (千兆以太网)
无线电频率	2.4 GHz和5 GHz (x2)
天线数量	4条外部可调天线 (不可拆卸)
端口	USB 3.0端口、以太网端口 (1-4)、Internet端口、电源端口
按钮	Wi-Fi安全设置按钮、电源按钮、重置按钮
指示灯	顶板: 发光Linksys徽标、Wi-Fi保护设置、Internet连接、Internet端口网线连接 后面板: USB 指示灯、以太网 (1-4) 指示灯、Internet指示灯
UPnP	支持
安全特性	WEP、WPA2、RADIUS
安全密钥值	高达128位加密
存储文件系统支持	FAT、NTFS和HFS+
浏览器支持	最新版本的Google Chrome™、Firefox®、Safari® (适用于Mac®和iPad®)、Microsoft Edge、Internet Explorer®版本8和更高版本。

## 环境要求

尺寸	213.7mm x 161.8mm x 54.8mm (不带天线)
单位重量	608 g
电源	12V, 2A
认证	FCC、IC、CE、Wi-Fi (a/b/g/n/ac)
工作温度	32至104° F (0至40° C)
存储温度	-4至140° F (-20至60° C)
工作湿度	10%至80%相对湿度, 无冷凝
存储湿度	5%至90%, 无冷凝

如规格发生变化, 恕不另行通知。

注意：

如需了解控制标准、保修、安全相关信息，请查看您路由器随附CD的内容或访问 [Linksys.com/support/EA8300](http://Linksys.com/support/EA8300)。

最佳性能源自IEEE标准801.11规范。实际性能可能有所变化，包括无线网络功能降低，数据吞吐率减小，距离和覆盖范围缩小。性能取决于很多因素、条件和变量，包括与接入点的距离、网络通信量、建筑物材料和构造、所使用的操作系统、无线产品组合、干扰和其他不利条件。

BELKIN、LINKSYS以及众多产品名称和徽标均为贝尔金公司集团的商标。所述的第三方商标均为其各自所有者之财产。本产品所使用的第三方软件之许可和通知可从以下链接查看：<http://support.linksys.com/en-us/license{176}>。{177} {178}请联系{179}<http://support.linksys.com/en-us/gplcodecenter>，以获取问题或GPL源代码请求。

© 2017贝尔金国际有限公司及/或其附属公司。 版权所有。

**LINKSYS®**

Návod na používanie

**Troj pásmový smerovač**  
**MAX-STREAM™**  
**AC2200 MU-MIMO**

Model EA8300

# Obsah

Opis výrobku.....	3
Pohľad zvrchu.....	3
Indikátor stavu systému .....	4
Podhľad zozadu .....	5
Pohľad z boku .....	6
Nastavenie: Základy .....	7
Získanie pomoci .....	7
Inštalácia smerovača .....	8
Používanie služby Linksys Smart Wi-Fi.....	11
Pripojenie k službe Linksys Smart Wi-Fi.....	11
Mapa siete.....	12
Guest Access (Prístup hostí).....	12
Rodičovská kontrola (Parental Controls).....	13
Prioritizácia médií (Media Prioritization).....	13
Test rýchlosti (Speed Test) .....	14
Externé úložisko.....	14
Možnosti pripojenia (Connectivity).....	15
Riešenie problémov.....	15
Bezdrôtová sieť (Wireless).....	16
Zabezpečenie (Security) .....	16
Riešenie problémov .....	17
Your router was not successfully set up (Inštalácia smerovača nebola úspešná) .....	17
Hlásenie <i>Your Internet cable is not plugged in</i> (Internetový kábel nie je pripojený) .....	18
Hlásenie <i>Cannot access your router</i> (Nie je možný prístup k smerovaču).....	19
Po inštalácii.....	21
Nie je dostupná sieť internet .....	21
Vo webovom prehliadači sa neotvorí služba Linksys Smart Wi-Fi.....	22
Technické údaje .....	23
Linksys EA8300 .....	23
Fyzické .....	23

# Opis výrobku

## Pohľad zvrchu

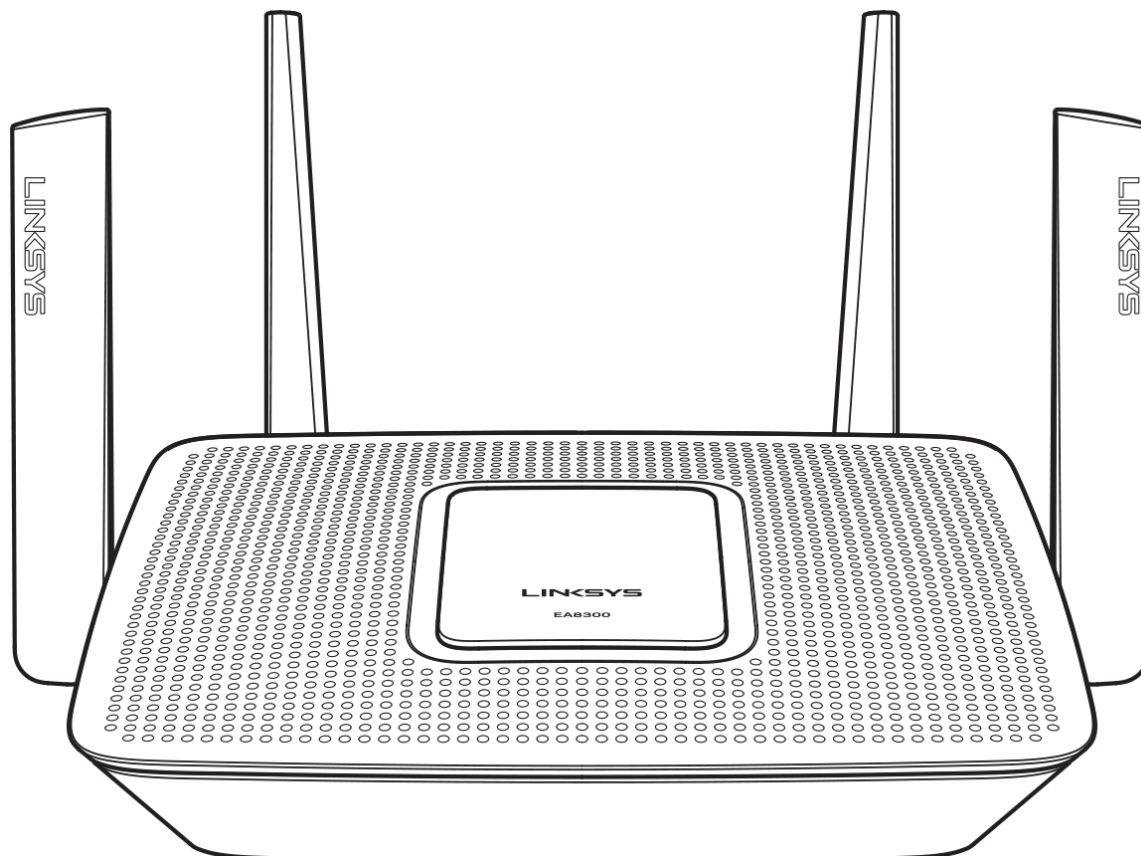



## Indikátor stavu systému

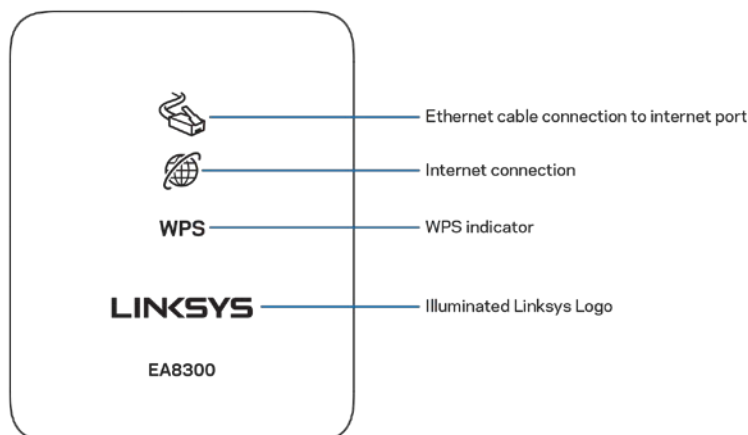

**Pripojenie sieťového kábla (ethernet) k rozhraniu Internet** — Ak svieti (oranžovo), indikuje to problém so sieťovým káblom pripojeným k rozhraniu Internet (WAN).

**Pripojenie k internetu** — Ak svieti (oranžovo), indikuje to, že smerovač nemá prístup k internetu.

**Indikátor WPS (Wi-Fi Protected Setup™)** — Indikátor WPS rozlišuje tri stavy:

<b>Nesvieti</b>	Neprebíha žiadna aktivita funkcie WPS
<b>Bliká bielou</b>	Prebieha pripájanie prostredníctvom funkcie WPS
<b>Svieti bielou</b>	Pripojenie prostredníctvom funkcie WPS úspešné; zostáva svietiť po dobu päť sekúnd
<b>Bliká oranžovou</b>	Chyba funkcie WPS; bliká po dobu jednej minúty, potom zhasne

**Osvetlené logo Linksys** — Bliká, keď prebieha spúšťanie smerovača. Ak logo svieti nepretržite bielou, smerovač je zapnutý a funguje správne.

## Podhľad zozadu

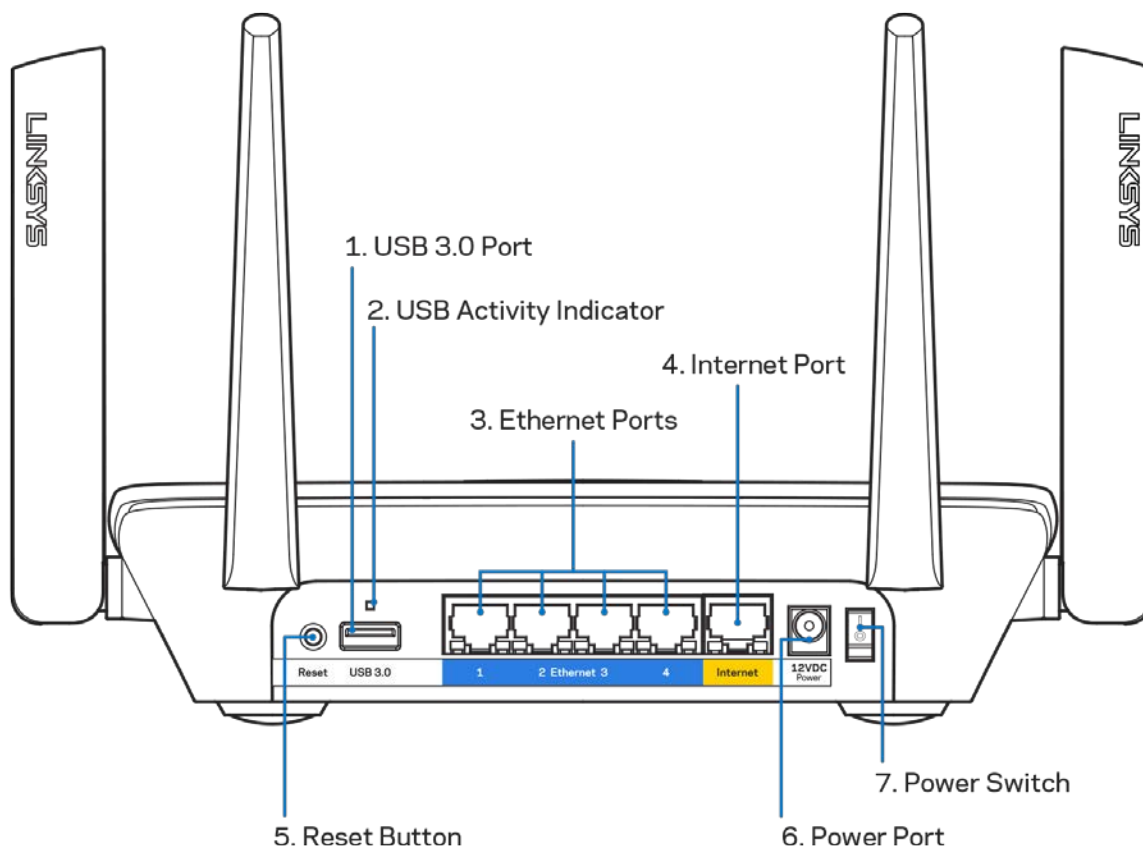

**Rozhranie USB 3.0 (1)** — Umožňuje pripojenie a zdieľanie jednotiek USB v sieti alebo na internete.

**Indikátor aktivity USB (2)** — Indikátor informuje o prenose dát do externých zariadení alebo z nich.

**Sieťové rozhrania Ethernet (3)** — Sieťovými káblami (ethernet) prepojte tieto modré gigabitové konektory (110/1100/11000) a sieťové zariadenia, ktoré chcete pripojiť káblom.

*Poznámka - Najlepší výkon rozhraní siete ethernet dosiahnete s káblami triedy CAT5e alebo vyššej.*

**Rozhranie Internet (4)** — Sieťový káblom (ethernet) prepojte tento žltý gigabitový konektor (10/100/1000) a káblový/DSL/optický modem širokopásmového internetu.

*Poznámka — Najlepší výkon rozhrania siete internet dosiahnete s káblom triedy CAT5e alebo vyššej.*

**Tlačidlo Reset (5)** — Ak chcete v smerovači obnoviť výrobné nastavenia, podržte toto tlačidlo stlačené, kým nezhasne logo Linksys. Výrobné nastavenia môžete obnoviť aj využitím služby Linksys Smart Wi-Fi prostredníctvom internetu alebo mobilnej aplikácie.

**Konektor napájania (6)** — Do tohto konektora zapojte priložený napájací adaptér.

**Hlavný vypínač (7)** — Smerovač sa zapína stlačením | (zapnuté).

## Pohľad z boku

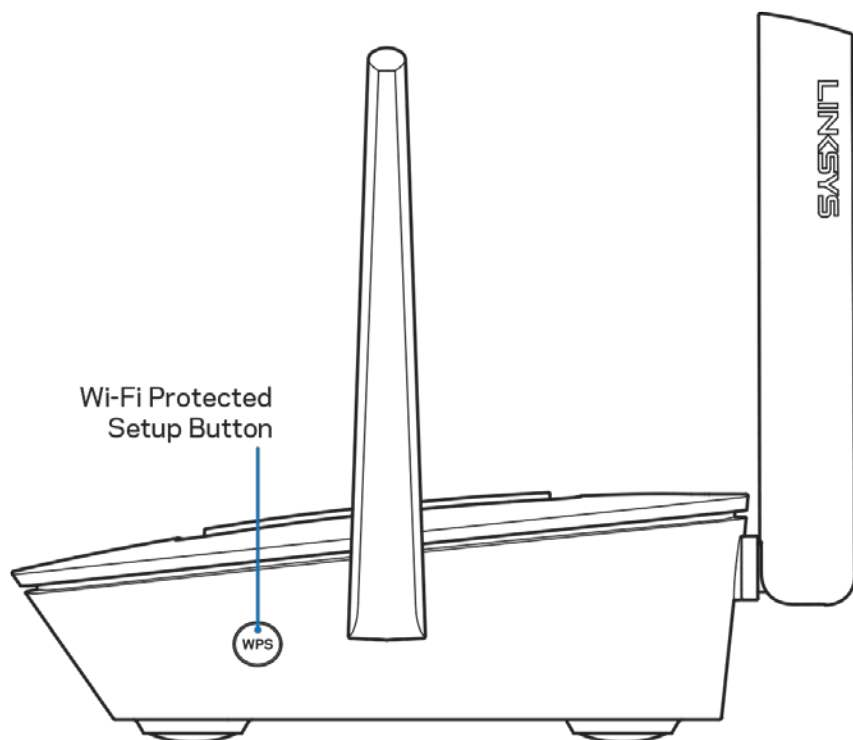

**Tlačidlo funkcie WPS (Wi-Fi Protected Setup™)** — Stlačením pripojte zariadenia podporujúce funkciu WPS.

# Nastavenie: Základy

## Získanie pomoci

Okrem tohto návodu na používanie získate ďalšie informácie z nasledujúcich zdrojov:

- [Linksys.com/support/EA8300](http://Linksys.com/support/EA8300) (dokumentácia, súbory na prevzatie, časté otázky, technická podpora, živé konverzácie, fóra)
- Pomoc služby Linksys Smart Wi-Fi (pripojte sa k Linksys Smart Wi-Fi a kliknite na položku Help (Pomoc) vo vrchnej časti okna)

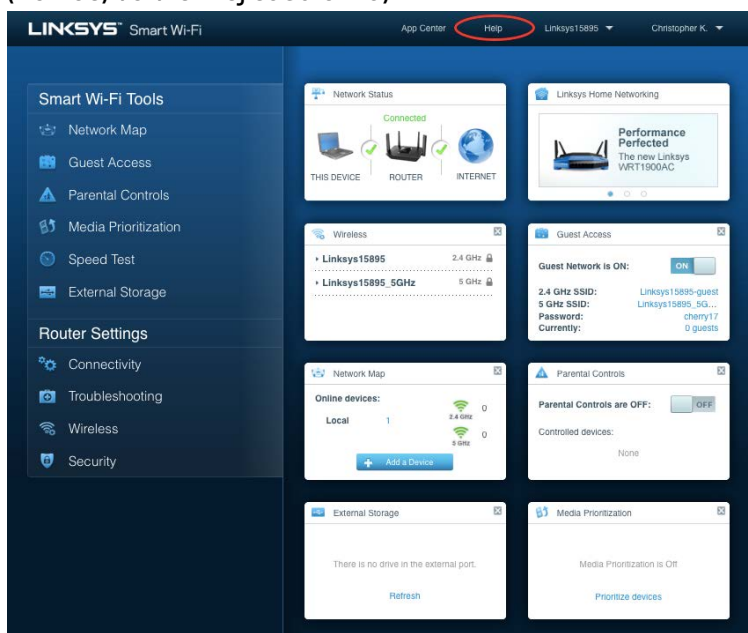

The screenshot shows the Linksys Smart Wi-Fi app interface. At the top, there is a navigation bar with 'App Center', 'Help' (highlighted with a red circle), 'Linksys15895', and 'Christopher K.'. The main interface is divided into several sections: 'Smart Wi-Fi Tools' (Network Map, Guest Access, Parental Controls, Media Prioritization, Speed Test, External Storage), 'Router Settings' (Connectivity, Troubleshooting, Wireless, Security), and a central dashboard with widgets for Network Status, Linksys Home Networking, Wireless, Guest Access, Network Map, Parental Controls, External Storage, and Media Prioritization.

**Help**

**Using Linksys Smart Wi-Fi**

Linksys Smart Wi-Fi allows you to access all of your router's features and settings. Simply click on a feature or widget you want to open.

You can use Linksys Smart Wi-Fi to:

- See what's currently connected to your network, and connect more computers and devices.
- Create a Linksys Smart Wi-Fi account to access router settings from anywhere using any browser, even when you're away from home. You can personalize your router and change settings for wireless access, Internet, gaming, local network, and more. You can even access router settings for multiple routers, which is helpful if you set up and manage more than one router. (The account is available only on EA-Series routers.)
- Allow guests in your home to use the Internet without giving them access to your network. While on the guest network, users can surf the net, but won't be able to access your printers, other computers, or devices on your network.

**Help Categories**

- Linksys Smart Wi-Fi
- Device List
- Guest Access
- Parental Controls
- Media Prioritization
- Speed Test
- External Storage
- Connectivity

Ok

**Poznámka** — Licencie a upozornenia týkajúce sa softvéru tretích strán si môžete pozrieť na lokalite <http://support.linksys.com/en-us/license>. S otázkami alebo požiadavkami týkajúcimi sa zdrojového kódu GPL sa obráťte na <http://support.linksys.com/en-us/gplcodecenter>.

## Inštalácia smerovača

1. Nastavenie dokončíte návštevou lokality <http://LinksysSmartWiFi.com> z webového prehliadača počítača.
2. Identifikujte zariadenia.

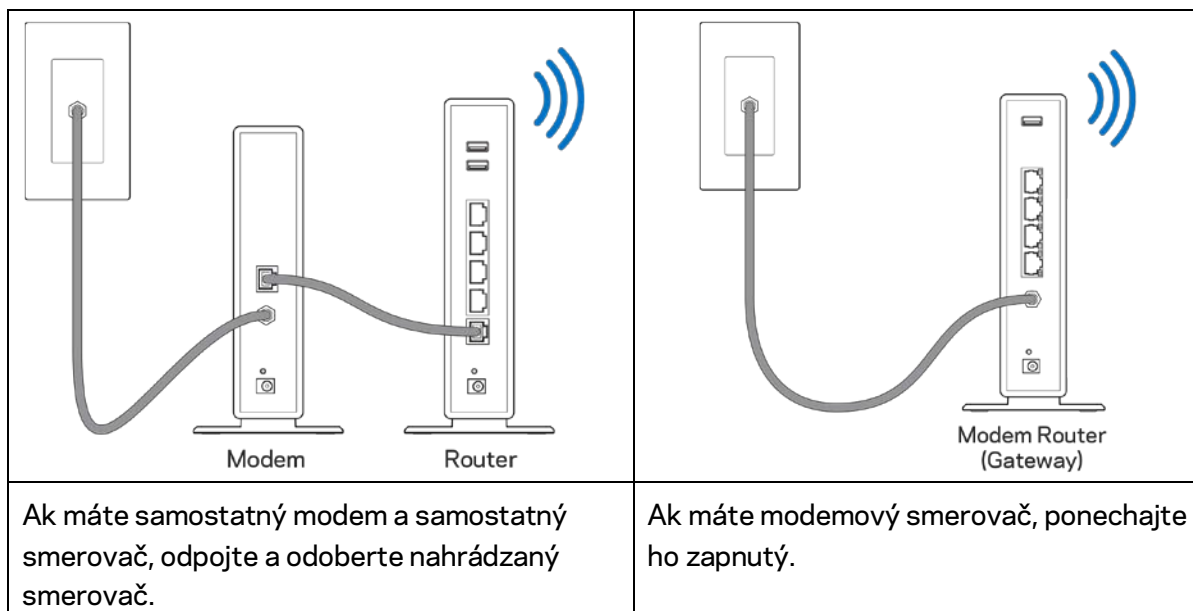

3. Namontujte antény kolmo a pripojte smerovač k elektrickej sieti. Skontrolujte, či je hlavný vypínač v polohe I (zapnuté).
4. Pripojte smerovač k modemu alebo modemovému smerovaču. Jeden konektor dodaného internetového kábla zapojte žltého konektora Internet na novom smerovači. Ak máte modem, zapojte druhý konektor do rozhrania Ethernet (LAN) na modeme. Ak máte modemový smerovač, zapojte ho do ľubovoľného dostupného rozhrania.
5. Počkajte, kým osvetlená dióda Linksys navrchu smerovača prestane blikať a začne nepretržite svietiť bielo.
6. Pripojte sa k bezdrôtovej sieti označenej názvom uvedeným v stručnom návode, ktorý je súčasťou smerovača. (Tieto údaje môžete zmeniť neskôr.) Ak potrebujete podrobnejšie informácie týkajúce sa pripojenia k sieti, navštívte [linksys.com/support/EA8300](http://linksys.com/support/EA8300).

**Poznámka -** *Kým nebude dokončená inštalácia smerovača, nebudete mať prístup k internetu.*

7. Do webového prehliadača vložte <http://LinksysSmartWiFi.com>. Inštaláciu smerovača dokončíte podľa zobrazených pokynov. Inštaláciu je možné spustiť aj napísaním 192.168.1.1 do riadka adresy prehliadača.

Po nastavení postupujte podľa zobrazených pokynov a vytvorte si konto služby Linksys Smart Wi-Fi. Službu Linksys Smart Wi-Fi môžete využiť na konfiguráciu smerovača z ľubovoľného počítača pripojeného k internetu.

Správa nastavení smerovača:

- Zmeniť názov a heslo smerovača
- Nastaviť prístup hostí
- Konfigurovať rodičovskú kontrolu
- Pripojiť zariadenia k sieti Wi-Fi
- Otestovať rýchlosť pripojenia k internetu

**Poznámka** — Pri vytváraní konta Linksys Smart Wi-Fi vám zašleme overovací email. Z domácej siete kliknite na prepojenie uvedené v tomto emaili, a tak priradíte smerovač k svojmu kontu služby Linksys Smart Wi-Fi.

**Tip** — Vytlačte si ďalšiu stránku a do nasledujúcej tabuľky si zaznamenajte nastavenia smerovača a svojho konta. Túto stránku si uložte na bezpečné miesto.

Názov siete Wi-Fi 2,4 GHz	
Heslo siete Wi-Fi	
Názov siete Wi-Fi 5 GHz <sub>1</sub>	
Heslo siete Wi-Fi	
Názov siete Wi-Fi 5 GHz <sub>2</sub>	
Heslo siete Wi-Fi	
Heslo smerovača	
Názov siete Wi-Fi pre hostí 2,4 GHz	
Názov siete Wi-Fi pre hostí 5 GHz	
Heslo siete Wi-Fi pre hostí (siete v oboch pásmach využívajú jedno heslo)	
Meno používateľa služby Linksys Smart Wi-Fi	
Heslo služby Linksys Smart Wi-Fi	

# Používanie služby Linksys Smart Wi-Fi

Použitím služby Linksys Smart Wi-Fi môžete vykonávať konfiguráciu smerovača z ľubovoľného miesta vo svete, môžete ho však konfigurovať aj priamo vo svojej domácej sieti. Služba Linksys Smart Wi-Fi môže byť dostupná aj pre mobilné zariadenia. Bližšie informácie nájdete v obchode s aplikáciami pre používané zariadenie.

## Pripojenie k službe Linksys Smart Wi-Fi

Postup pripojenia k službe Linksys Smart Wi-Fi:

1. V počítači otvorte webový prehliadač.
2. Prejdite na lokalitu <http://LinksysSmartWiFi.com> a prihláste sa k svojmu kontu.

Ak si nepamätáte svoje heslo, kliknite na *Forgot your password?* (Nepamätám si heslo) a obnovte ho podľa zobrazených pokynov.



## Mapa siete

Umožňuje zobraziť a spravovať všetky sieťové zariadenia pripojené k smerovaču. Môžete zobraziť zariadenia pripojené k hlavnej sieti a hosťovskej sieti alebo zobraziť informácie o jednotlivých zariadeniach.



## Guest Access (Prístup hostí)

Umožňuje nastaviť a monitorovať sieť Wi-Fi pre hostí, tak aby ste zamedzili prístup k svojim osobným informáciám.

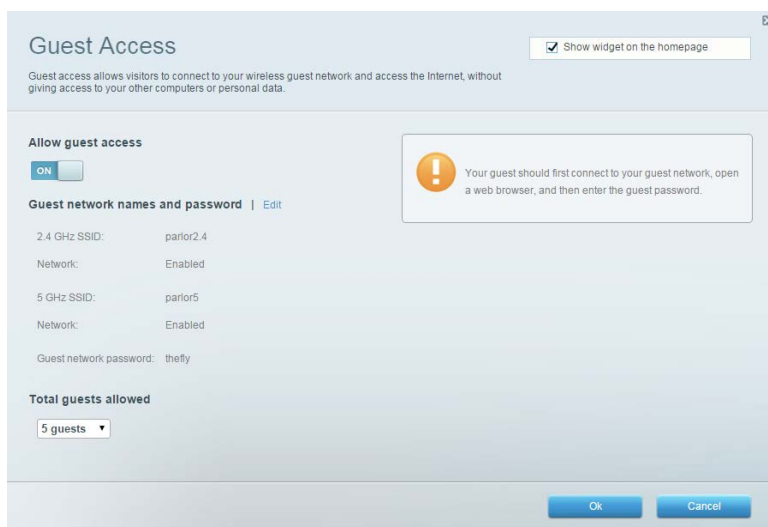

## Rodičovská kontrola (Parental Controls)

Umožňuje blokovať stránky a nastaviť dobu povoleného prístupu k internetu.

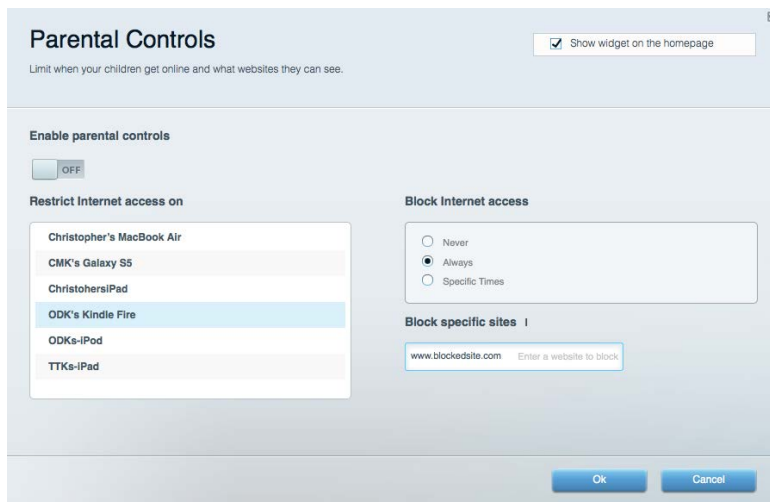

## Prioritizácia médií (Media Prioritization)

Umožňuje nastaviť zariadenia a aplikácie, ktoré budú mať prioritu pri sieťovej komunikácii.

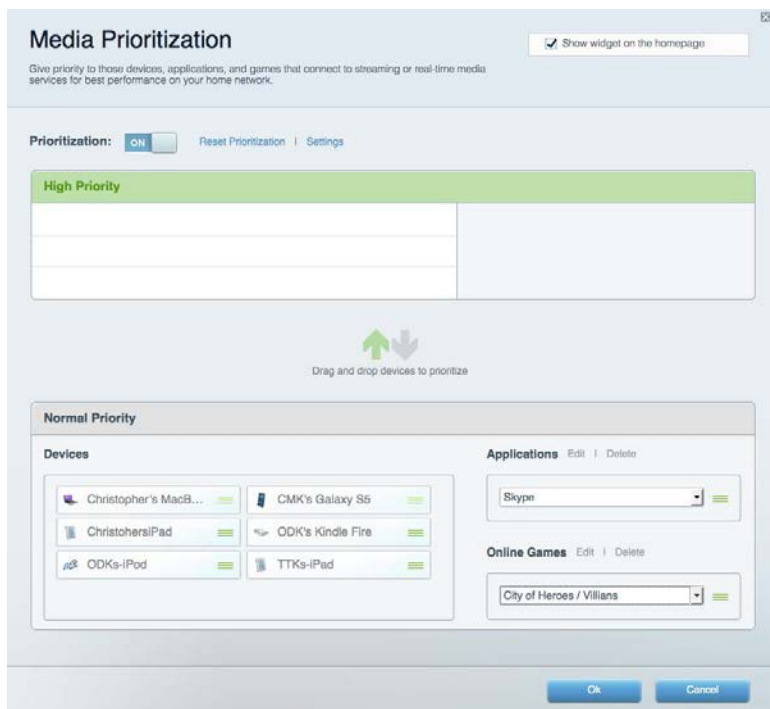

## Test rýchlosti (Speed Test)

Umožňuje otestovať rýchlosť internetového pripojenia vašej siete.



## Externé úložisko

Umožňuje prístup k pripojenej jednotke USB (nie je súčasťou balenia) a nastavenie zdieľania súborov, mediálneho servera a prístupu k FTP.



## Možnosti pripojenia (Connectivity)

Umožňuje zobraziť a zmeniť základné a rozšírené nastavenia siete.

The screenshot shows the 'Connectivity' settings page. It has a title bar with a close button and a subtitle 'View and change router settings'. Below the title bar are tabs for 'Basic', 'Internet Settings', 'Local Network', 'Advanced Routing', 'VLAN', and 'Administration'. The 'Basic' tab is selected. The page is divided into several sections: 'Network Name and Password' with fields for 2.4 GHz and 5 GHz network names and passwords; 'Router Password' with a masked password field; 'Router Firmware Update' with a checked 'Automatic' checkbox and a 'Check for Updates' button; 'Time Zone' with a dropdown menu set to '(GMT-05:00) Eastern Time (USA & Canada)' and a checked 'Automatically adjust for Daylight Savings Time' checkbox; and 'Activity Lights' with an 'ON' toggle and a text box explaining the power light status. At the bottom are 'Ok', 'Cancel', and 'Apply' buttons.

## Riešenie problémov

Umožňuje diagnostikovať problémy so smerovačom a kontrolovať stav siete.

The screenshot shows the 'Troubleshooting' page. It has a title bar with a close button and a subtitle 'Troubleshoot router settings'. Below the title bar are tabs for 'Status', 'Diagnostics', and 'Logs'. The 'Diagnostics' tab is selected. The page is divided into several sections: 'Ping IPv4' with input fields for IP or host name and number of pings, and a 'Start to Ping' button; 'Trace route' with an input field for IP or host name and a 'Start to Traceroute' button; 'Reboot' with a 'Reboot the router' link; 'Router configuration' with 'Backup' and 'Restore' buttons; 'Router Firmware' with a 'Restore previous firmware' button; 'Internet Address' showing IPv4 and IPv6 addresses with 'Release and Renew' links; and 'Factory reset' with a 'Reset to factory default settings' link. At the bottom is an 'Ok' button.

## Bezdrôtová sieť (Wireless)

Umožňuje zobraziť a zmeniť bezdrôtovú sieť smerovača. Umožňuje zmeniť názvy sietí, režim zabezpečenia, heslo, filtrovanie adres MAC a pripojiť zariadenia prostredníctvom funkcie Wi-Fi Protected Setup.

The screenshot shows the 'Wireless' settings page. At the top, there is a checkbox for 'Show widget on the homepage' which is checked. Below this, there are tabs for 'Wireless', 'MAC Filtering', and 'Wi-Fi Protected Setup'. The 'Smart Connect' section has two radio buttons: '5 GHz band steering' (selected) and 'Off'. Below this, there are two network configuration sections. The first section is for the 2.4 GHz network, with the name 'arachnid' and a 'Network' toggle set to 'ON'. The second section is for the 5 GHz network, with the name 'arachnid\_5GHz' and a 'Network' toggle set to 'ON'. Both sections include fields for 'Password', 'Broadcast SSID', 'Channel', 'Security mode', and 'Channel width'. At the bottom of the page, there are 'Ok', 'Cancel', and 'Apply' buttons.

## Zabezpečenie (Security)

Umožňuje zobraziť a zmeniť zabezpečenie bezdrôtovej siete smerovača. Umožňuje nastaviť bránu firewall, nastavenia VPN a vykonať vlastné nastavenia aplikácií a hier.

The screenshot shows the 'Security' settings page. At the top, there are tabs for 'Firewall', 'DMZ', and 'Apps and Gaming'. The 'Firewall' section is active and contains several sub-sections: 'Firewall' with 'IPv4 SPI firewall protection' and 'IPv6 SPI firewall protection' both checked and 'Enabled'; 'VPN Passthrough' with 'IPSec Passthrough', 'PPTP Passthrough', and 'L2TP Passthrough' all checked and 'Enabled'; and 'Internet filters' with 'Filter anonymous Internet requests' checked, 'Filter multicast' unchecked, 'Filter Internet NAT redirection' unchecked, and 'Filter ident (Port 113)' checked. Below these sections is an 'IPv6 Port Services' table with columns for 'Description', 'Protocol', 'IPv6 Address', 'Allow', and 'Enabled'. At the bottom of the page, there are 'Ok', 'Cancel', and 'Apply' buttons.

# Riešenie problémov

Ďalšiu pomoc nájdete v našom oceňovanom centre služieb zákazníkom na lokalite [linksys.com/support/EA8300](http://linksys.com/support/EA8300).

## Your router was not successfully set up (Inštalácia smerovača nebola úspešná)

Ak služba Linksys Smart Wi-Fi nedokončí nastavenie, vyskúšajte nasledujúci postup:

- Kancelárskou spinkou alebo špendlíkom podržte stlačené tlačidlo Reset na smerovači, kým nezhasne svietiace logo Linksys a nezačnú blikať modré indikátory MU-MIMO (približne 10 sekúnd). Znova vykonajte inštaláciu smerovača.

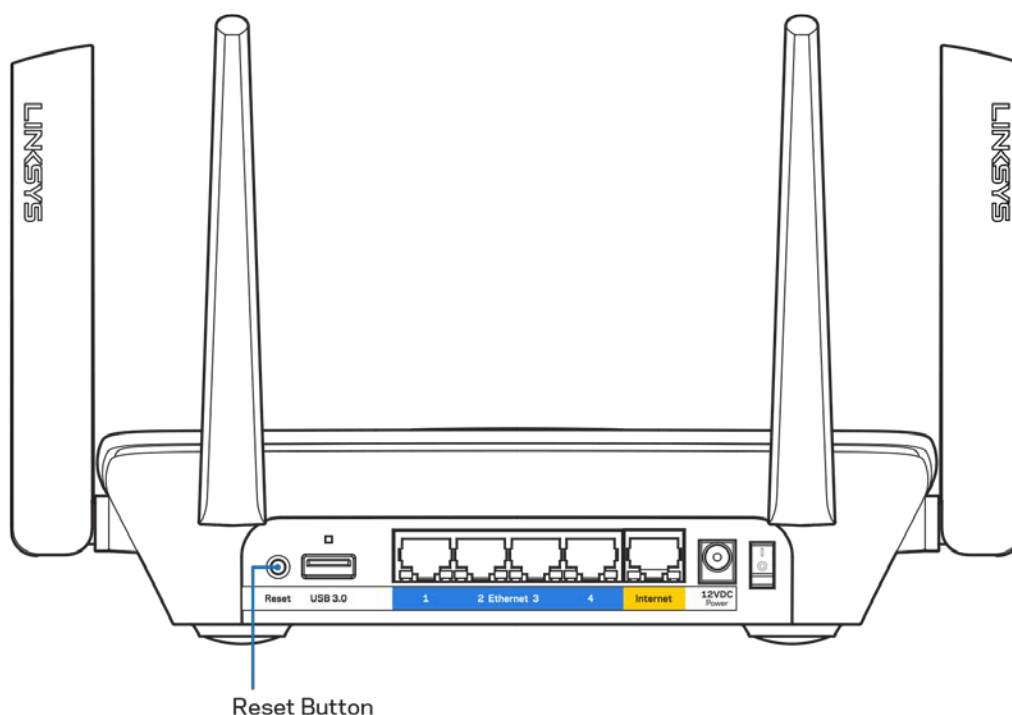

- Dočasne deaktivujte bránu firewall počítača (informácie o postupe nájdete pokynoch k zabezpečovaciemu softvéru). Znova vykonajte inštaláciu smerovača.
- Ak máte k dispozícii ďalší počítač, skúste nainštalovať smerovač z neho.

## Hlásenie *Your Internet cable is not plugged in* (Internetový kábel nie je pripojený)

Ak sa počas nastavovania smerovača zobrazí hlásenie Internetový kábel nie je pripojený, postupujte podľa nasledujúcich krokov.

- Skontrolujte, či je kábel siete ethernet alebo internet (alebo kábel podobný tomu, ktorý bol súčasťou smerovača) riadne pripojený k žltému rozhraniu Internet na zadnej strane smerovača a k príslušnému rozhraniu modemu. Toto rozhranie je na modeme zvyčajne označené ako Ethernet.

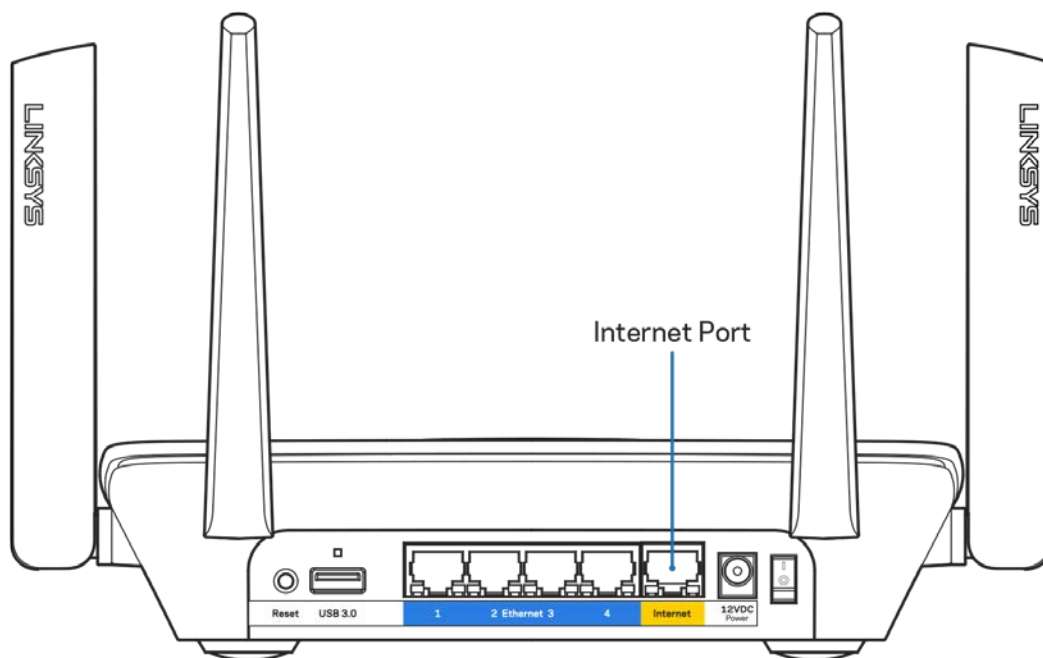

- Skontrolujte, či je modem pripojený k elektrickej sieti a zapnutý. Ak je na modeme hlavný vypínač, skontrolujte, či je zapnutý - poloha ON (zapnuté) alebo I (poloha vypnutia je O).

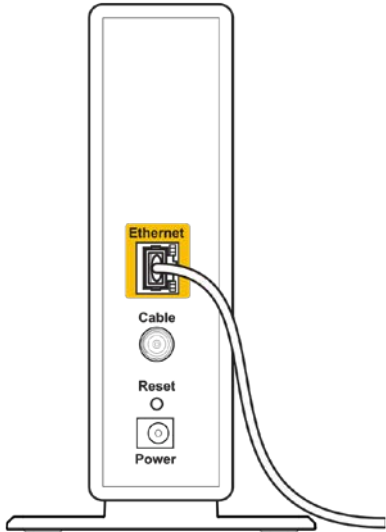
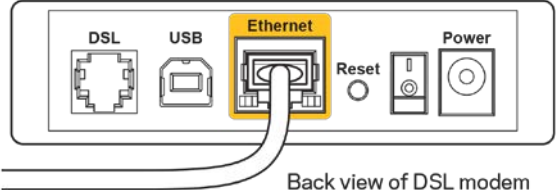
 <p>Back view of cable modem</p>	 <p>Back view of DSL modem</p>
<p>Ak používate káblové pripojenie k internetu, skontrolujte, či je k rozhraniu CABLE káblového modemu pripojený koaxiálny kábel rozvodu poskytovateľa internetových služieb (ISP).</p>	<p>Ak na pripojenie k internetu používate DSL, skontrolujte, či je telefónna linka DSL pripojená k rozhraniu modemu DSL.</p>

- Ak bol počítač predtým pripojený k modemu káblom USB, odpojte kábel USB.
- Znova vykonajte inštaláciu smerovača.

## Hlásenie *Cannot access your router* (Nie je možný prístup k smerovaču)

Aby ste získali prístup k smerovaču, musíte sa pripojiť k vlastnej sieti. Ak na prístup k internetu využívate bezdrôtové pripojenie, problém môže byť v tom, že ste sa omylom pripojili k inej bezdrôtovej sieti.

Vyriešenie problému na počítačoch so systémom Windows\*:

1. Kliknite na ikonu bezdrôtovej siete zobrazenej na paneli úloh. Zobrazí sa zoznam bezdrôtových sietí.



2. Kliknite na názov svojej siete. Kliknite na Connect (Pripojiť). V nasledujúcom príklade je počítač pripojený k inej bezdrôtovej sieti s názvom wraith\_5GHz. V tomto príklade je zvolená bezdrôtová sieť smerovača Linksys EA8300 s názvom Damaged\_Beez2.4.



3. Ak sa zobrazí výzva na vloženie kľúča zabezpečenia siete, vložte heslo (kľúč zabezpečenia) do poľa kľúča zabezpečenia siete. Kliknite na tlačidlo OK.
4. Počítač sa pripojí k sieti a vy sa budete môcť pripojiť k smerovaču.

*\* Konkrétna podoba hlásení alebo ikon pri týchto krokoch závisí od používanej verzie systému Windows.*

Vyriešenie problému na počítačoch so systémom Mac:

1. Na lište menu v hornej časti okna kliknite na ikonu bezdrôtovej siete. Zobrazí sa zoznam bezdrôtových sietí.
2. V nasledujúcom príklade je počítač pripojený k inej bezdrôtovej sieti s názvom wraith\_5GHz. V tomto príklade je zvolená bezdrôtová sieť smerovača Linksys EA8300 s názvom Damaged\_Beez2.4.



3. Kliknite na názov bezdrôtovej siete smerovača Linksys EA8300 (v tomto prípade Damaged\_Beez2.4).
4. Do poľa *Password* (Heslo) napíšte heslo (kľúč zabezpečenia) bezdrôtovej siete. Kliknite na tlačidlo **OK**.

## Po inštalácii

### Nie je dostupná sieť internet

Ak sa vyskytol problém komunikácie medzi internetom a smerovačom, vo webovom prehliadači sa môže zobrazíť správa Nepodarilo sa nájsť [internetová adresa]. Ak viete, že internetová adresa je správna a bez úspechu ste vyskúšali vložiť niekoľko platných internetových adries, táto správa môže znamenať, že došlo k problémom komunikácie medzi poskytovateľom internetových služieb (ISP) alebo modemom a smerovačom. Vyskúšajte nasledujúci postup:

- Skontrolujte, či je správne pripojený sieťový a napájací kábel.
- Skontrolujte, či funguje napájanie zásuvky, do ktorej je zapojený smerovač.
- Reštartujte smerovač.
- Kontaktujte poskytovateľa internetových služieb (ISP) a informujte sa o výpadkoch internetu vo vašej oblasti.

Najbežnejším spôsobom riešenia problémov so smerovačom je jeho vypnutie a opätovné zapnutie. Smerovač pritom znova načíta vlastné nastavenia a ostatné zariadenia (napr. modem) budú môcť znova detegovať smerovač a komunikovať s ním. Tento proces sa nazýva reštartovanie.

Reštartovanie smerovača použitím napájacieho kábla:

1. Odpojte napájací kábel smerovača a modemu.
2. Počkajte 10 sekúnd a znova pripojte napájací kábel do modemu. Skontrolujte, či funguje napájanie.
3. Počkajte, kým indikátor stavu online modemu neprestane blikať (približne dve minúty). Opäť pripojte napájací kábel k smerovaču.
4. Počkajte, kým sa nerozsvieti logo Linksys. Počkajte dve minúty a až potom sa skúste pripojiť k internetu z počítača.

Reštartovanie smerovača použitím služby Linksys Smart Wi-Fi:

1. Prihláste sa k službe Linksys Smart Wi-Fi. (Pozrite časť Pripojenie k službe Linksys Smart Wi-Fi, strana [11](#).)
2. V ponuke *Router Settings* (Nastavenia smerovača) kliknite na položku *Troubleshooting* (Riešenie problémov).
3. Kliknite na kartu *Diagnostics* (Diagnostika).
4. V položke *Reboot* (*Reštartovať*) kliknite na *Reboot* (Reštartovať).



5. Kliknite na **Yes** (Áno). Smerovač sa reštartuje. Počas reštartovania smerovača budú všetky pripojené zariadenia odpojené od internetu a automaticky sa znova pripoja, keď bude smerovač opäť pripravený.

## Vo webovom prehliadači sa neotvorí služba Linksys Smart Wi-Fi

Najnovšie verzie prehliadačov Google Chrome™, Firefox®, Safari® (pre Mac® a iPad®), Microsoft Edge a Internet Explorer® verzia 8 a novšie fungujú so službou Linksys Smart Wi-Fi.

# Technické údaje

## Linksys EA8300

Názov modelu	Troj pásomový smerovač Max-Stream AC2200 MU-MIMO
Číslo modelu	EA8300
Rýchlosť rozhrania	10/100/1000 Mb/s (gigabitový Ethernet)
Frekvencia signálu	2,4 GHz a 5 GHz (2x)
Počet antén	4 nastaviteľné externé antény (bez možnosti odobratia)
Rozhrania	USB 3.0, Ethernet (1 - 4), Internet, napájanie
Tlačidlá	WPS (Wi-Fi Protected Setup), napájanie, Reset
Indikátory	<b>Vrchný panel:</b> Osvetlené logo Linksys, Wi-Fi Protected Setup, pripojenie k sieti Internet, pripojenie sieťového kábla k rozhraniu internet <b>Zadný panel:</b> USB, Ethernet (1 - 4), Internet
UPnP	Podporované
zabezpečenie	WEP, WPA2, RADIUS
Bezpečnostný kľúč	Šifrovanie max. 128-bit.
Podpora súborových systémov ukladania	FAT, NTFS a HFS+
Podporované prehliadača	Najnovšie verzie prehliadačov Google Chrome™, Firefox®, Safari® (pre Mac® a iPad®), Microsoft Edge a Internet Explorer® verzia 8 a novšie

## Fyzické

rozmery	213,7 mm x 161,8 mm x 54,8 mm (bez antén)
Hmotnosť	608 g
Napájanie	12 V, 2A
Certifikácia	FCC, IC, CE, Wi-Fi (a/b/g/n/ac)
Prevádzková teplota	32 až 104 °F (0 až 40 °C)
Skladovacia teplota	-20 až 60 °C (-4 až 140 °F)
Prevádzková vlhkosť	Relatívna vlhkosť 10 % až 80 %, nekondenzujúca
Skladovacia vlhkosť	5 % až 90% nekondenzujúca

Špecifikácie sa môžu zmeniť bez predchádzajúceho upozornenia.

Poznámky:

Regulačné informácie, informácie o záruke a bezpečnostné informácie nájdete na disku CD, ktorý je súčasťou balenia smerovača, alebo navštívte lokalitu [Linksys.com/support/EA8300](http://Linksys.com/support/EA8300).

Maximálny výkon je odvodený od špecifikácií normy IEEE 802.11. Skutočný výkon sa môže líšiť, vrátane poklesu kapacity bezdrôtovej siete, dátového toku, rozsahu a pokrytia. Výkon závisí od mnohých faktorov, podmienok a premenných vrátane vzdialenosti od prístupového bodu, objemu sieťovej prevádzky, stavebných materiálov a konštrukcie budovy, použitého operačného systému, kombinácie použitých bezdrôtových produktov, interferencie a iných nepriaznivých podmienok.

BELKIN, LINKSYS a mnohé iné názvy produktov a logá sú obchodnými známkami skupiny spoločností Belkin. Uvedené obchodné známky tretej strany sú majetkom príslušných vlastníkov. Licencie a upozornenia týkajúce sa softvéru tretích strán si môžete pozrieť na: <http://support.linksys.com/en-us/license>. S otázkami alebo požiadavkami týkajúcimi sa zdrojového kódu GPL sa obráťte na <http://support.linksys.com/en-us/gplcodecenter>.

© 2017 Belkin International, Inc. a/alebo jej dcérske spoločnosti. Všetky práva vyhradené.

**LINKSYS®**

Navodila za uporabo

**MAX-STREAM™**

**AC2200 MU-MIMO**

**TRIPASOVNI USMERJEVALNIK**

Model EA8300

# Kazalo

<b>Pregled izdelka</b> .....	<b>3</b>
Pogled z zgornje strani .....	3
Indikator stanja sistema .....	4
Pogled od zadaj .....	5
Stranski pogled .....	6
<b>Nastavitev: Osnove</b> .....	<b>7</b>
Iskanje dodatne pomoči.....	7
Namestitev usmerjevalnika.....	8
<b>Kako uporabljati Linksys Smart Wi-Fi</b> .....	<b>11</b>
Povezovanje z Linksys Smart Wi-Fi.....	11
Zemljevid omrežja .....	12
Dostop za goste .....	12
Starševski nadzor.....	13
Prednostni vrstni red medijev .....	13
Preskus hitrosti .....	14
Zunanji pomnilnik.....	14
Povezljivost.....	15
Odpravljanje napak .....	15
Brezžična povezava.....	16
Varnost.....	16
<b>Odpravljanje napak</b> .....	<b>17</b>
Usmerjevalnik ni bil uspešno nastavljen.....	17
Sporočilo, <i>da internetni kabel ni priklopljen</i> . .....	18
Sporočilo, <i>da dostop do usmerjevalnika ni mogoč</i> .....	19
Po nastavitvi.....	21
Videti je, da internet ni na voljo .....	21
Linksys Smart Wi-Fi se ne odpre v vašem spletnem brskalniku .....	22
<b>Specifikacije</b> .....	<b>23</b>
Linksys EA8300 .....	23
Okoljski podatki.....	23

# Pregled izdelka

## Pogled z zgornje strani

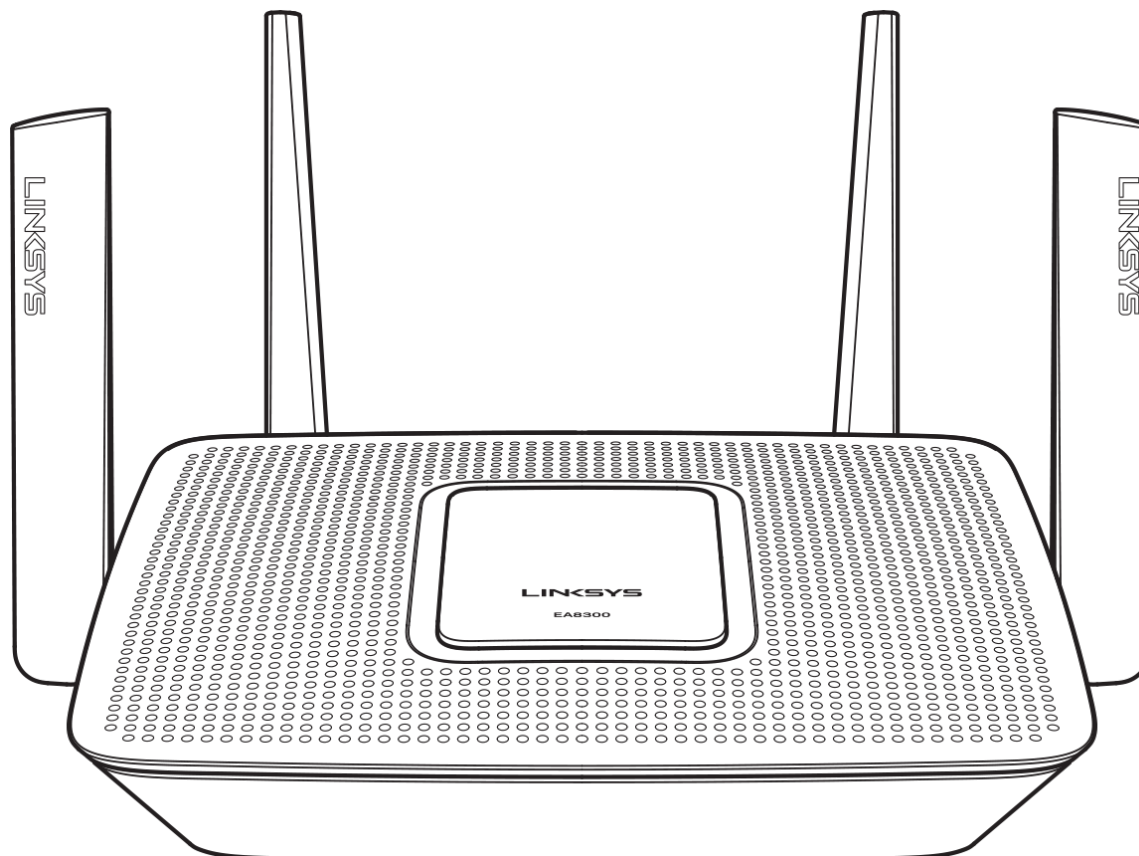



## Indikator stanja sistema

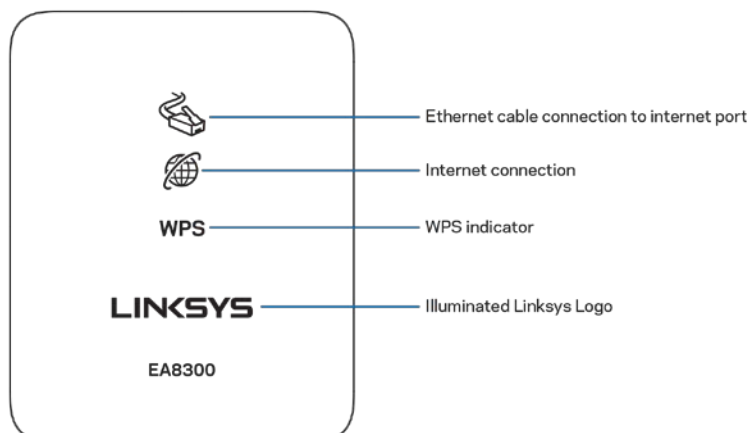

**Povezava ethernetnega kabla z internetnimi vrati**—ko sveti (oranžno), označuje težave z omrežnim kablom, priključenim v internetna (WAN) vrata.

**Internetna povezava** —ko sveti (oranžno), označuje, da usmerjevalnik nima dostop do interneta.

**Indikator WPS (Wi-Fi Protected Setup™)** —lučka WPS ima štiri stanja:

<b>Izklopljeno</b>	Wi-Fi Protected Setup ni aktiven.
<b>Utripa belo</b>	Wi-Fi Protected Setup v teku.
<b>Sveti belo</b>	Wi-Fi Protected Setup uspešno deluje; sveti pet sekund.
<b>Utripa oranžno.</b>	Napaka funkcije Wi-Fi Protected Setup; eno minuto utripa in nato ugasne.

**Osvetljen logotip Linksys**—med zaganjanjem usmerjevalnika utripa logotip. Ko logotip sveti belo, je usmerjevalnik vključen in pravilno deluje.

## Pogled od zadaj

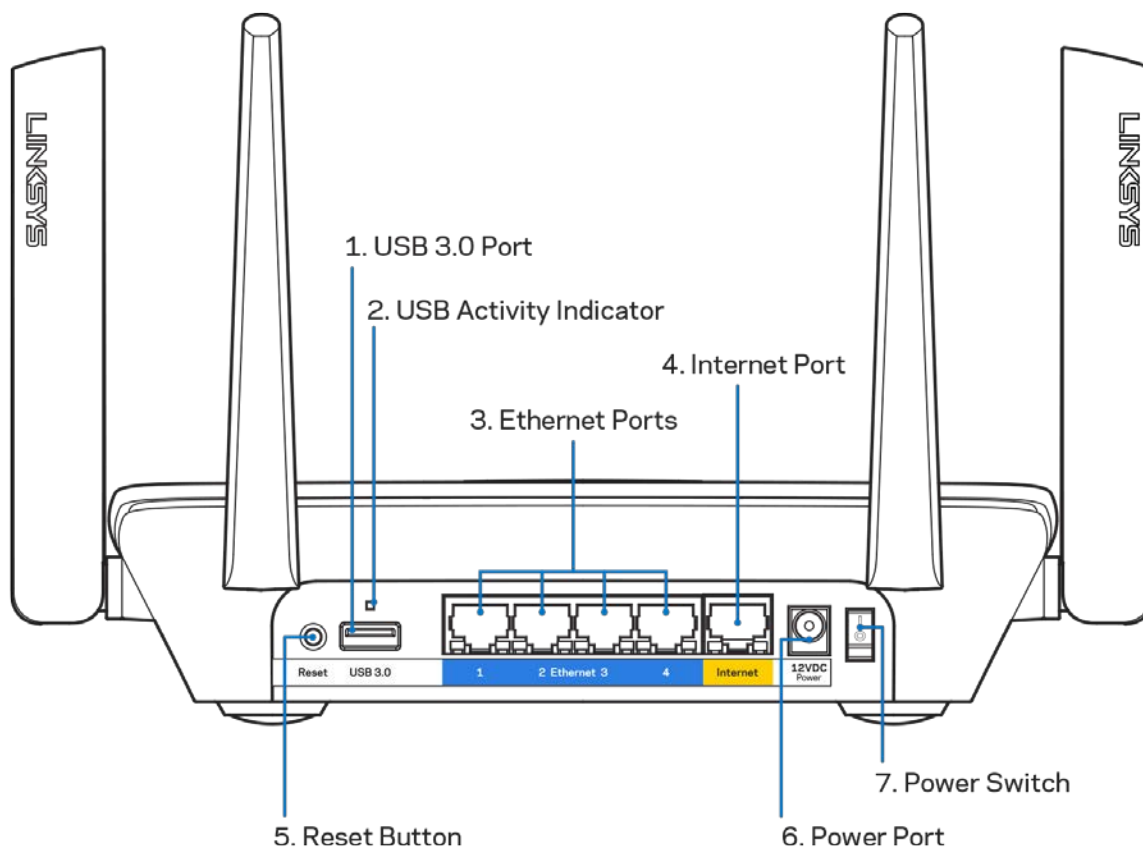

**Vrata USB 3.0 (1)**—Povežite in delite USB-pogon na svojem omrežju ali spletu.

**Indikator za aktivnost USB-ja (2)**—lučke prikazujejo prenos podatkov na/od zunanjih naprav.

**Ethernet vrata (3)**— Povežite ethernetne kable na ta hitra gigabitna vrata (10/100/1000) modre barve in na ožičene naprave na vašem omrežju.

Za najboljše delovanje v ethernetna vrata priključite kable razreda CAT5e ali višje.

**Internetna vrata (4)**—Povežite ethernetni kabel na ta rumena gigabitna (10/100/1000) vrata in na širokopasovni internetni kabel/DSL ali optični modem.

**Opomba**—Za najboljše delovanje v ethernetna vrata priključite kable razreda CAT5e ali višje.

**Gumb za ponastavitev(5)**—Pritisnite in zadržite, dokler osvetljeni logotip Linksys ne ugasne, da ponastavite usmerjevalnik na tovarniško privzete nastavitve. Tovarniške nastavitve lahko obnovite tudi s funkcijo Linksys Smart Wi-Fi na internetu ali mobilni aplikaciji.

**Vrata za napajanje(6)**— priključite priložen električni polnilnik.

**Stikalo za vklop (7)**—Pritisnite | (vklop), da vklopite usmerjevalnik.

## Stranski pogled

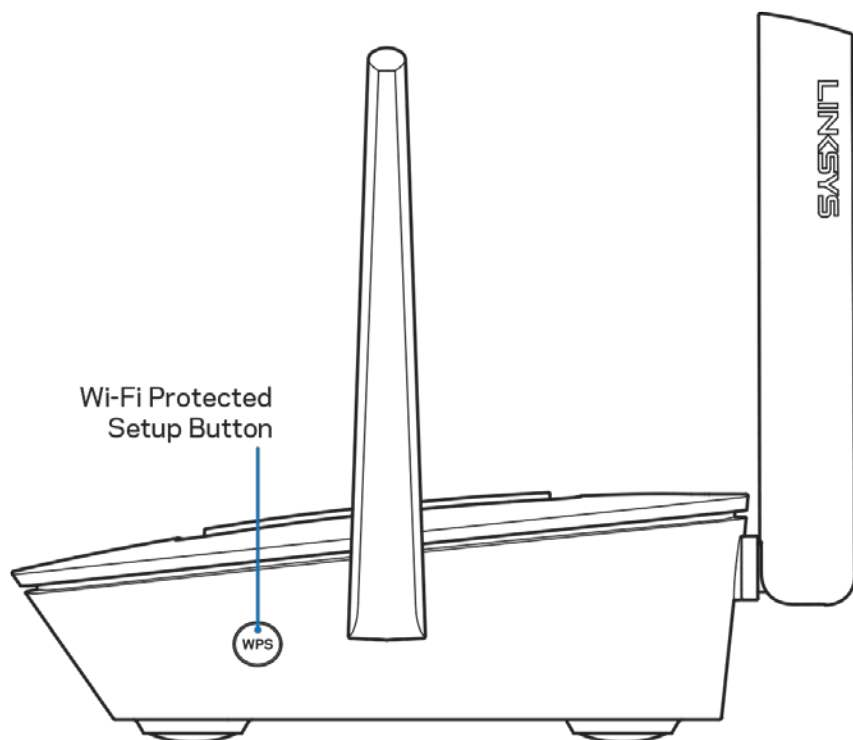

**Gumb Wi-Fi Protected Setup™** —pritisnite, da povežete omrežne naprave, omogočene za WPS.

# Nastavitev: Osnove

## Iskanje dodatne pomoči

Poleg teh navodil za uporabo lahko najdete pomoč na naslednjih mestih:

- [Linksys.com/support/EA8300](http://Linksys.com/support/EA8300) (dokumentacija, prenosi, pogosta vprašanja, tehnična podpora, pogovor v živo, forumi)
- Linksys Smart Wi-Fi pomoč (povežite se z Linksys Smart Wi-Fi, nato pa na vrhu zaslona kliknite Pomoč)

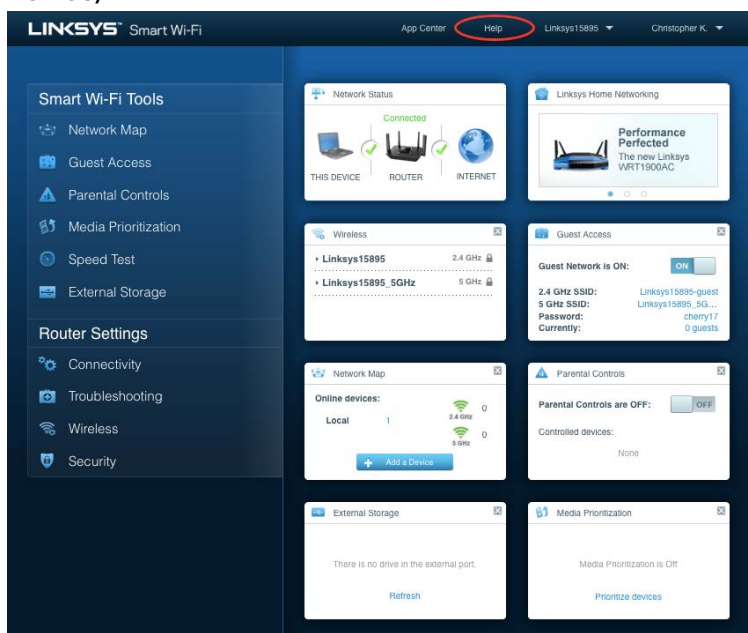

The screenshot shows the Linksys Smart Wi-Fi web interface. The top navigation bar includes 'App Center', 'Help' (highlighted with a red circle), 'Linksys15895', and 'Christopher K.'. The main content area is divided into several sections: 'Smart Wi-Fi Tools' (Network Map, Guest Access, Parental Controls, Media Prioritization, Speed Test, External Storage), 'Router Settings' (Connectivity, Troubleshooting, Wireless, Security), and various status widgets (Network Status, Linksys Home Networking, Wireless, Guest Access, Network Map, Parental Controls, External Storage, Media Prioritization).

### Help

**Using Linksys Smart Wi-Fi**

Linksys Smart Wi-Fi allows you to access all of your router's features and settings. Simply click on a feature or widget you want to open.

You can use Linksys Smart Wi-Fi to:

- See what's currently connected to your network, and connect more computers and devices.
- Create a Linksys Smart Wi-Fi account to access router settings from anywhere using any browser, even when you're away from home. You can personalize your router and change settings for wireless access, Internet, gaming, local network, and more. You can even access router settings for multiple routers, which is helpful if you set up and manage more than one router. (The account is available only on EA-Series routers.)
- Allow guests in your home to use the Internet without giving them access to your network. While on the guest network, users can surf the net, but won't be able to access your printers, other computers, or devices on your network.

**Help Categories**

- Linksys Smart Wi-Fi
- Device List
- Guest Access
- Parental Controls
- Media Prioritization
- Speed Test
- External Storage
- Connectivity

Ok

**Opomba—Licence in obvestila za programsko opremo neodvisnih izdelovalcev, uporabljeno v tem izdelku, si lahko ogledate na <http://support.linksys.com/en-us/license>. Za vprašanja ali zahteve za izvorne kode GPL se obrnite na <http://support.linksys.com/en-us/gplcodecenter>.**

## Namestitev usmerjevalnika

1. Za zaključite nastavitve, morate na računalniku obiskati <http://LinksysSmartWiFi.com>.
2. Identificirajte svojo opremo.

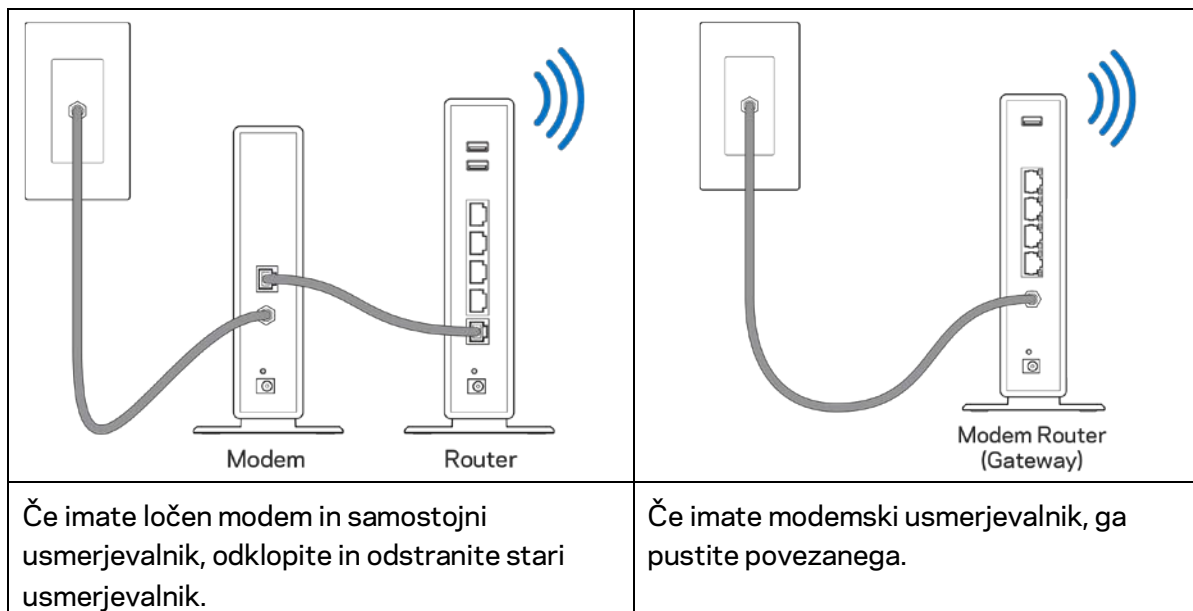

3. Postavite anteni naravnost navzgor in priključite usmerjevalnik v vir napajanja. Zagotovite, da je stikalo za vklop na položaju I (vklop).
4. Povežite usmerjevalnik z modemom ali modemske usmerjevalnikom. Priključite en konec priloženega internetnega kabla v rumena vrata za internet na novem usmerjevalniku. Če imate modem, priključite drugi konec v vrata Ethernet (LAN) na modemu. Če imate modemske usmerjevalnik, ga priključite v katerakoli prosta vrata.
5. Počakajte, da osvetljena lučka Linksys na vrhu usmerjevalnika preneha utripati in začne svetiti.
6. Povežite se na ime brezžičnega omrežja, prikazano v Hitrem priročniku, priloženem vašemu usmerjevalniku. (Te podrobnosti lahko pozneje spremenite.) Če potrebujete pomoč pri povezovanju v omrežje, glejte dokumentacijo naprave na [linksys.com/support/ea8300](http://linksys.com/support/ea8300).

**Opomba**—Dokler namestitev ni dokončana, ne boste imeli dostopa do interneta.

7. V spletni brskalnik vnesite <http://LinksysSmartWiFi.com>. Sledite navodilom na zaslonu, da zaključite z nastavitvijo usmerjevalnika. Za začetek nastavitve lahko v brskalnik vnesete tudi 192.168.1.1.

Po koncu namestitve sledite navodilom na zaslonu, da nastavite račun za Linksys Smart Wi-Fi. S pomočjo Linksys Smart Wi-Fi konfigurirajte usmerjevalnik s katerega koli računalnika z internetno povezavo.

Upravljajte nastavitve svojega usmerjevalnika:

- Spreminjate ime in geslo usmerjevalnika
- Nastavite dostop za goste
- Konfigurirate starševski nadzor
- Naprave povežete s svojim brezžičnim omrežjem
- Preizkusite hitrost internetne povezave

**Opomba**—Kot del nastavitve računa za Linksys Smart Wi-Fi boste prejeli potrditveno e-poštno sporočilo. Iz svojega domačega omrežja kliknite na povezavo v e-pošti, da usmerjevalnik povežete z računom Linksys Smart Wi-Fi.

**Namig**—Natisnite naslednjo stran, nato pa v tabelo napišite nastavitve svojega usmerjevalnika in računa. Zapiske spravite na varno.

Ime 2,4-gigaherčnega brezžičnega omrežja	
Geslo za brezžično omrežje	
Ime 5-gigaherčnega <sup>1</sup> brezžičnega omrežja	
Geslo za brezžično omrežje	
Ime 5-gigaherčnega <sup>2</sup> brezžičnega omrežja	
Geslo za brezžično omrežje	
Geslo usmerjevalnika	
Ime gostujočega 2,4-gigaherčnega brezžičnega omrežja	
Ime gostujočega 5-gigaherčnega brezžičnega omrežja	
Geslo za gosta za brezžično omrežje (oba si delita geslo)	
Uporabniško ime za Linksys Smart Wi-Fi	
Geslo za Linksys Smart Wi-Fi	

# Kako uporabljati Linksys Smart Wi-Fi

Usmerjevalnik lahko upravljate od koder koli na svetu prek možnosti Linksys Smart Wi-Fi, lahko pa ga konfigurirate tudi neposredno na svojem domačem omrežju. Linksys Smart Wi-Fi je morda na voljo tudi za vašo mobilno napravo. Za informacije glejte prodajalno aplikacij na vaši napravi.

## Povezovanje z Linksys Smart Wi-Fi

Za povezavo z Linksys Smart Wi-Fi:

1. Odprite spletni brskalnik svojega računalnika.
2. Obiščite <http://LinksysSmartWiFi.com> in se prijavite v svoj račun.

Linksys Smart Wi-Fi Sign In

If you have not yet created a Linksys Smart Wi-Fi account, click the "Create Account" button in the upper right corner of the page.

Give guests Internet access

Use your Linksys Smart Wi-Fi account to access your home network from anywhere, at any time, even from your mobile device. Easily connect new devices, set parental controls, get access to Smart Wi-Fi mobile Apps, and more.

For more information [click here](#)

English (United States)

For local access, [click here](#).

Če ste pozabili geslo, kliknite na *Forgot your password?* (Pozabili geslo?) in sledite navodilom na zaslonu, da ga obnovite.



## Zemljevid omrežja

Omogoča vam prikaz in upravljanje vseh omrežnih naprav, ki so povezane z usmerjevalnikom. Ogledate si lahko naprave v glavnem in gostujočem omrežju ali prikažete informacije o kateri koli napravi.



## Dostop za goste

Omogoča vam nastaviti in spremljati brezžično omrežje za goste, ne da bi pri tem izpostavili svoje osebne informacije.

The screenshot shows the 'Guest Access' configuration interface. At the top, there is a checkbox 'Show widget on the homepage' which is checked. Below this, there is a section 'Allow guest access' with a toggle switch set to 'ON'. To the right of this section is a warning box with an exclamation mark icon and the text: 'Your guest should first connect to your guest network, open a web browser, and then enter the guest password.' Below the 'Allow guest access' section is a section 'Guest network names and password' with an 'Edit' link. This section contains two rows of settings: '2.4 GHz SSID: parlor2.4' and 'Network: Enabled'; '5 GHz SSID: parlor5' and 'Network: Enabled'. Below this is a field for 'Guest network password: thefly'. At the bottom, there is a section 'Total guests allowed' with a dropdown menu set to '5 guests'. 'Ok' and 'Cancel' buttons are located at the bottom right of the interface.

## Starševski nadzor

Omogoča vam blokirati spletna mesta in nastavljati čase za dostop do interneta.

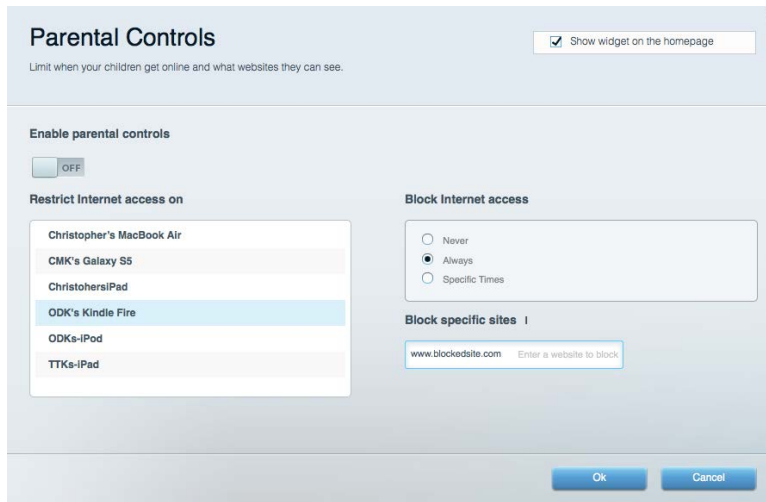

## Prednostni vrstni red medijev

Omogoča vam nastaviti, katere naprave in aplikacije imajo prednost v vašem omrežnem prometu.

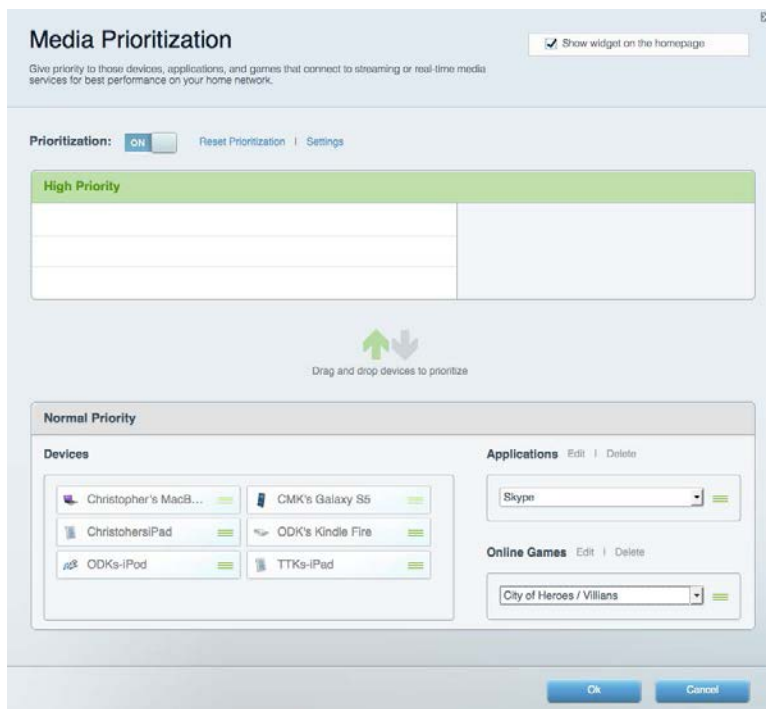

## Preskus hitrosti

Omogoča vam preizkusiti hitrost internetne povezave vašega omrežja.



## Zunanji pomnilnik

Omogoča vam dostop do priključenega USB-pogona (ni priložen) in nastavitev souporabe datotek, predstavnostnega strežnika in FTP-dostop.

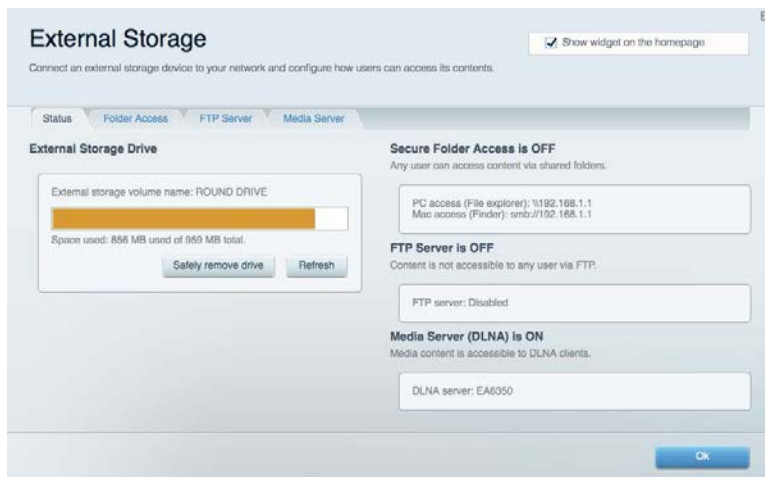

## Povezljivost

Omogoča vam ogled in spremembo osnovnih in naprednih omrežnih nastavitev.

The screenshot shows the 'Connectivity' settings page. It has a title bar with a close button. Below the title is a subtitle 'View and change router settings'. There are several tabs: 'Basic', 'Internet Settings', 'Local Network', 'Advanced Routing', 'VLAN', and 'Administration'. The 'Basic' tab is selected. The page is divided into several sections: 'Network Name and Password' with fields for 2.4 GHz and 5 GHz network names and passwords; 'Router Password' with a masked password field; 'Router Firmware Update' with a checked 'Automatic' checkbox and a 'Check for Updates' button; 'Time Zone' with a dropdown menu set to '(GMT-05:00) Eastern Time (USA & Canada)' and a checked 'Automatically adjust for Daylight Savings Time' checkbox; and 'Activity Lights' with an 'ON' toggle and a text box explaining the power light status. At the bottom, there are 'Ok', 'Cancel', and 'Apply' buttons.

## Odpravljanje napak

Omogoča vam poiskati težave z usmerjevalnikom in preveriti stanje omrežja.

The screenshot shows the 'Troubleshooting' settings page. It has a title bar with a close button. Below the title is a subtitle 'Troubleshoot router settings'. There are three tabs: 'Status', 'Diagnostics', and 'Logs'. The 'Diagnostics' tab is selected. The page is divided into several sections: 'Ping IPv4' with input fields for IP or host name and number of pings, and a 'Start to Ping' button; 'Trace route' with an input field for IP or host name and a 'Start to Traceroute' button; 'Reboot' with a 'Reboot the router' link; 'Router configuration' with 'Backup' and 'Restore' buttons; 'Router Firmware' with a 'Restore previous firmware' button; 'Internet Address' with IPv4 and IPv6 addresses and 'Release and Renew' links; and 'Factory reset' with a 'Reset to factory default settings' link. At the bottom, there is an 'Ok' button.

## Brezžična povezava

Omogoča vam ogled in spremembo brezžičnega omrežja usmerjevalnika. Spremenite lahko imena omrežij, geslo, filtriranje MAC in naprave povežete s funkcijo Wi-Fi Protected Setup.

Wireless

View and change router settings

Wireless MAC Filtering Wi-Fi Protected Setup

Smart Connect:  5 GHz band steering  Off  
5 GHz<sub>1</sub> + 5 GHz<sub>2</sub> Individual networks

What is Smart Connect band steering?

Network name: arachnid 2.4 GHz Network: ON

Password: peterparker Broadcast SSID: Yes Channel: Auto

Security mode: WPA2/WPA Mixed Pt Network mode: Mixed Channel width: Auto

Network name: arachnid\_5GHz 5 GHz<sub>1</sub> + 5 GHz<sub>2</sub> Network: ON

Password: peterparker Broadcast SSID: Yes Channel: Auto

Security mode: WPA2/WPA Mixed Pt Network mode: Auto Channel width: Auto

Ok Cancel Apply

## Varnost

Omogoča vam ogled in spremembo brezžične varnosti usmerjevalnika. Nastavite lahko požarni zid, nastavitve VPN in določite lastne nastavitve za programe in igre.

Security

View and change router settings

Firewall DMZ Apps and Gaming

**Firewall**

IPv4 SPI firewall protection  Enabled

IPv6 SPI firewall protection  Enabled

**Internet filters**

Filter anonymous Internet requests

Filter multicast

Filter Internet NAT redirection

Filter ident (Port 113)

**VPN Passthrough**

IPSec Passthrough  Enabled

PPTP Passthrough  Enabled

L2TP Passthrough  Enabled

**IPv6 Port Services**

Description	Protocol	IPv6 Address	Allow	Enabled
-------------	----------	--------------	-------	---------

Add IPv6 Firewall Setting

Ok Cancel Apply

# Odpravljanje napak

Dodatno pomoč lahko dobite pri naši nagrajeni podpori na naslovu [linksys.com/support/EA8300](http://linksys.com/support/EA8300).

## Usmerjevalnik ni bil uspešno nastavljen

Če Linksys Smart Wi-Fi ni dokončal nastavitve, lahko poskusite z naslednjim:

- S sponko za papir pritisnite in zadržite gumb za ponastavitev na svojem usmerjevalniku, dokler ne zasveti logotip Linksys in modri indikatorji MU-MIMO ne začnejo utripati (približno 10 sekund). Ponovno namestite usmerjevalnik.

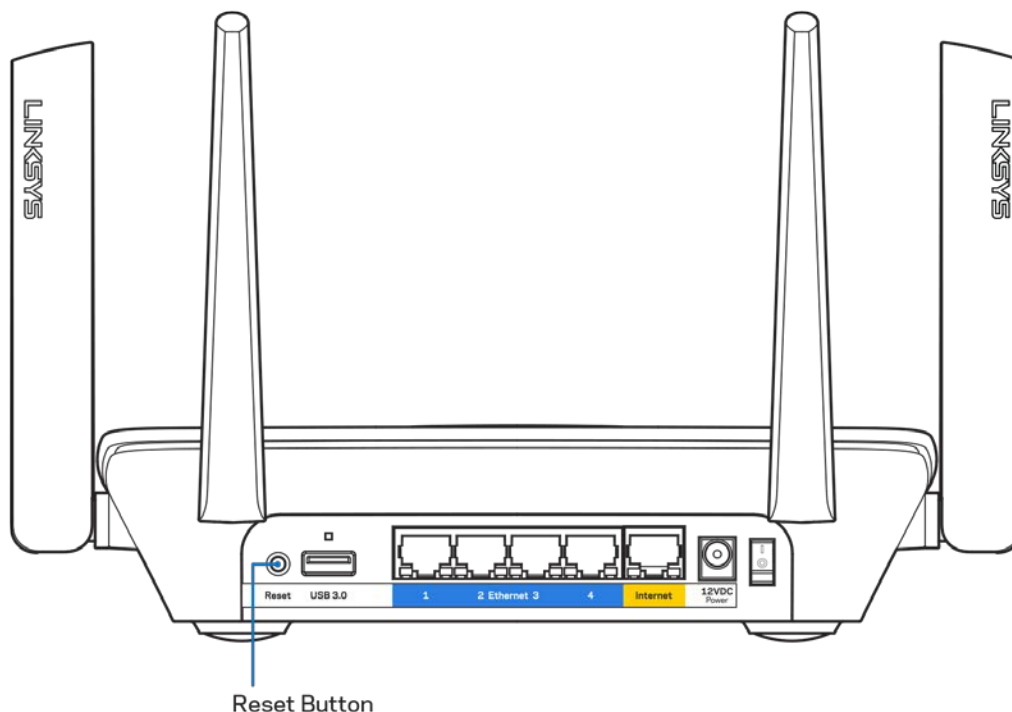

- Začasno onemogočite požarni zid računalnika (za pomoč si oglejte navodila zaščitne programske opreme). Ponovno namestite usmerjevalnik.
- Če imate drug računalnik, na njem še enkrat namestite usmerjevalnik.

## Sporočilo, da internetni kabel ni priklopljen.

Če se pri poskusu nastavitve usmerjevalnika pojavi sporočilo "Your Internet cable is not plugged in (Internetni kabel ni priklopljen)", sledite tem korakom za odpravljanje težav.

- Zagotovite, da je ethernetni ali internetni kabel (ali kabel, priložen usmerjevalniku) varno povezan z rumenimi internetnimi vrati na zadnji strani usmerjevalnika in z ustreznimi vrati na vašem modemu. Ta vrata na modemu so običajno označena kot Ethernet.

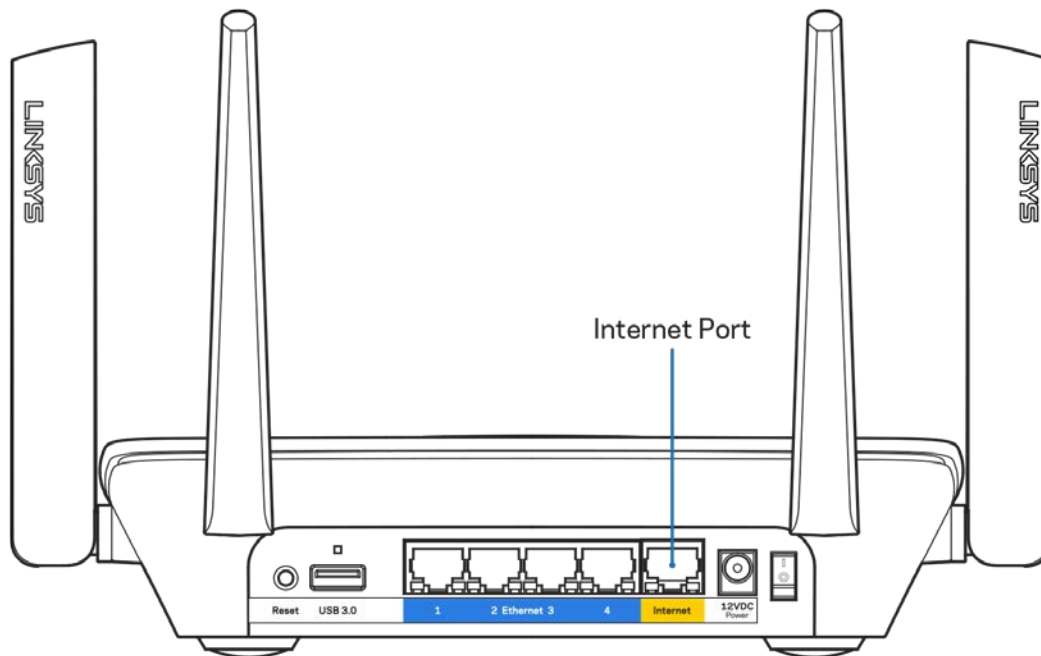

- Preverite, ali je modem priklopljen na napajanje in vklopljen. Če ima stikalo za vklop, preverite, ali je v položaju ON (VKLOP) ali | (v primerjavi z O).

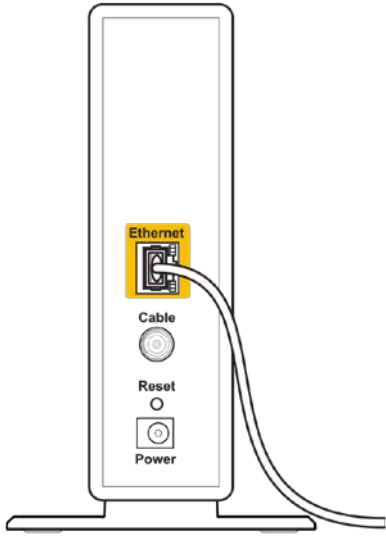
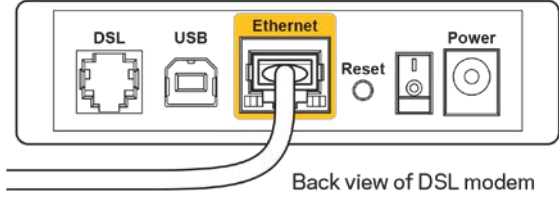
 <p>Back view of cable modem</p>	 <p>Back view of DSL modem</p>
<p>Če imate kabelski internet, preverite, ali so vrata CABLE (KABEL) na kabelskem modemu povezana s koaksialnim kablom, ki ste ga prejeli od ponudnika internetnih storitev.</p>	<p>Če imate DSL, preverite, ali je telefonska linija DSL povezana z vrati DSL na modemu.</p>

- Če je bil računalnik z modemom prej povezan s kablom USB, odklopite kabel USB.
- Ponovno namestite usmerjevalnik.

## ***Sporočilo, da dostop do usmerjevalnika ni mogoč***

Za dostop do usmerjevalnika morate biti povezani v lastno omrežje. Če imate dostop do brezžičnih omrežij, ste se morda pomotoma povezali z drugim brezžičnim omrežjem.

Če želite odpraviti težavo na računalnikih z Windowsi, postopajte kot sledi:

1. Kliknite na ikono za brezžilno omrežje na pladnju sistema. Prikaže se seznam razpoložljivih omrežij.



2. Kliknite ime svojega omrežja. Kliknite Connect (Poveži). V spodnjem primeru je bil računalnik povezan z brezžičnim omrežjem, imenovanim wraith\_5GHz. V tem primeru je kot izbrano ime brezžičnega omrežja Linksys EA8300 prikazano Damaged\_Beez2.4.



3. Če ste pozvani, da vnesete varnostno geslo za omrežje, vnesite svoje geslo (varnostni ključ) v polje security key (Varnostni ključ). Kliknite "OK" (V redu).
4. Računalnik bo vzpostavil povezavo z omrežjem in morali bi imeti dostop do usmerjevalnika.

*\*Glede na različico OS Windows so možne razlike v besedilu ali ikonah v teh korakih.*

Če želite odpraviti težavo na računalnikih Mac, postopajte kot sledi:

1. V menijski vrstici na vrhu zaslona kliknite ikono Wi-Fi. Prikaže se seznam brezžičnih omrežij.
2. V spodnjem primeru je bil računalnik povezan z brezžičnim omrežjem, imenovanim wraith\_5GHz. V tem primeru je kot izbrano ime brezžičnega omrežja Linksys EA8300 prikazano Damaged\_Beez2.4.

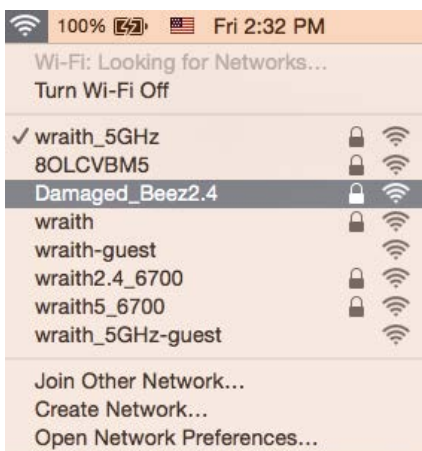

3. Kliknite na ime brezžičnega omrežja vašega usmerjevalnika Linksys EA8300 (Damaged\_Beez2.4 v tem primeru).
4. V polje *Password* (Geslo) vnesite geslo svojega brezžičnega omrežja (varnostni ključ). Kliknite "OK" (V redu).

## Po nastavitvi

### Videti je, da internet ni na voljo

Če ima internet težave komunicirai z vašim usmerjevalnikom, se lahko težava prikaže kot sporočilo "Cannot find [Internet address]" (Ni mogoče najti (spletni naslov)) v vašem spletnem brskalniku. Če veste, da je spletni naslov pravilen in ste poskusili z več veljavnimi spletnimi naslovi in vedno prejeli enak rezultat, lahko sporočilo pomeni, da je težava pri vašem ponudniku storitev ali modemu, ki komunicira z vašim usmerjevalnikom. Poskusite tole:

- Preverite, ali so omrežni in električni kabli dobro priključeni.
- Zagotovite, da je v električni vtičnici, v katero je priključen vaš računalnik, električni tok.
- Znova zaženite usmerjevalnik.
- Stopite v stik s svojim ponudnikom storitev in ga vprašajte o morebitnem izpadu omrežja na vašem območju.

Najpogostejši način odpravljanja težav z usmerjevalnikom je, da ga izključite in spet vključite. Vaš usmerjevalnik lahko nato ponovno naloži svoje nastavitve po meri, druge naprave (kot je modem) pa bodo lahko ponovno zaznale usmerjevalnik in komunicirale z njim. Ta postopek se imenuje ponovni zagon.

Za ponovni zagon usmerjevalnika z električnim kablom postopajte kot sledi:

1. Odklopite električni kabel iz usmerjevalnika in modema.
2. Počakajte 10 sekund in nato električni kabel znova priklopite v modem. Prepričajte se, da je prisoten električni tok.
3. Počakajte, da indikator za spletno povezavo na modemu preneha utripati (pribl. dve minuti). Ponovno priklopite električni kabel v usmerjevalnik.
4. Počakajte, da osvetljeni logotip Linksys zasveti. Počakajte dve minuti, preden se poskusite povezati s spletom z računalnika.

Za ponovni zagon usmerjevalnika s funkcijo Linksys Smart Wi-Fi postopajte kot sledi:

1. Prijavite se v Linksys Smart Wi-Fi. (Glejte "Povezovanje z Linksys Smart Wi-Fi" na strani [11](#).)
2. Pod *Router Settings* (Nastavitve usmerjevalnika) kliknite *Troubleshooting* (Odpravljanje težav).
3. Kliknite zavihek *Diagnostics* (Diagnostika).
4. Pod *Reboot* (Ponovni zagon) kliknite *Reboot* (Ponovni zagon).



5. Kliknite **Yes (Da)**. Usmerjevalnik se bo ponovno zagnal. Medtem, ko se usmerjevalnik znova zaganja, bodo vse povezane naprave izgubile internetno povezavo in se bodo ponovno povezale, ko bo usmerjevalnik znova pripravljen.

## Linksys Smart Wi-Fi se ne odpre v vašem spletnem brskalniku

Z Linksys Smart Wi-Fi delujejo najnovejše različice brskalnikov Google Chrome™, Firefox®, Safari® (za Mac® in iPad®), Microsoft Edge in Internet Explorer® različica 8 in novejša.

# Specifikacije

## Linksys EA8300

Ime modela	Max-Stream AC2200 MU-MIMO tripasovni usmerjevalnik
Številka modela	EA8300
Sprememba hitrosti vrat	10/100/1000 Mb/s (gigabitni ethernet)
Radijska frekvenca	2,4 GHz in 5 GHz (x2)
Št. anten	4 zunanjih nastavljivih anten (neodstranljive)
Vrata	USB 3.0, Ethernet (1-4), internet, napajanje
Gumbi	Wi-Fi Protected Setup, napajanje, ponastavitev
LED-lučke	<b>Zgornja plošča:</b> Osvetljen logotip Linksys , Wi-Fi Protected Setup, internetna povezava, povezava omrežnega kabla z internetnimi vrati <b>Zadnja stran:</b> USB, Ethernet (1-4), internet
UPnP	Podprt
Varnostne funkcije	WEP, WPA2, RADIUS
Vrsta varnostnega ključa	Do 128-bitno šifriranje
Podpora datotečnega sistema za shranjevanje	FAT, NTFS in HFS+
Podprti brskalniki	Najnovejše različice brskalnikov Google Chrome™, Firefox®, Safari® (za Mac® in iPad®), Microsoft Edge in Internet Explorer® različica 8 in novejša.

## Okoljski podatki

Dimenzije	213,7mm x 161,8mm x 54,8mm (brez anten)
Teža enote	608 g
Napajanje	12 V, 2A
Certifikati	FCC, IC, CE, Wi-Fi (a/b/g/n/ac)
Obratovalna temperatura	32 do 104 °F (0 do 40 °C)
Temperatura skladiščenja	-4 do 140 °F (20 do 60 °C)
Vlažnost za delovanje	10 do 80 % relativne vlažnosti, brez kondenzacije
Vlažnost za shranjevanje	5% do 90% brez kondenzata

Tehnični podatki se lahko spremenijo brez predhodnega obvestila.

Opombe:

Informacije o zakonskih predpisih, jamstvu in varnosti si oglejte na CD-ju, ki je priložen brskalniku ali obiščite [Linksys.com/support/EA8300](http://Linksys.com/support/EA8300).

Najvišja učinkovitost delovanja je izpeljana iz specifikacij standarda IEEE 802.11. Dejanska učinkovitost se lahko od te razlikuje, vključno z nižjo zmogljivostjo brezžičnega omrežja, hitrostjo pretoka, dosegom in pokritostjo. Delovanje je odvisno od številnih dejavnikov, pogojev in spremenljivk, vključno z oddaljenostjo od dostopne točke, količino omrežnega prometa, materiali zgradbe in vrsto gradnje, uporabljenim operacijskim sistemom, različnimi uporabljenimi brezžičnimi izdelki, motenj in drugih neželenih vplivov.

BELKIN, LINKSYS in številna imena izdelkov in logotipi so blagovne znamke skupine družb Belkin.

Druge omenjene blagovne znamke so v lasti njihovih lastnikov. Licence in obvestila za programsko opremo neodvisnih izdelovalcev, uporabljeno v tem izdelku, si lahko ogledate tukaj:

<http://support.linksys.com/en-us/license>. Za vprašanja ali zahtevo za izvorno kodo GPL se obrnite na <http://support.linksys.com/en-us/gplcodecenter>.

© 2017 Belkin International, Inc. in/ali njegove hčerinske družbe. Vse pravice pridržane.

**LINKSYS®**

Användarhandbok

**MAX-STREAM™  
AC2200 MU-MIMO  
TREBANDSROUTER**

Modell EA8300

# Innehåll

Produktöversikt.....	3
Ovansida.....	3
Indikator för systemstatus.....	4
Baksida.....	5
Sidovy.....	6
Installation: grunderna.....	7
Här hittar du mer hjälp.....	7
Installera routern.....	8
Använda Linksys Smart Wi-Fi.....	11
Ansluta till Linksys Smart Wi-Fi.....	11
Nätverkskarta.....	12
Gäståtkomst.....	12
Föräldrakontroll.....	13
Medieprioritering.....	13
Hastighetstest.....	14
Extern lagring.....	14
Anslutning.....	15
Felsökning.....	15
Trådlöst.....	16
Säkerhet.....	16
Felsökning.....	17
Installationen av routern misslyckades.....	17
<i>Internetkabeln är inte ansluten</i> -meddelande.....	18
<i>Kunde inte nå routern</i> -meddelande.....	19
Efter installationen.....	21
Det går inte att ansluta till internet.....	21
Linksys Smart Wi-Fi öppnas inte i webbläsaren.....	22
Specifikationer.....	23
Linksys EA8300.....	23
Omgivande miljö.....	23

# Produktöversikt

## Ovansida

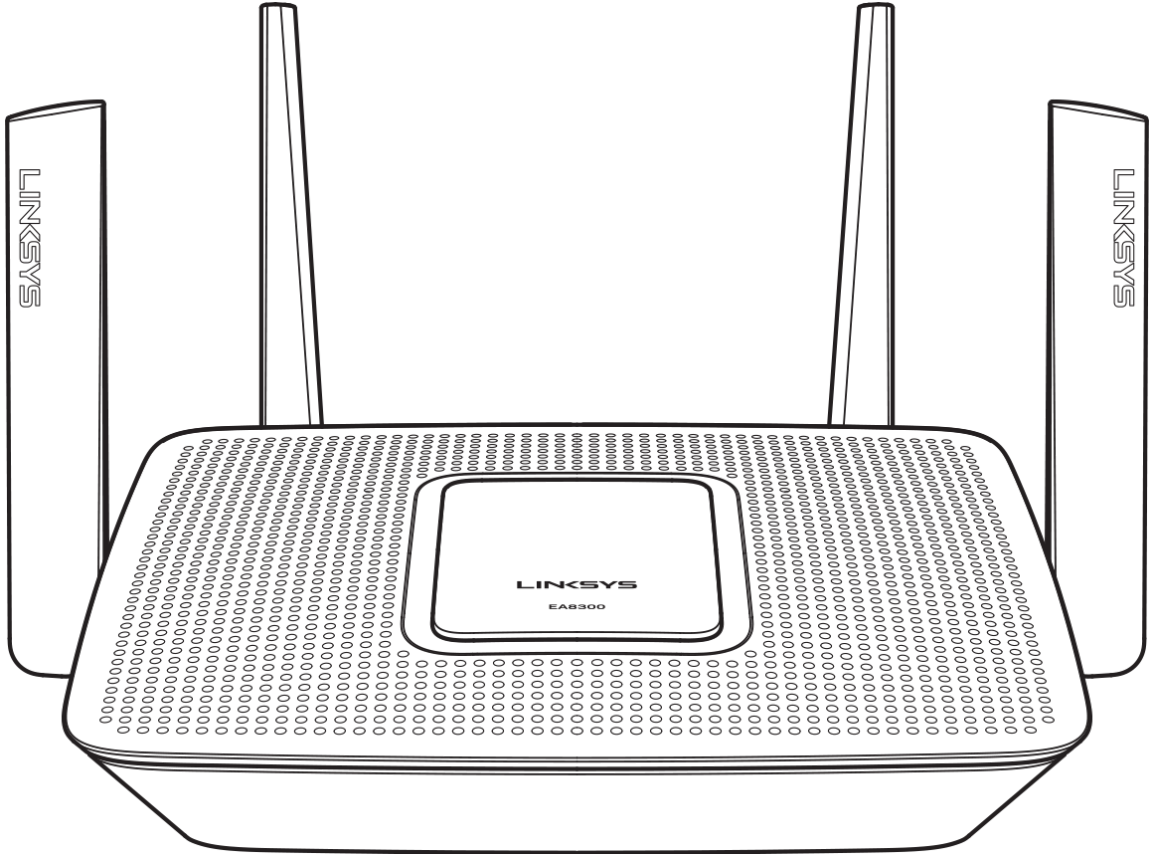



## Indikator för systemstatus

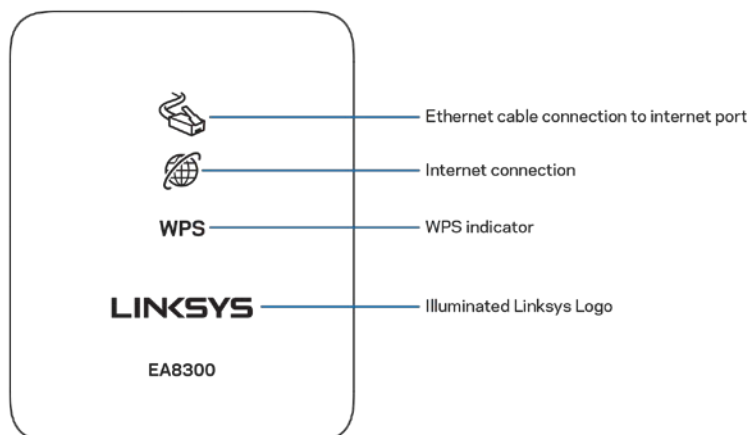

**Nätverkskabelanslutning till internetport**—När den är tänd (orange), indikerar den att det finns ett problem med nätverkskabeln som är ansluten till internetporten (WAN).

**Internetanslutning**—När den är tänd (orange), indikerar den att routern inte har åtkomst till internet.

**Indikator för WPS (Wi-Fi Protected Setup™)**—WPS-lampan har fyra lägen:

<b>Släckt</b>	Ingen Wi-Fi Protected Setup-aktivitet
<b>Blinkar vitt</b>	Wi-Fi Protected Setup pågår
<b>Fast vitt</b>	Wi-Fi Protected Setup är slutförd; fortsätter att vara tänd i fem sekunder
<b>Blinkar orange</b>	Wi-Fi Protected Setup-fel; blinkar i en minut och slocknar sedan

**Belyst Linksys-logotyp**—Blinkar medan routern startar. När logotypen lyset fast vit, har routern ström och fungerar korrekt.

## Baksida

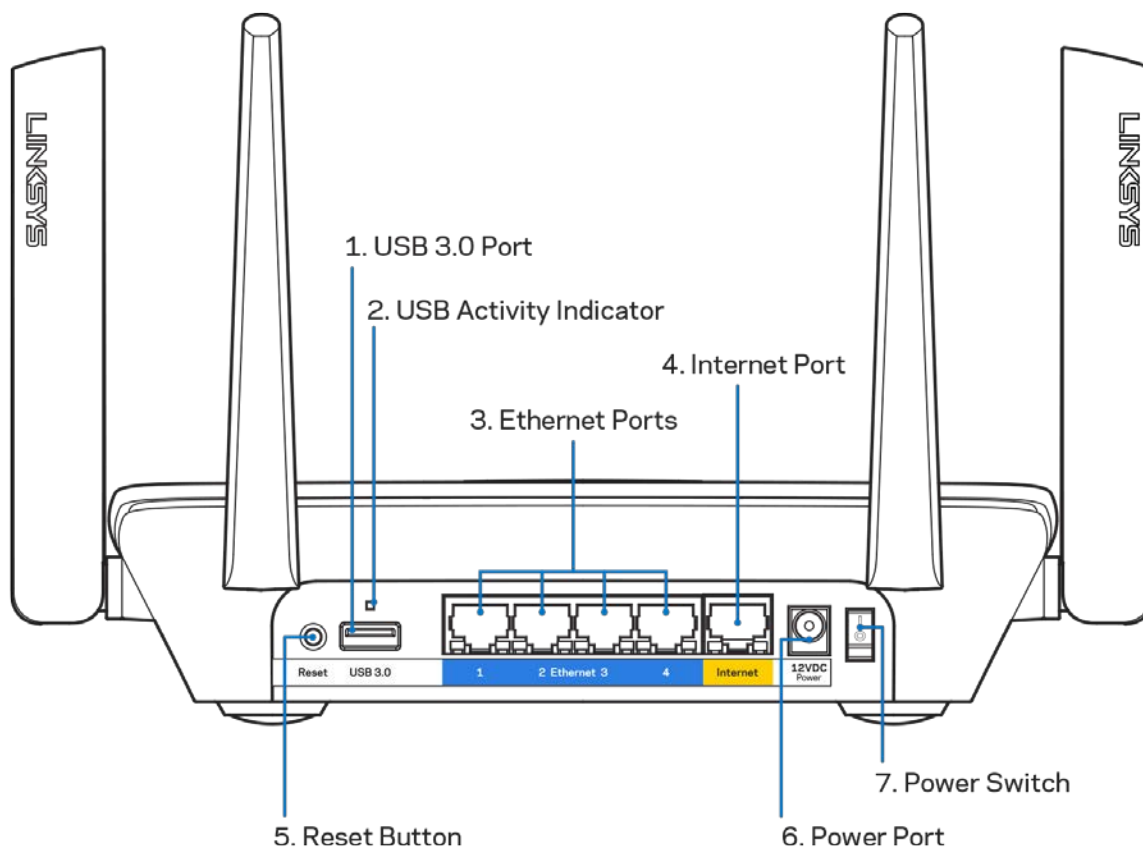

**USB 3.0-port (1)** - Anslut och dela USB-enheter i nätverket eller på internet.

**Lampa för USB-aktivitet (2)**—Tänds vid dataöverföring till/från externa enheter.

**Ethernetportar(3)** - Anslut Ethernetkablar till dessa Gigabit Ethernet (10/100/1000)-portar och till andra kabelbundna enheter i nätverket.

*Obs! - För bästa prestanda bör du ansluta kablar av typen CAT5E eller bättre till Ethernetportarna.*

**Internetport (4)**—Anslut en Ethernetkabel mellan den gula gigabitporten (10/100/1000) och ett modem för bredbandsanslutning till internet via kabel/DSL eller fiber.

*OBS!—För bästa prestanda bör du ansluta kablar av typen CAT5E eller bättre till internetporten*

**Återställningsknapp (5)**—Tryck på och håll knappen intryckt tills dess att den belysta Linksys-logotypen släcks för att återställa routern till fabriksinställningen. Du kan också återställa fabriksinställningarna med Linksys Smart Wi-Fi via internet eller mobilappen.

**Strömport (6)**—Anslut strömadaptern som följer med.

**Strömknapp (7)**—Tryck på| (på) för att slå på routern.

## Sidovy

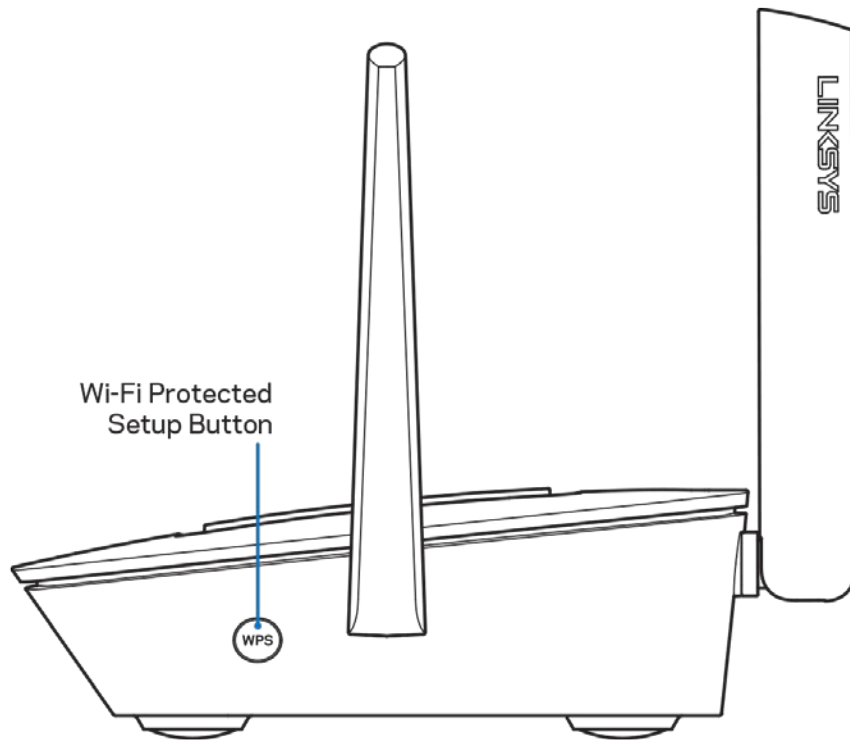

**Wi-Fi Protected Setup™-knapp**—Tryck på knappen för att ansluta till WPS-aktiverade nätverksenheter.

# Installation: grunderna

## Här hittar du mer hjälp

Utöver den här användarhandboken kan du hitta hjälp på följande ställen:

- [Linksys.com/support/EA8300](http://Linksys.com/support/EA8300) (dokumentation, hämtningar, vanliga frågor, teknisk support, chatt, forum)
- Linksys Smart Wi-Fi-hjälp (anslut till Linksys Smart Wi-Fi och klicka på Help (Hjälp) överst på skärmen)

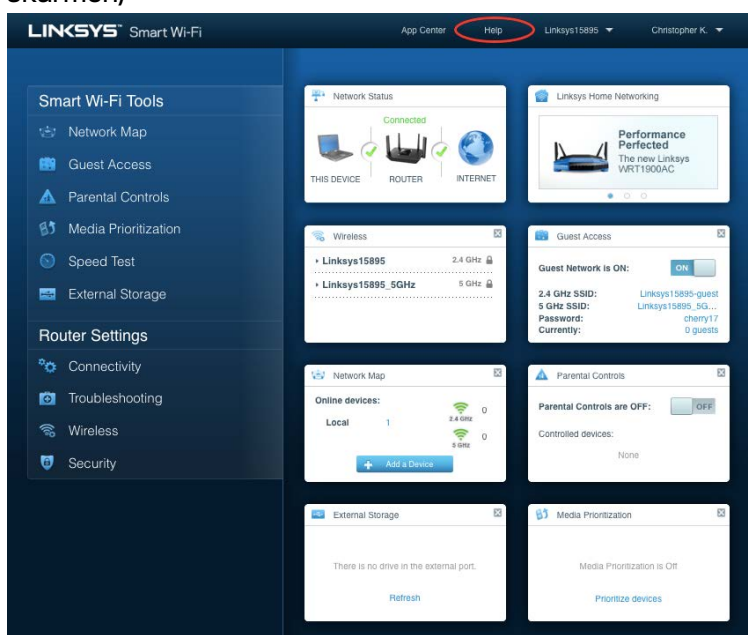

The screenshot shows the Linksys Smart Wi-Fi web interface. The top navigation bar includes 'App Center', 'Help' (highlighted with a red circle), 'Linksys15895', and 'Christopher K.'. The main content area is divided into several sections: 'Smart Wi-Fi Tools' (Network Map, Guest Access, Parental Controls, Media Prioritization, Speed Test, External Storage), 'Router Settings' (Connectivity, Troubleshooting, Wireless, Security), 'Network Status' (Connected), 'Linksys Home Networking' (Performance Perfected), 'Wireless' (Linksys15895, Linksys15895\_5GHz), 'Guest Access' (Guest Network is ON), 'Network Map' (Online devices), 'Parental Controls' (Parental Controls are OFF), 'External Storage' (No drive in the external port), and 'Media Prioritization' (Media Prioritization is Off).

### Help

#### Using Linksys Smart Wi-Fi

Linksys Smart Wi-Fi allows you to access all of your router's features and settings. Simply click on a feature or widget you want to open.

You can use Linksys Smart Wi-Fi to:

- See what's currently connected to your network, and connect more computers and devices.
- Create a Linksys Smart Wi-Fi account to access router settings from anywhere using any browser, even when you're away from home. You can personalize your router and change settings for wireless access, Internet, gaming, local network, and more. You can even access router settings for multiple routers, which is helpful if you set up and manage more than one router. (The account is available only on EA-Series routers.)
- Allow guests in your home to use the Internet without giving them access to your network. While on the guest network, users can surf the net, but won't be able to access your printers, other computers, or devices on your network.

#### Help Categories

- Linksys Smart Wi-Fi
- Device List
- Guest Access
- Parental Controls
- Media Prioritization
- Speed Test
- External Storage
- Connectivity

Ok

**Obs!**—Licenser och anmärkningar gällande programvara från tredje part som används i denna produkt kan granskas på <http://support.linksys.com/en-us/license> Kontakta <http://support.linksys.com/en-eu/gplcodecenter> om du har frågor eller vill få tillgång till GPL-källkoden.

## Installera routern

1. För att slutföra inställningen behöver du en dator för att besöka <http://LinksysSmartWiFi.com> i en webbläsare.
2. Identifiera din utrustning.

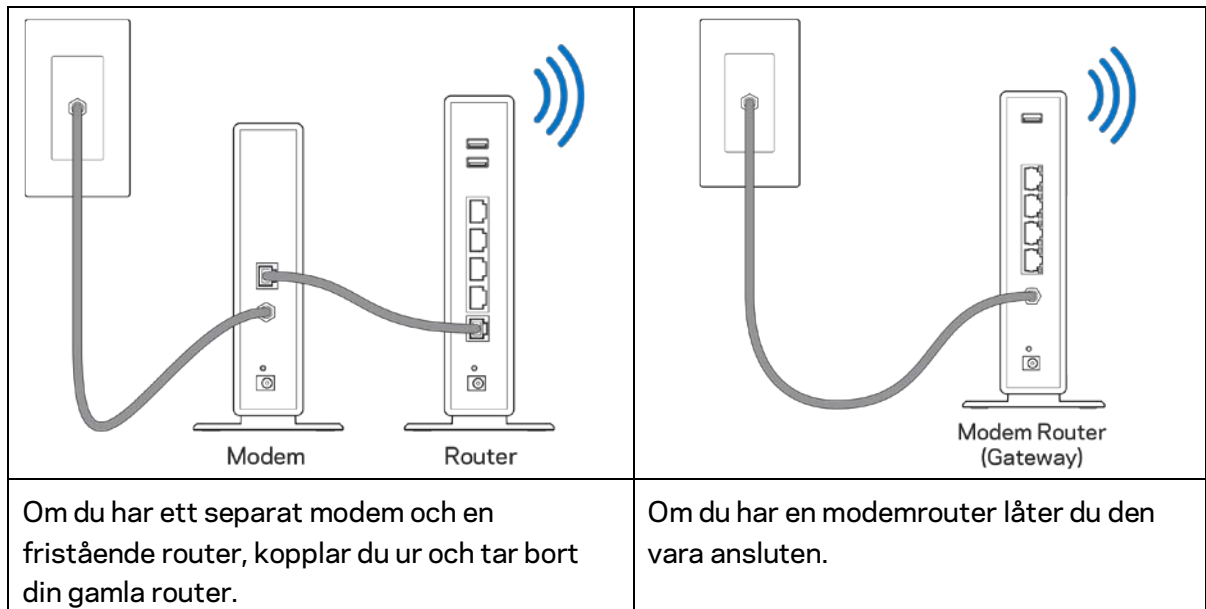

3. Ställ antennerna rakt upp på det sätt som visas och anslut routern till en strömkälla. Se till att strömbrytare är i | läge on.
4. Anslut din router till ditt modem eller modemrouter. Anslut den ena änden av den medlevererade internetkabeln till den gula internetporten på din nya router. Om du har ett modem, ansluter du den andra änden till Ethernet (LAN)-porten på modemmet. Om du har en modemrouter ansluter du den till någon tillgänglig port.
5. Vänta tills dess att Linksys-lampan på överdelen av din router slutar blinka och lyser fast vit.
6. Anslut till det trådlösa nätverksnamn som visas i den Snabbstartguide som följde med routern. (Du kan ändra de här uppgifterna senare.) Om du behöver hjälp med att ansluta till ditt nätverk hänvisar vi till dokumentationen för enheten på [linksys.com/support/EA8300](http://linksys.com/support/EA8300).

**Obs!** Du kan inte ansluta till internet förrän routerinstallationen är klar.

7. Ange <http://LinksysSmartWiFi.com> i en webbläsare. Slutför installationen av routern genom att följa anvisningarna på skärmen. Du kan även ange 192.168.1.1 i en webbläsare för att starta installationen.

I slutet av installationen följer du anvisningarna på skärmen för att skapa ett Linksys Smart Wi-Fi-konto. Använd Linksys Smart Wi-Fi för att ställa in din router från valfri dator som har en internetanslutning.

Hantera routerinställningar:

- Ändra routerns namn och lösenord
- Ställa in gäståtkomst
- Konfigurera föräldrakontroll
- Ansluta enheterna till ditt Wi-Fi
- Testa hastigheten på internetanslutningen

**Obs!**-När du skapar ditt Linksys Smart Wi-Fi-konto får du en bekräftelse via e-post. Klicka på länken i mejlet medan du är ansluten till ditt hemnätverk så associeras routern till Linksys Smart Wi-Fi-kontot.

**Tips**-Skriv ut den här sidan och skriv ned dina router- och kontoinställningar i tabellen nedan Förvara uppgifterna på ett säkert ställe.

2.4 GHz Wi-Fi-namn	
Wi-Fi-lösenord	
5 GHz <sub>1</sub> Wi-Fi-namn	
Wi-Fi-lösenord	
5 GHz <sub>2</sub> Wi-Fi-namn	
Wi-Fi-lösenord	
Routerlösenord	
2,4 GHz Gäst-Wi-Fi-namn	
5 GHz Gäst Wi-Fi-namn	
Lösenord för gästnätverk (båda gästnätverken delar på ett lösenord.)	
Användarnamn för Linksys Smart Wi-Fi	
Lösenord för Linksys Smart Wi-Fi	

# Använda Linksys Smart Wi-Fi

Routern kan administreras var du än befinner dig via Linksys Smart Wi-Fi, men du kan också konfigurera routern direkt från ditt hemnätverk. Eventuellt finns Linksys Smart Wi-Fi även för din mobila enhet. Se efter i enhetens appbutik.

## Ansluta till Linksys Smart Wi-Fi

Så här ansluter du till Linksys Smart Wi-Fi:

1. Starta datorns webbläsare.
2. Gå till <http://LinksysSmartWiFi.com> och logga in på ditt konto.

Linksys Smart Wi-Fi Sign In

If you have not yet created a Linksys Smart Wi-Fi account, click the "Create Account" button in the upper right corner of the page.

Give guests Internet access

Use your Linksys Smart Wi-Fi account to access your home network from anywhere, at any time, even from your mobile device. Easily connect new devices, set parental controls, get access to Smart Wi-Fi mobile Apps, and more.

For more information [click here](#)

English (United States)

For local access, [click here](#).

Om du har glömt ditt lösenord klickar du på *Forgot your password?* (Har du glömt ditt lösenord?) och följer anvisningarna på skärmen.



## Nätverkskarta

Med listan kan du visa och hantera alla nätverksenheter som är anslutna till din router. Du kan visa enheter i huvud- och gästnätverket eller visa information om varje enhet.



## Gäståtkomst

Låter dig konfigurera och övervaka ett nätverk för gäster så att de kan komma åt ett trådlöst nätverk utan att du avslöjar personlig information.

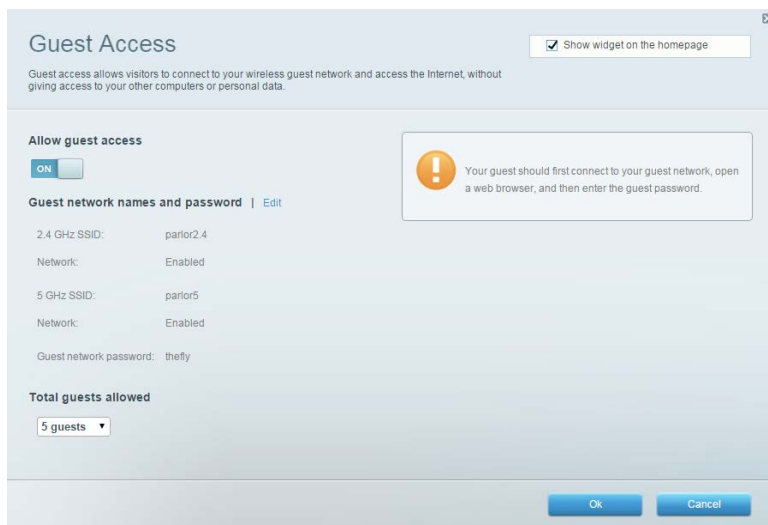

## Föräldrakontroll

Gör det möjligt att blockera webbplatser och ställa in tider för internetåtkomst.

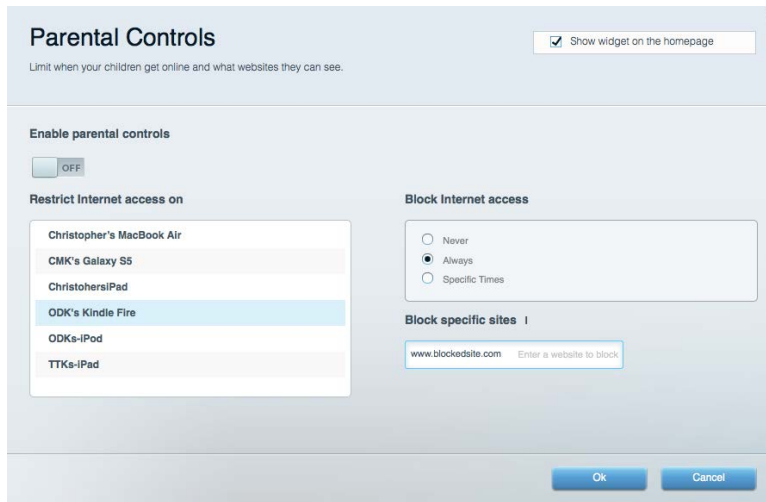

## Medieprioritering

Gör det möjligt att ställa in vilka enheter och program som får högsta prioritet i nätverkstrafiken.

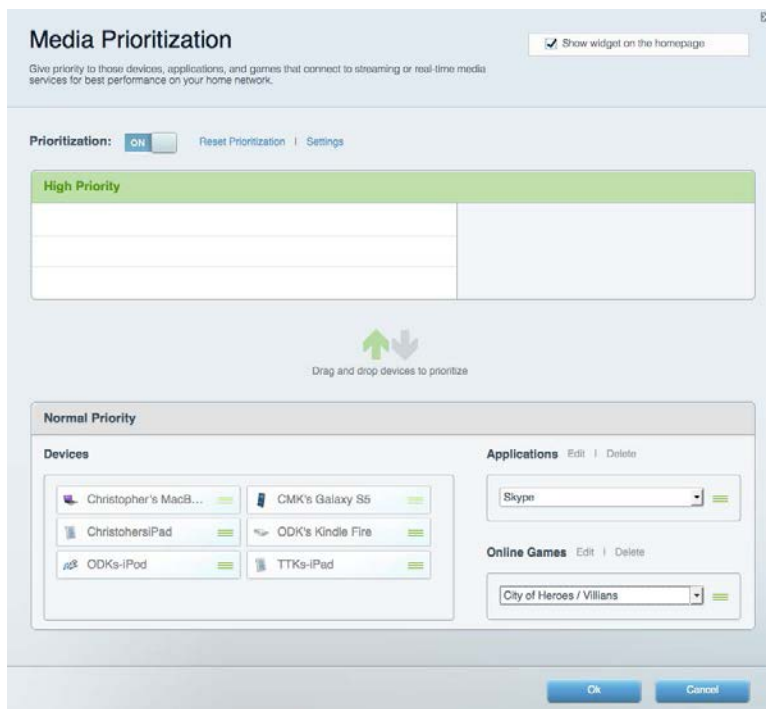

## Hastighetstest

Gör det möjligt att testa internetanslutningens hastighet.



## Extern lagring

Gör det möjligt att komma åt en ansluten USB-enhet (ingår ej) och att ställa in fildelning, en mediaserver och FTP-anslutning.

The 'External Storage' configuration window includes the following sections:

- External Storage Drive:** Volume name: ROUND DRIVE. Space used: 886 MB used of 960 MB total. Buttons: Safely remove drive, Refresh.
- Folder Access:** Secure Folder Access is OFF. Any user can access content via shared folders. PC access (File explorer): \\192.168.1.1; Mac access (Finder): smb://192.168.1.1.
- FTP Server:** FTP Server is OFF. Content is not accessible to any user via FTP. FTP server: Disabled.
- Media Server (DLNA):** Media Server (DLNA) is ON. Media content is accessible to DLNA clients. DLNA server: EA6050.

There is a checkbox 'Show widget on the homepage' and an 'Ok' button at the bottom right.

# Anslutning

Gör det möjligt att konfigurera grundläggande och avancerade nätverksinställningar.

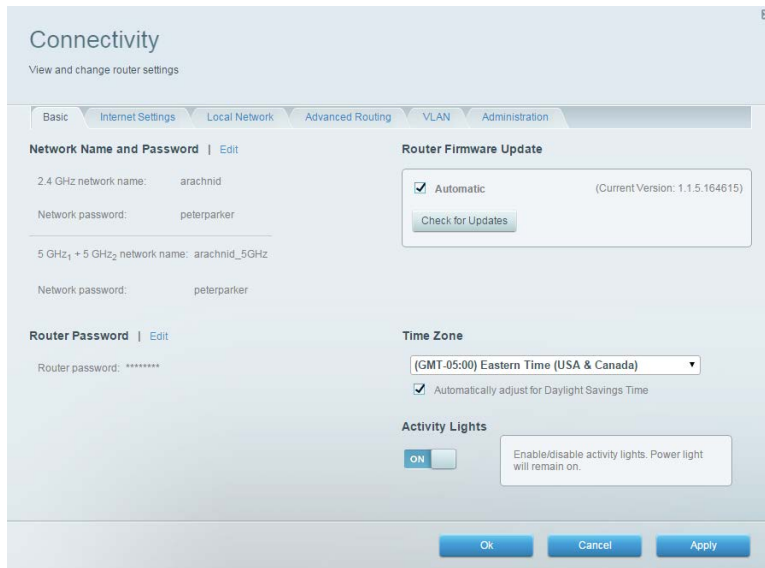

# Felsökning

Gör det möjligt att diagnosticera problem med routern och kontrollera nätverkets status.

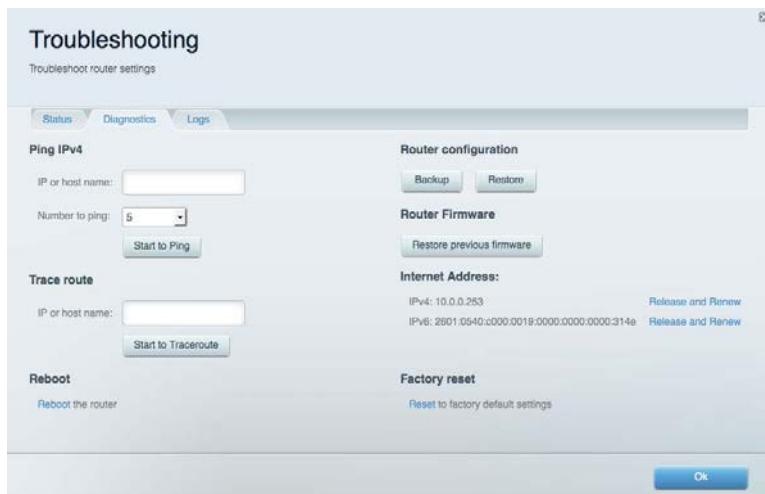

## Trådlöst

Låter dig visa och ändra din routers trådlösa nätverk. Du kan ändra nätverksnamn, säkerhetsläge, lösenord, MAC-filtrering och ansluta enheter med hjälp av Wi-Fi Protected Setup™.

The screenshot shows the 'Wireless' settings page. At the top, there is a 'Show widget on the homepage' checkbox which is checked. Below this, there are tabs for 'Wireless', 'MAC Filtering', and 'Wi-Fi Protected Setup'. The 'Smart Connect' section has two radio buttons: '5 GHz band steering' (selected) and 'Off'. Below this, there are two network configuration sections. The first is for the 2.4 GHz network, with 'Network name' set to 'arachnid', 'Password' to 'peterparker', 'Broadcast SSID' to 'Yes', 'Channel' to 'Auto', and 'Security mode' to 'WPA2/WPA Mixed Pk'. The second section is for the 5 GHz network, with 'Network name' set to 'arachnid\_5GHz', 'Password' to 'peterparker', 'Broadcast SSID' to 'Yes', and 'Security mode' to 'WPA2/WPA Mixed Pk'. At the bottom, there are 'Ok', 'Cancel', and 'Apply' buttons.

## Säkerhet

Låter dig visa och ändra din routers trådlösa säkerhet. Du kan konfigurera brandvägg, VPN-inställningar och göra anpassade inställningar för program och spel.

The screenshot shows the 'Security' settings page. At the top, there is a 'View and change router settings' link. Below this, there are tabs for 'Firewall', 'DMZ', and 'Apps and Gaming'. The 'Firewall' section has two checkboxes: 'IPv4 SPI firewall protection' and 'IPv6 SPI firewall protection', both of which are checked and labeled 'Enabled'. The 'VPN Passthrough' section has three checkboxes: 'IPSec Passthrough', 'PPTP Passthrough', and 'L2TP Passthrough', all of which are checked and labeled 'Enabled'. The 'Internet filters' section has four checkboxes: 'Filter anonymous Internet requests' (checked), 'Filter multicast' (unchecked), 'Filter Internet NAT redirection' (unchecked), and 'Filter ident (Port 113)' (checked). At the bottom, there is a table for 'IPv6 Port Services' with columns for 'Description', 'Protocol', 'IPv6 Address', 'Allow', and 'Enabled'. Below the table is an 'Add IPv6 Firewall Setting' button. At the bottom of the page, there are 'Ok', 'Cancel', and 'Apply' buttons.

# Felsökning

Om du vill ha mer hjälp kan du när du vill under dygnet gå till vår prisbelönta support på [linksys.com/support/EA8300](https://linksys.com/support/EA8300).

## Installationen av routern misslyckades

Om Linksys Smart Wi-Fi inte slutförde installationen provar du följande:

- Tryck in och håll inne återställningsknappen på din router med ett gem eller en nål tills dess att Linksys-logotypen slocknar och de blåa MU-MIMO indikatorerna börjar blinka (ungefär 10 sekunder). Installera routern igen.

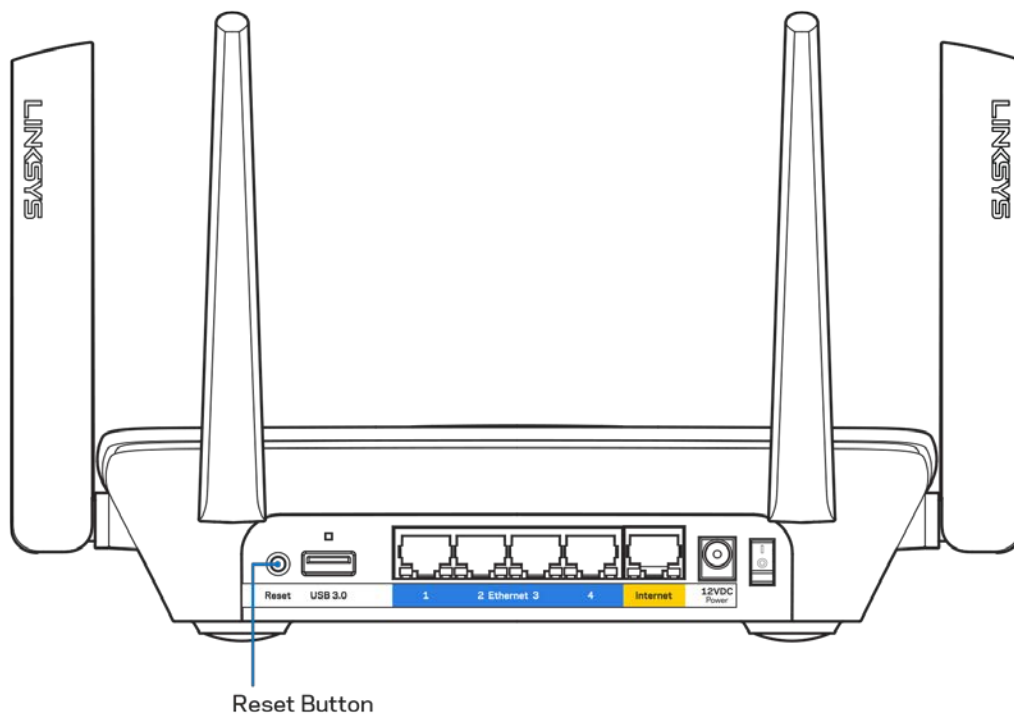

- Avaktivera datorns brandvägg tillfälligt (läs anvisningarna för säkerhetsprogramvaran). Installera routern igen.
- Om du har en annan dator provar du att installera routern på nytt från den datorn.

## Internetkabeln är inte ansluten-meddelande

Om du får meddelandet "Internetkabeln är inte ansluten" när du försöker installera routern följer du de här felsökningsstegen.

- Kontrollera att en Ethernet-kabel (eller en kabel som den som följde med routern) är ordentligt ansluten till den gula internetporten på baksidan av routern och till lämplig port på modemmet. Den här porten på modemmet brukar vara märkt Ethernet.

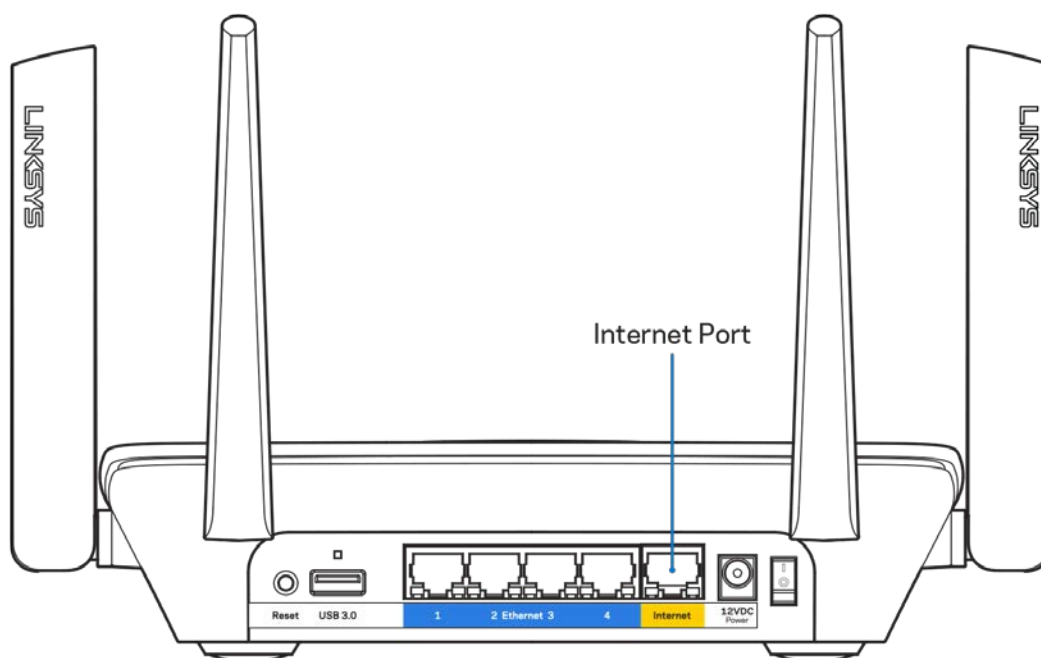

- Se till att modemmet är anslutet till ett eluttag och är påslaget. Om det har en strömbrytare kontrollerar du att den står i läge ON eller I (i motsats till O).

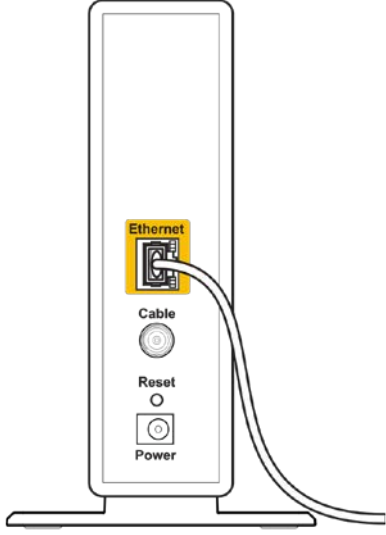
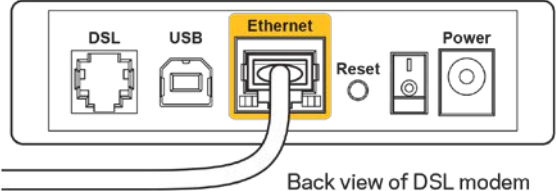
 <p>Back view of cable modem</p>	 <p>Back view of DSL modem</p>
<p>Om du har kabelanslutning till internet kontrollerar du att kabelmodemets CABLE-port är ansluten till den koaxialkabel som du fått från internetleverantören.</p>	<p>Om du har internetanslutning via DSL kontrollerar du att DSL-telefonlinjen är ansluten till modemets DSL-port.</p>

- Om datorn var ansluten till modemmet med en USB-kabel tidigare kopplar du från USB-kabeln.
- Installera routern igen.

## ***Kunde inte nå routern-meddelande***

För att komma åt routern måste du vara ansluten till ditt eget nätverk. Om du har internetåtkomst via ett trådlöst nätverk kan problemet vara att du av misstag har anslutit till ett annat trådlöst nätverk.

Så här löser du problemet på Windows-datorer:

1. Klicka på ikonen för det trådlösa nätverket i aktivitetsfältet. En lista över tillgängliga nätverk visas.



2. Klicka på ditt eget nätverksnamn. Klicka på Anslut. I exemplet nedan var datorn ansluten till ett annat nätverk som hette wraith\_5GHz. Namnet på Linksys EA8300-routers trådlösa nätverk, Damaged\_Beez2.4 i exemplet, visas markerat.



3. Om du blir ombedd att ange en säkerhetsnyckel för nätverket, skriver du in lösenordet (säkerhetsnyckel) i fältet för nätverkets säkerhetsnyckel. Klicka på **OK**.
4. Din dator kommer att ansluta till nätverket och du bör kunna ansluta till routern.

*\*Beroende på Windows-version kan de exakta formuleringarna och ikonerna i de här stegen variera något.*

Så här löser du problemet på Mac-datorer:

1. Klicka på Wi-Fi-symbolen i menyfältet högst upp på skärmen. En lista över trådlösa nätverk visas.
2. I exemplet nedan var datorn ansluten till ett annat nätverk som hette wraith\_5GHz. Namnet på Linksys EA8300-routers trådlösa nätverk, Damaged\_Beez2.4 i exemplet, visas markerat.



3. Klicka på Linksys EA8300-routerns trådlösa nätverk (Damaged\_Beez2.4 i exemplet).
4. Ange det trådlösa nätverkets lösenord (säkerhetsnyckel) i *fältet för lösenord*. Klicka på **OK**.

## Efter installationen

### Det går inte att ansluta till internet

Om routern verkar ha svårt att kommunicera med internet kan ett meddelande visas i webbläsaren om att webbplatsen inte kan hittas. Om du vet att webbadressen stämmer och du har försökt flera giltiga webbadresser med samma resultat, kan ett problem ha uppstått med internetleverantörens eller modemets kommunikation med routern. Försök med följande:

- Kontrollera att nätverks- och strömkablarna är ordentligt anslutna.
- Kontrollera att det eluttag som routern är ansluten till har ström.
- Starta om routern.
- Kontakta din internetleverantör och fråga om driftavbrott i ditt område.

Den vanligaste felsökningsmetoden är att stänga av routern och sedan sätta på den igen. Då kan de anpassade inställningarna läsas in på nytt, och andra enheter (till exempel modemmet) kan återupptäcka routern och kommunicera med den. Det är så man startar om routern.

Så här startar du om routern med nätkabeln:

1. Dra ut nätkabeln från routern och modemmet.
2. Vänta i tio sekunder och anslut den till modemmet. Kontrollera att den får ström.
3. Vänta tills modemets onlinelampa slutar blinka (ungefär två minuter). Återanslut strömsladden till routern.
4. Vänta tills dess att Linksys-logotypen tänds. Vänta i två minuter och försök sedan ansluta till internet från en dator.

Så här startar du om routern med Linksys Smart Wi-Fi:

1. Logga in på Linksys Smart Wi-Fi. (Se "Ansluta till Linksys Smart Wi-Fi" på sidan [11](#).)
2. Gå till *Router Settings* (Routerinställningar) och klicka på *Troubleshooting* (Felsökning).
3. Klicka på fliken *Diagnostics* (Diagnostik).
4. Klicka på *Reboot* (Starta om) under *Reboot* (Starta om).



5. Klicka på **Yes** (Ja). Routern startas om. Medan routern startas om bryts alla anslutna enheters internetanslutning. Anslutningen återupptas automatiskt när routern är klar att användas igen.

## Linksys Smart Wi-Fi öppnas inte i webbläsaren

De senaste versionerna av Google Chrome™, Firefox®, Safari® (för Mac® och iPad®), Microsoft Edge och Internet Explorer® version 8 och senare fungerar tillsammans med Linksys Smart Wi-Fi.

# Specifikationer

## Linksys EA8300

Modellnamn	Max-Stream AC2200 MU-MIMO trebandsrouter
Modellnummer	EA8300
Switch-porthastighet	10/100/1000 Mbit/s (Gigabit Ethernet)
Radiofrekvens	2.4 GHz och 5 GHz (x2)
Antal antenner	4 externt justerbara antenner (ej demonterbara)
Portar	USB 3.0, Ethernet (1-4), Internet, Ström
Knappar	Wi-Fi Protected Setup, Ström, Återställning
Ljus	<b>Ovansida:</b> Belyst Linksys-logotyp , Wi-Fi Protected Setup, Internetanslutning, Nätverkskabelanslutning till Internetport <b>Baksida:</b> USB, Ethernet (1-4), Internet
UPnP	Kan användas
Säkerhetsfunktioner	WEP, WPA2, RADIUS
Säkerhetsnyckel	Upp till 128-bitars kryptering
Lagringsfilssystem som stöds	FAT, NTFS och HFS+
Webbläsarstöd	De senaste versionerna av Google Chrome™, Firefox®, Safari® (för Mac® och iPad®), Microsoft Edge, och Internet Explorer® version 8 och senare

## Omgivande miljö

Mått	213,7mm x 161,8mm x 54,8mm (utan antenner)
Vikt	608 g
Ström	12 V, 2 A
Certifieringar	FCC, IC, CE, Wi-Fi (a/b/g/n/ac)
Driftstemperatur	0 till 40 °C
Förvaringstemperatur	-20 till 60 °C
Luftfuktighet vid drift	10 % till 80% relativ luftfuktighet, icke-kondenserande
Luftfuktighet vid förvaring	5 till 90 %, icke-kondenserande

Specifikationerna kan ändras utan föregående meddelande.

Obs!

Information om överensstämmelse med regelverk och standarder, samt säkerhet, finns på CD:n som följde med routern och på [Linksys.com/support/EA8300](http://Linksys.com/support/EA8300).

Värdena för maximal överföring kommer från IEEE:s standardspecifikationer för 802.11. Faktiska prestanda kan variera, inklusive lägre kapacitet för trådlöst nätverk, dataöverföringshastighet, räckvidd och täckning. Prestanda påverkas av många faktorer och förutsättningar. Den kan bland annat bero på avståndet till åtkomstpunkten, trafikmängden i nätverket, byggnadsmaterialet och konstruktionen, operativsystemet, vilka trådlösa produkter som används, lokala störningar och andra ogynnsamma villkor.

BELKIN, LINKSYS och många produktnamn och logotyper är varumärken som tillhör Belkin-koncernen. De tredjepartsvarumärken som nämns tillhör deras respektive ägare. Licenser och anmärkningar gällande programvara från tredje part som används i denna produkt finns här: <http://support.linksys.com/en-us/license>. Kontakta <http://support.linksys.com/en-us/gplcodecenter> om du har frågor om, eller vill få tillgång till GPL-källkoden.

© 2017 Belkin International, Inc. och/eller dess närstående bolag. Med ensamrätt.

**LINKSYS®**

使用者指南

MAX-STREAM™  
AC2200 MU-MIMO  
三頻路由器

型號：EA8300

# 目錄

產品概觀 .....	3
頂視圖 .....	3
系統狀態指示燈 .....	4
後視圖 .....	5
側視圖 .....	6
設置：基本知識 .....	7
如何尋找更多說明 .....	7
如何安裝您的路由器 .....	7
如何使用 Linksys Smart Wi-Fi .....	11
如何連線到 Linksys Smart Wi-Fi.....	11
網路地圖 .....	12
來賓存取權限.....	12
家長監控設定.....	13
媒體優先順序.....	13
速度測試.....	14
外部儲存 .....	14
連線能力 .....	15
故障排除 .....	15
無線 .....	16
安全性 .....	16
故障排除 .....	17
您的路由器設定失敗 .....	17
未插入網路纜線訊息 .....	18
無法存取您的路由器訊息.....	19
設定後 .....	21
網際網路似乎無法使用 .....	21
Linksys Smart Wi-Fi 未在您的網路瀏覽器開啟.....	21
規格.....	22
Linksys EA8300 .....	22
環境要求.....	22

# 產品概觀

## 頂視圖

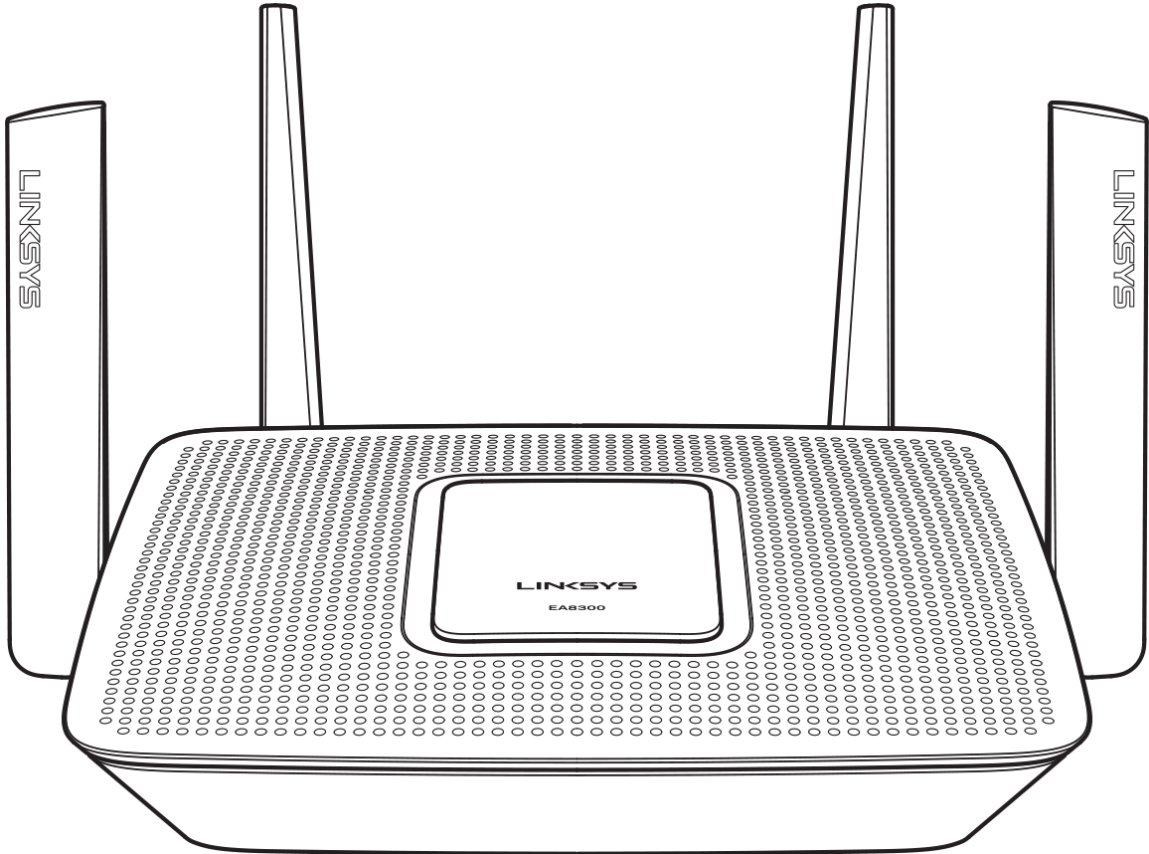



## 系統狀態指示燈

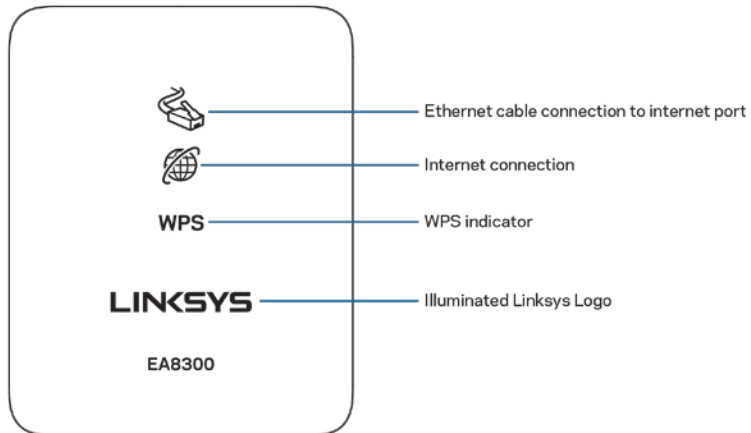

網際網路連接埠的乙太網線連線：如果指示燈亮起（橘色），則表示連接到網際網路（WAN）連接埠的網線出現問題。

網際網路連線：當亮起（橘色）時，表示路由器無法存取網際網路。

WPS (Wi-Fi Protected Setup™) 指示燈：WPS指示燈具有下列四種狀態：

關閉	無「Wi-Fi Protected Setup」活動
閃爍白色	「Wi-Fi Protected Setup」在進行中
常亮白色	Wi-Fi Protected Setup 成功；保持亮起5秒鐘
閃爍橘色	Wi-Fi Protected Setup 錯誤；閃爍一分鐘，接著熄滅

亮起的 Linksys 徽標：當路由器啟動時閃爍。當徽標為常亮白色時，路由器的電源開啟且正確運作。

## 後視圖

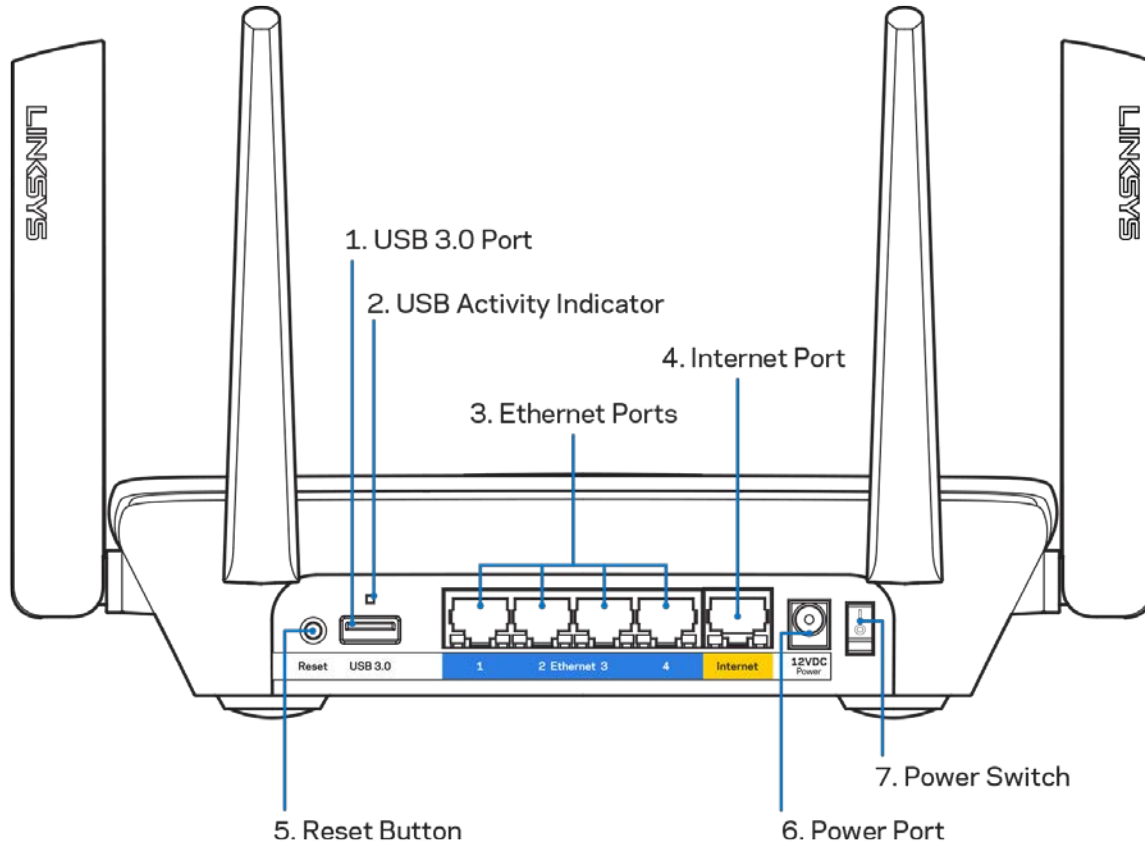

USB 3.0連接埠 (1)：連接USB磁碟機，並在您的網路或網際網路上分享。

USB活動指示燈 (2)：指示燈表示資料與外部設備的傳輸情況。

乙太網路連接埠 (3)：將乙太網路纜線一端連接至此藍色 Gigabit (10/100/1000) 連接埠，並連接至您網路上的有線裝置。

**注意：** 為了獲得最佳效能，請在乙太網連接埠上使用 CAT5e 或更高額定的纜線。

網際網路連接埠 (4)：將乙太網路纜線一端連接至此黃色 Gigabit (10/100/1000) 連接埠，另一端連接至寬頻網際網路纜線/DSL或光纖數據機。

**注意：** 為了獲得最佳性能，請在網際網路連接埠上使用 CAT5E 或更高額定的纜線。

重新開機按鈕 (5)：按住不放此按鈕，直至亮起的 Linksys 徽標熄滅，即可將路由器重設為出廠設定。您也可以使用網際網路上的 Linksys Smart Wi-Fi 或行動應用程式來還原為出廠設定。

電源埠 (6)：用於連接隨附的交流電電源適配器。

電源開關 (7)：按下 I (開啟) 來打開路由器。

## 側視圖

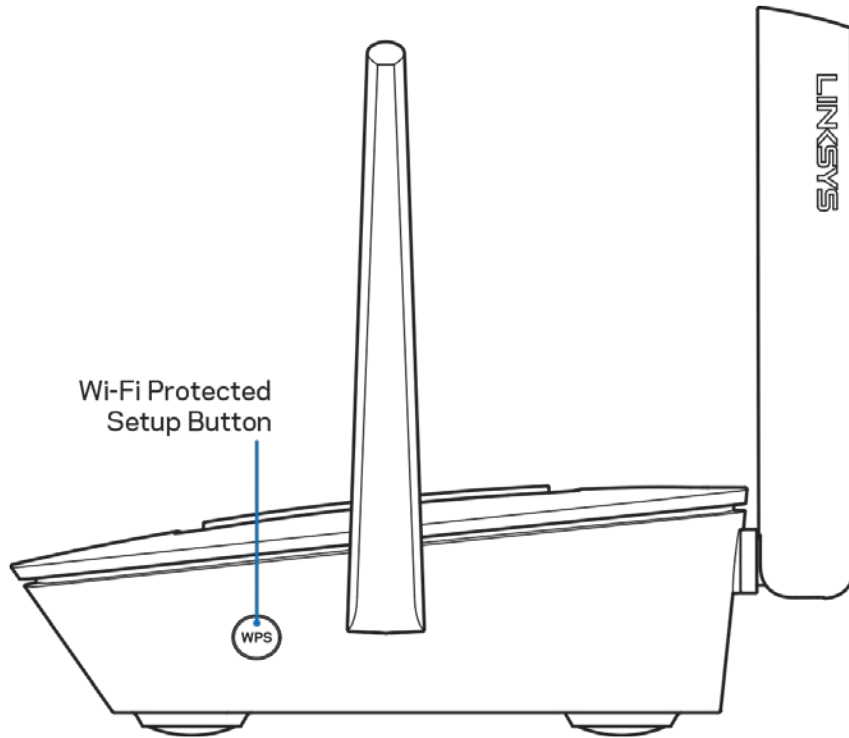

Wi-Fi Protected Setup™按鈕：按下按鈕連線至已啟用 WPS 的網路裝置。

# 設置：基本知識

## 如何尋找更多說明

除了本使用者指南外，您也可在以下位置找到更多說明：

- [Linksys.com/support/EA8300](http://Linksys.com/support/EA8300)（文件、下載、FAQ、技術支援、線上聊天、論壇）
- [Linksys Smart Wi-Fi 說明](#)（連接至 [Linksys Smart Wi-Fi](#)，然後按一下畫面頂端的「幫助」）

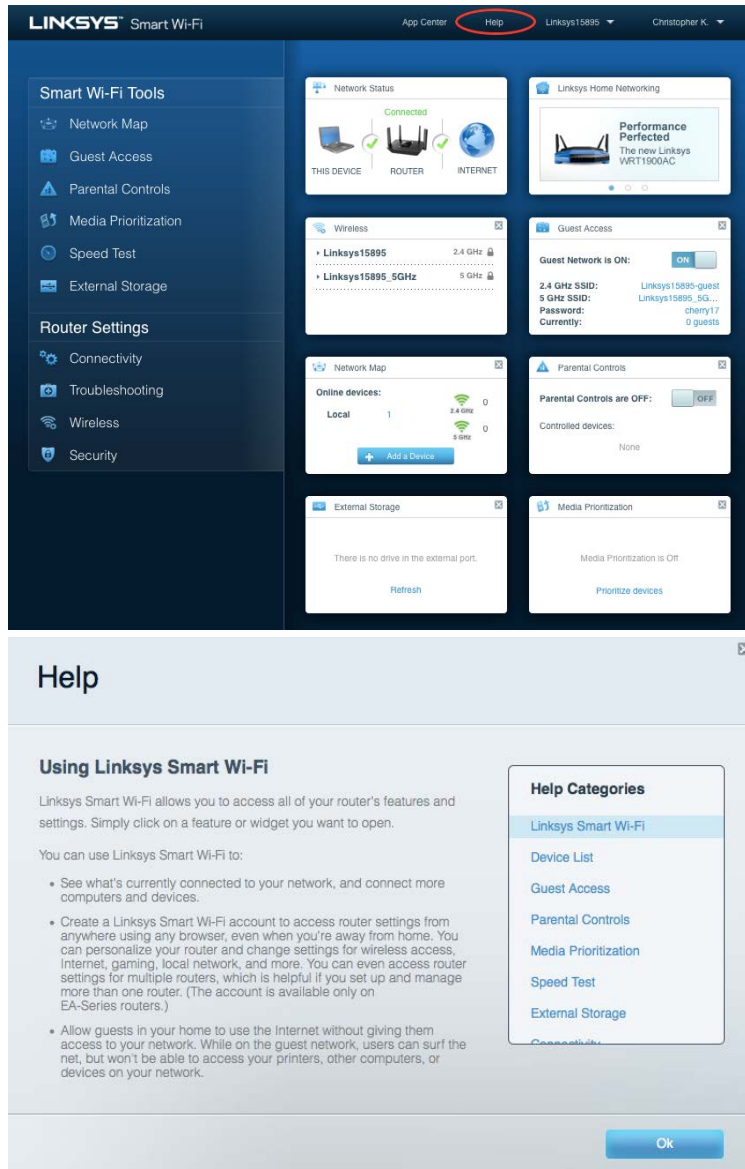

備註：您可以在下列位置檢視用於本產品的協力廠商軟體授權與注意事項：<http://support.linksys.com/en-us/licenses>。請造訪：<http://support.linksys.com/en-us/gplcodecenter>，詢問問題或請求GPL原始程式碼。

## 如何安裝您的路由器

1. 若要完成設定，您必須由電腦的網路瀏覽器造訪：<http://LinksysSmartWiFi.com>。

2. 辨識您的設備。

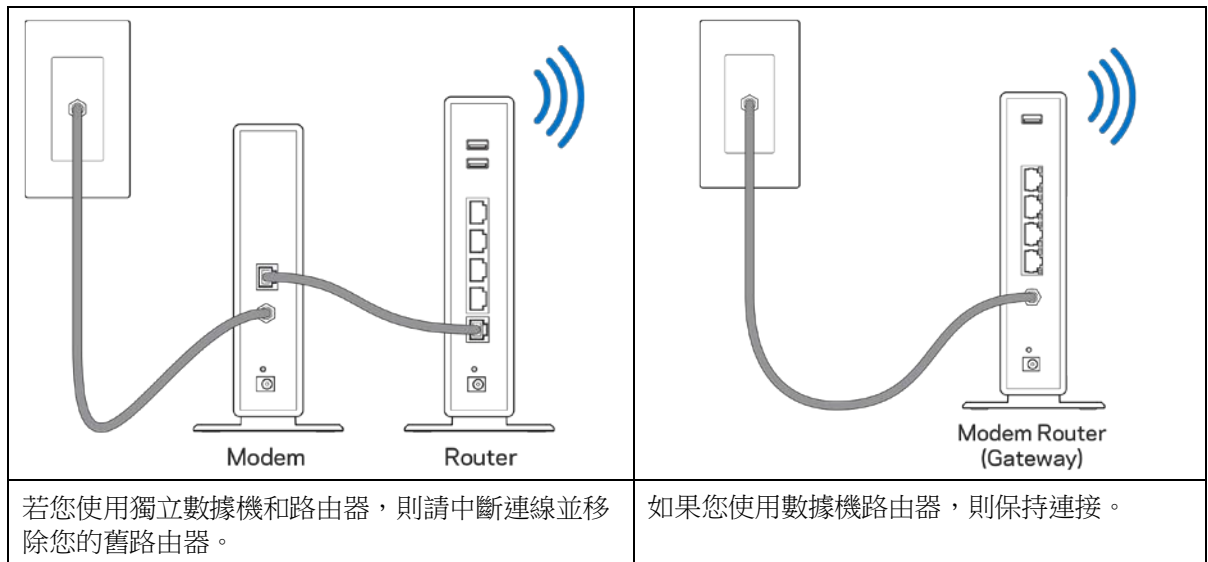

3. 如圖所示保持天線直立，並插上路由器的電源。確認電源開關位於 I (開) 位置。
4. 將路由器連接至數據機或數據機路由器。將隨附的網際網路纜線的一端連接至新路由器上的黃色網際網路連接埠。若您有數據機，請將另一端插入數據機上的乙太網路 (LAN) 連接埠。若您有數據機路由器，請插入至任意可用連接埠。
5. 請稍後至路由器上方亮起的 Linksys 指示燈停止閃爍，並保持亮白色。
6. 連接到於路由器隨附之《快速入門手冊》中所示的網路名稱。（您可以稍後更改這些細節。）如果您需要如何連接至網路的幫助，請造訪網站參閱裝置文件：[linksys.com/support/EA8300](http://linksys.com/support/EA8300)。

注意：在路由器設定完成之前，您將沒有網際網路存取。

7. 在網路瀏覽器中輸入：<http://LinksysSmartWiFi.com>。依照畫面上的指示，完成您的路由器設定。您也可以  
在瀏覽器輸入 192.168.1.1 以開始設定。

在設定操作最後，按照螢幕上的說明設定您的 Linksys Smart Wi-Fi 帳戶。您可從任何具有網際網路連線的電腦使用 Linksys Smart Wi-Fi 來設定路由器。

管理您的路由器設定：

- 更改路由器的名稱和密碼
- 設定來賓存取
- 設定家長監護功能
- 將設備連接至您的 Wi-Fi
- 測試您的網際網路連線速度

注意：在設定 Linksys Smart Wi-Fi 帳戶時，您會收到一封驗證電子郵件。請在您的家用網路中，按一下電子郵件內的連結，將您的路由器與 Linksys Smart Wi-Fi 帳戶相關聯。

秘訣 — 請列印此頁面，並在下表記下路由器與帳戶設定作為參考。請妥善保存這份筆記。

2.4 GHz Wi-Fi 名稱	
Wi-Fi 密碼	
5 GHz <sub>1</sub> Wi-Fi 名稱	
Wi-Fi 密碼	
5 GHz <sub>2</sub> Wi-Fi 名稱	
Wi-Fi 密碼	
路由器密碼	
2.4 GHz 來賓 Wi-Fi 名稱	
5GHz 來賓 Wi-Fi 名稱	
來賓 Wi-Fi 密碼（皆共享一個密碼。）	
Linksys Smart Wi-Fi 使用者名稱	
Linksys Smart Wi-Fi 密碼	

# 如何使用 Linksys Smart Wi-Fi

您可以透過 Linksys Smart Wi-Fi，隨時隨地管理您的路由器，但您也可以直接透過您的家用網路管理您的路由器。Linksys Smart Wi-Fi 也可在您的行動裝置上使用。請參閱您裝置的應用程式商店以瞭解詳情。

## 如何連線到 Linksys Smart Wi-Fi

如何連線到 Linksys Smart Wi-Fi：

1. 開啟您電腦的瀏覽器。
2. 前往 <http://LinksysSmartWiFi.com> 並登入您的帳戶。

若您不記得密碼，請按一下 *Forgot your password?*（忘記密碼？），然後依照畫面上的指示進行復原。



## 網路地圖

允許您顯示並管理所有連接到路由器的網路裝置。您可查看在您的網路和來賓網路上的各種裝置，或顯示每個裝置的資訊。



## 來賓存取權限

讓您設定並監控來賓存取 Wi-Fi 的網路，但不會透露個人資訊。

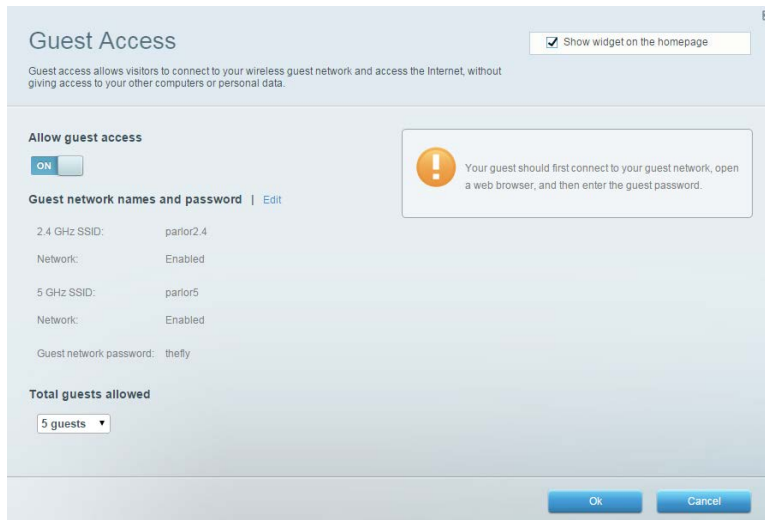

## 家長監控設定

允許您封鎖網站，並設定網際網路存取時間。

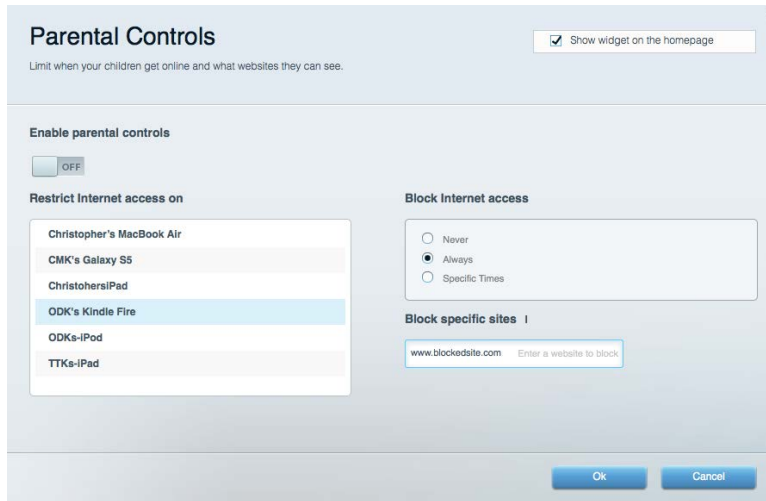

## 媒體優先順序

允許您設定哪些裝置和應用可在網路通訊中享有最高優先順序。

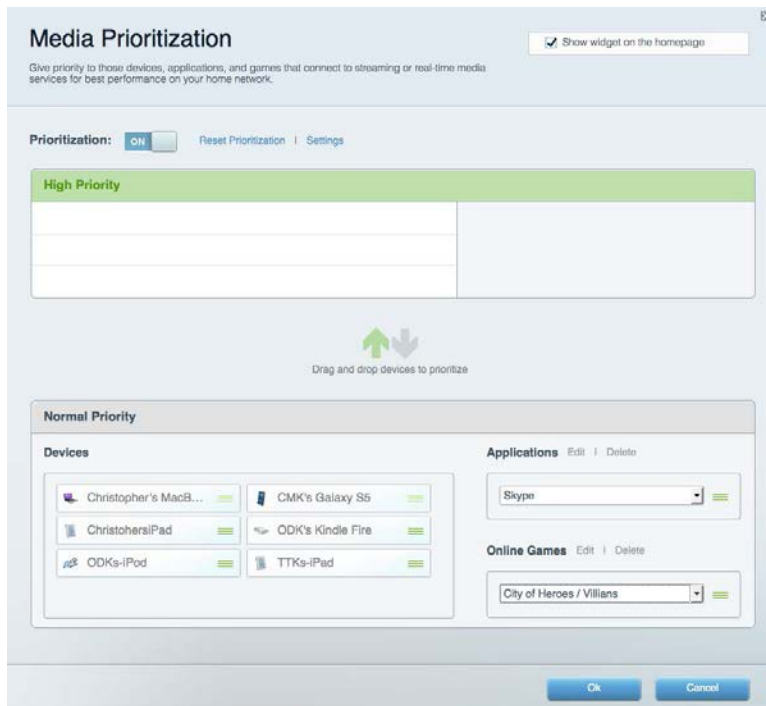

## 速度測試

允許您測試網路的網際網路連接速度。



## 外部儲存

允許您存取連接的 USB 磁碟機（未隨附），並設定檔案分享權限設定、媒體伺服器 and FTP 存取。

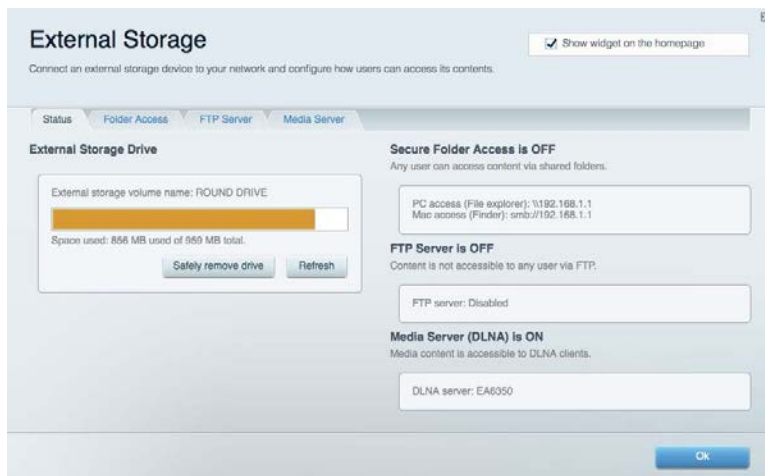

## 連線能力

讓您檢視並變更基本和進階網路設定。

The screenshot shows the 'Connectivity' settings page with the following sections:

- Network Name and Password**: 2.4 GHz network name: arachnid, Network password: peterparker; 5 GHz<sub>1</sub> + 5 GHz<sub>2</sub> network name: arachnid\_5GHz, Network password: peterparker.
- Router Password**: Router password: \*\*\*\*\*.
- Router Firmware Update**:  Automatic (Current Version: 1.1.5.164615), [Check for Updates](#).
- Time Zone**: (GMT-05:00) Eastern Time (USA & Canada),  Automatically adjust for Daylight Savings Time.
- Activity Lights**:  ON, Enable/disable activity lights. Power light will remain on.

Buttons at the bottom: [Ok](#), [Cancel](#), [Apply](#).

## 故障排除

允許您對路由器進行問題診斷並檢查網路狀態。

The screenshot shows the 'Troubleshooting' settings page with the following sections:

- Ping IPv4**: IP or host name: , Number to ping: 5, [Start to Ping](#).
- Trace route**: IP or host name: , [Start to Traceroute](#).
- Reboot**: [Reboot the router](#).
- Router configuration**: [Backup](#), [Restore](#).
- Router Firmware**: [Restore previous firmware](#).
- Internet Address**: IPv4: 10.0.0.253 [Release and Renew](#); IPv6: 2601:0540:c000:0019:0000:0000:0000:314e [Release and Renew](#).
- Factory reset**: [Reset to factory default settings](#).

Buttons at the bottom: [Ok](#).

## 無線

讓您檢視並變更路由器的無線網路。您可變更網路名稱、安全性模式、密碼、MAC 過濾，並使用 Wi-Fi Protected Setup 連接裝置。

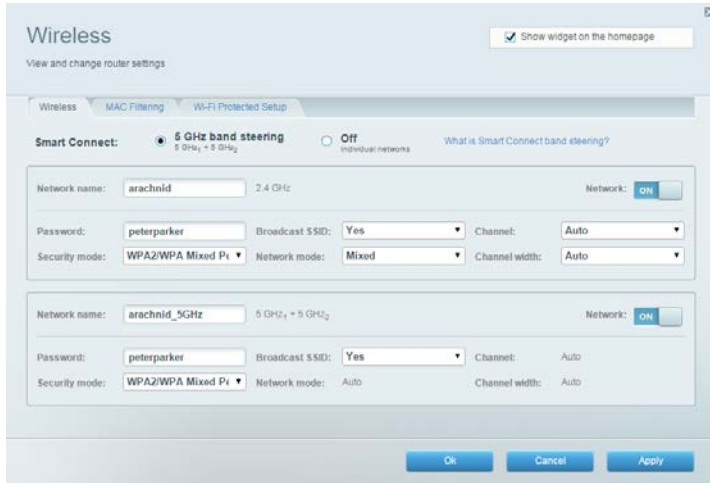

## 安全性

讓您檢視並變更路由器的無線安全性。您可以進行防火牆設定、VPN 設定，並且對各種應用程式和遊戲進行自訂設定。

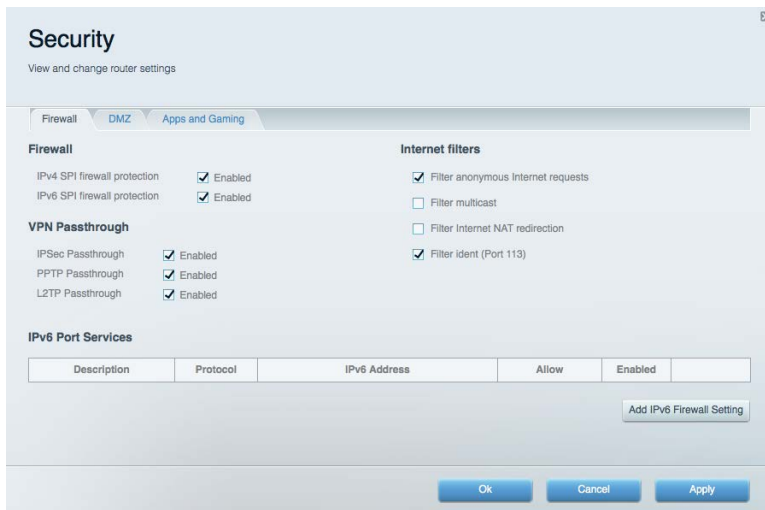

# 故障排除

您可以造訪 [linksys.com/support/EA8300](http://linksys.com/support/EA8300)，以透過我們備受讚譽的客戶支援服務獲得更多幫助。

## 您的路由器設定失敗

如果 Smart Wi-Fi 無法完成設定，您可嘗試以下操作：

- 以迴紋針或大頭針按住您路由器上的重新開機按鈕不放，直到亮起的 Linksys 徽標熄滅，且藍色 MU-MIMO 指示燈開始閃爍（約 10 秒）。重新安裝路由器。

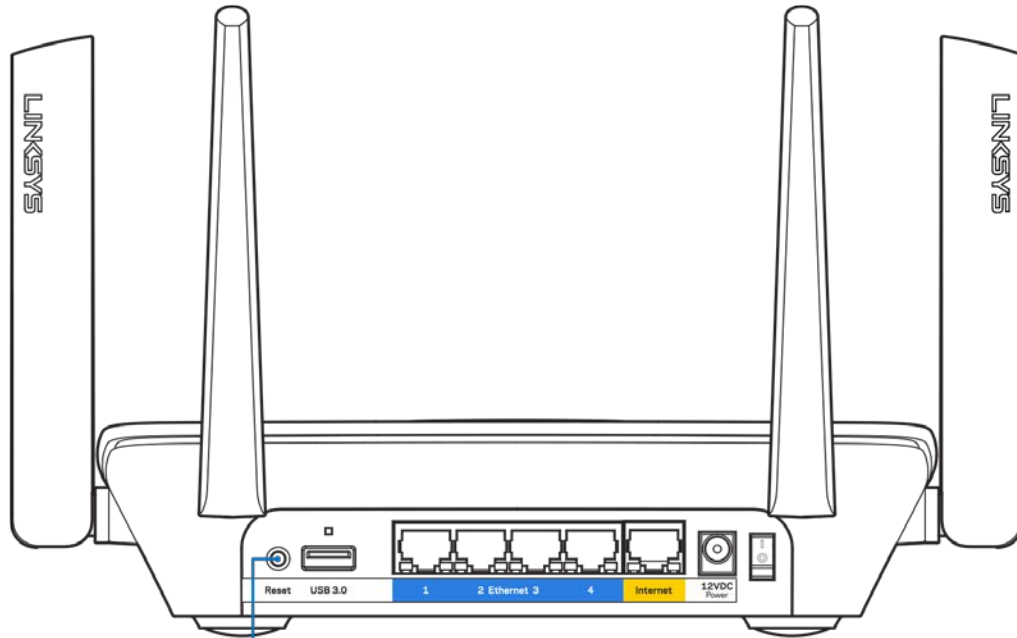

Reset Button

- 暫時停用您電腦的防火牆（請參閱安全性軟體的說明）。重新安裝路由器。
- 若您有其他台電腦，請使用該電腦來重新安裝路由器。

## 未插入網路纜線訊息

如果您在嘗試設定路由器時收到「未插入網路纜線」的訊息，請按照以下故障排除步驟進行操作。

- 請確保乙太網路或網際網路纜線（或一條類似路由器所隨附的纜線）牢固地連接到路由器背後的黃色網際網路連接埠，以及數據機的適當連接埠上。數據機的埠通常標記為乙太網埠。

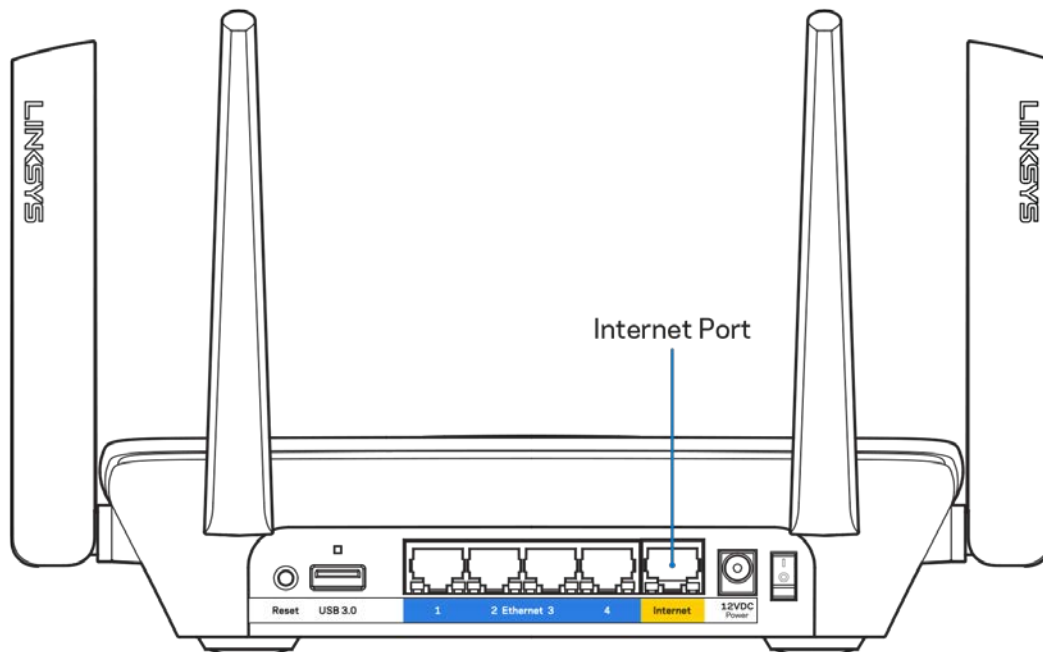

- 請確保您的數據機接上電源並處於開啟狀態。若有電源開關，請確保該開關在「開啟」或 I（而非 O）位置。

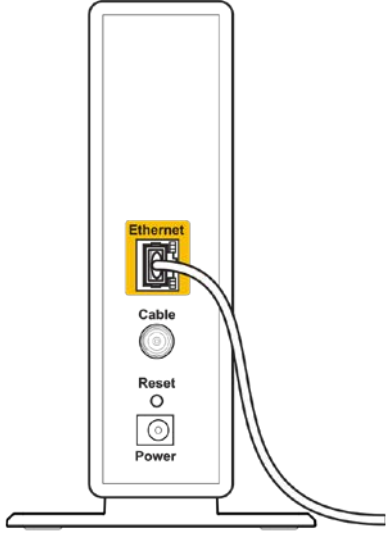
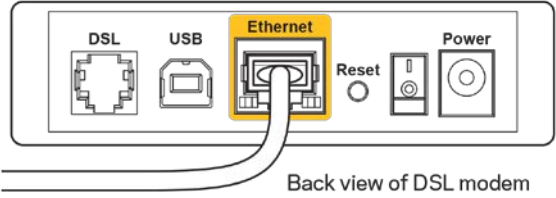
 <p style="text-align: center;">Back view of cable modem</p>	 <p style="text-align: center;">Back view of DSL modem</p>
<p>如果您的網際網路服務需連接纜線，請確認 ISP 提供的同軸電纜已連接到纜線數據機的「CABLE」連接埠上。</p>	<p>如果您的網際網路服務使用 DSL，請確認 DSL 電話線已連接到數據機的 DSL 連接埠上。</p>

- 如果您的電腦之前使用 USB 纜線連接至數據機，請中斷該 USB 纜線的連線。
- 重新安裝路由器。

## 無法存取您的路由器訊息

如需存取您的路由器，您必須連接到您自己的網路。如果您使用無線網際網路連接，問題的原因可能是您意外連接到其他無線網路。

若要在 Windows 電腦上解決此問題，請您進行下列步驟\*：

1. 按一下系統托盤中的無線圖示。隨即會顯示可用的網路清單。



- 按一下您自己的網路名稱。按一下「連線」。在下文所示的範例中，該電腦已連線到另一個名為「wraith\_5GHz」的無線網路。本範例顯示我們選擇了名為「Damaged\_Beez2.4」的 Linksys EA8300 路由器無線網路。



- 如果您收到輸入網路安全金鑰的提示，請將您的密碼（安全金鑰）輸入到網路安全金鑰對話方塊中。然後按一下「OK（確定）」。
- 您的電腦會連線至網路，現在您應可存取路由器。

\*視您的 Windows 版本而定，這些步驟的文字或圖示可能會有些許不同。

若要在 Mac 電腦上解決此問題，請您進行下列步驟：

- 在螢幕上方的功能表列中按一下 Wi-Fi 圖示。出現一個無線網路清單。
- 在下文所示的範例中，該電腦已連線到另一個名為「wraith\_5GHz」的無線網路。本範例顯示我們選擇了名為「Damaged\_Beez2.4」的 Linksys EA8300 路由器無線網路。



3. 按一下您的 Linksys EA8300 路由器的無線網路名稱（在此範例中為「Damaged\_Beez2.4」）。
4. 在「密碼」欄位中輸入您的無線網路密碼（安全金鑰）。然後按一下「OK」。

## 設定後

### 網際網路似乎無法使用

若網際網路與您的路由器通訊發生問題，您的網路瀏覽器可能會出現類似「找不到[網際網路位址]」的訊息。若您確定該網際網路位址正確，且您嘗試了數個有效的網際網路位址但卻出現一樣的訊息，這可能表示您的 ISP 或數據機在與路由器通訊時發生問題。請嘗試下列步驟：

- 確定網路纜線與電源線皆穩固連接。
- 確定路由器所插入的電源插座有通電。
- 重新啟動您的路由器。
- 聯絡您的 ISP，詢問所在區域是否有中斷情形。

最常見的解決方法是關掉路由器，然後再重新開啟。此時路由器即可載入其自訂設定，而其他裝置（例如數據機）將能重新探索路由器並與其通訊。這個程序稱為重開機。

若要使用電源線將路由器重開機，請您進行下列步驟：

1. 中斷路由器和數據機的電源線連線。
2. 等待 10 秒，然後重新連接數據機的電源線。確保通電正常。
3. 等待直到數據機的上線指示燈停止閃爍（約兩分鐘）。重新連接路由器的電源線。
4. 稍候直到亮起的 Linksys 徽標熄滅。請先等待兩分鐘，再嘗試從電腦連接至網際網路。

若要使用 Linksys Smart Wi-Fi 將路由器重開機，請您進行下列步驟：

1. 登入 Linksys Smart Wi-Fi。（請參閱第 11 頁的「如何連接到 Linksys Smart Wi-Fi」。）
2. 於 *Router Settings* (路由器設定) 下，按一下 *Troubleshooting* (故障排除)。
3. 按一下 *Diagnostics* (診斷) 索引標籤。
4. 於 *Reboot* (重開機) 下，按一下 **Reboot** (重開機)。



5. 按一下「是」(Yes)。路由器將會重開機。當路由器正在重開機時，所有連接的裝置都將喪失其網際網路連接，而在路由器就緒後就會自動重新連接。

### Linksys Smart Wi-Fi 未在您的網路瀏覽器開啟

最新版本的 Google Chrome™、Firefox®、Safari®（適用於 Mac® 與 iPad®）、Microsoft Edge 以及 Internet Explorer® 第 8 版以上等，皆與 Linksys Smart Wi-Fi 相容。

# 規格

## Linksys EA8300

型號名稱	Max-Stream AC2200 MU-MIMO 三頻路由器
型號編號	EA8300
交換器連接埠速度	10/100/1000 Mbps (Gigabit 乙太網路)
無線電頻率	2.4 GHz 與 5 GHz (x2)
天線數	4 個外部可調式天線 (不可拆卸)
連接埠	USB 3.0、乙太網路 (1-4)、網際網路、電源
按鈕	Wi-Fi Protected Setup、電源、重設
指示燈	上面板：亮起的 Linksys 徽標、Wi-Fi Protected Setup、網際網路連線、網路對網際網路連接埠電纜連線 後面板：USB 指示燈、乙太網 (1-4) 指示燈、網際網路指示燈
UPnP	支援的
安全性功能	WEP、WPA2、RADIUS
安全金鑰位元	高達 128-bit 加密
支援儲存檔案系統	FAT、NTFS 與 HFS+
支援瀏覽器	最新版本的 Google Chrome™、Firefox®、Safari® (適用於 Mac® 與 iPad®)、Microsoft Edge 以及 Internet Explorer® 第 8 版以上等

## 環境要求

尺寸	213.7mm x 161.8mm x 54.8mm (不帶天線)
本體重量	608 g
電源	12V, 2A
認證	FCC、IC、CE、Wi-Fi (a/b/g/n/ac)
操作溫度	32 至 104°F (0 至 40°C)
儲存溫度	-4 至 140°F (-20 至 60°C)
操作溼度	10% 至 80% 相對溼度，無凝結
儲存溼度	5% 至 90%，無凝結

如規格發生變化，恕不另行通知。

注意：

若需瞭解法規、保固與安全相關資訊，請查閱路由器隨附的 CD 內容，或前往：[Linksys.com/support/EA8300](http://Linksys.com/support/EA8300)。

最佳性能源自 IEEE 標準 802.11 規範。實際性能可能有所不同，包含較低無線網路容量、資料輸送率、範圍與涵蓋面。性能取決於許多因素、條件與變數，包括與存取點之間的距離、網路流量、建築材料與結構、使用作業系統、使用多種無線產品、介面與其他負面影響。

BELKIN、LINKSYS 以及許多產品名稱和標誌均屬於 Belkin 公司集團的商標。所提及的協力廠商商標均歸其各自的所有者所有。您可以在下列位置檢視用於本產品的協力廠商軟體授權與注意事項：<http://support.linksys.com/en-us/license>。請聯絡 <http://support.linksys.com/en-us/gplcodecenter> 詢問問題或索取 GPL 開放原始碼。

© 2017 Belkin International, Inc. 及其附屬公司。版權所有。

**LINKSYS®**

คู่มือผู้ใช้

**MAX-STREAM™**  
AC2200 MU-MIMO  
TRI-BAND ROUTER

รุ่น EA8300

# สารบัญ

ภาพรวมผลิตภัณฑ์.....	3
มุมมองด้านบน.....	3
ไฟแสดงสถานะระบบ .....	4
มุมมองด้านหลัง .....	5
มุมมองด้านข้าง.....	6
การตั้งค่า: ข้อมูลเบื้องต้น .....	7
มีวิธีใช้เพิ่มเติมที่ใด.....	7
วิธีการติดตั้งเราเตอร์ของคุณ .....	8
วิธีการใช้ Linksys Smart Wi-Fi .....	11
วิธีการเชื่อมต่อกับ Linksys Smart Wi-Fi .....	11
แผนผังเครือข่าย .....	12
การเข้าถึงของแอดเดสส์ Guest.....	12
การควบคุมของผู้ปกครอง.....	13
การจัดลำดับความสำคัญของสื่อจัดเก็บ .....	13
การทดสอบความเร็ว .....	14
อุปกรณ์จัดเก็บข้อมูลภายนอก .....	14
การเชื่อมต่อ .....	15
การแก้ไขปัญหา.....	15
ระบบไร้สาย .....	16
การรักษาความปลอดภัย .....	16
การแก้ไขปัญหา .....	17
การตั้งค่าเราเตอร์ของคุณไม่เสร็จสมบูรณ์.....	17
ข้อความ <i>Your Internet cable is not plugged in (คุณยังไม่ได้เสียบสายเคเบิลอินเทอร์เน็ต)</i> .....	18
ข้อความ <i>"Cannot access your router (ไม่สามารถเข้าถึงเราเตอร์ของคุณได้)"</i> .....	19
หลังการตั้งค่า.....	21
ปรากฏว่าอินเทอร์เน็ตไม่สามารถใช้งานได้ .....	21
Linksys Smart Wi-Fi ไม่เปิดในเว็บเบราว์เซอร์ของคุณ .....	21
คุณสมบัติเฉพาะ .....	22
Linksys EA8300 .....	22
คุณสมบัติภายนอก.....	22

# ภาพรวมผลิตภัณฑ์

## มุมมองด้านบน

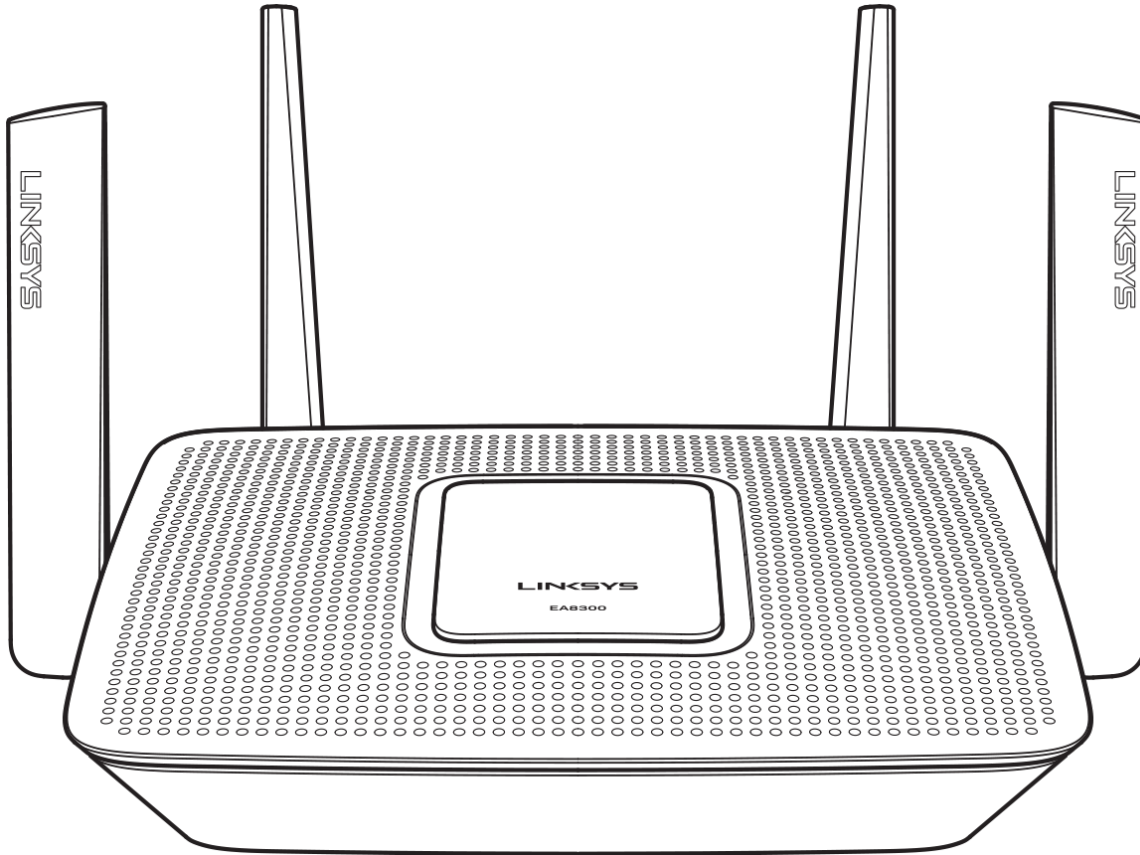

## ไฟแสดงสถานะระบบ

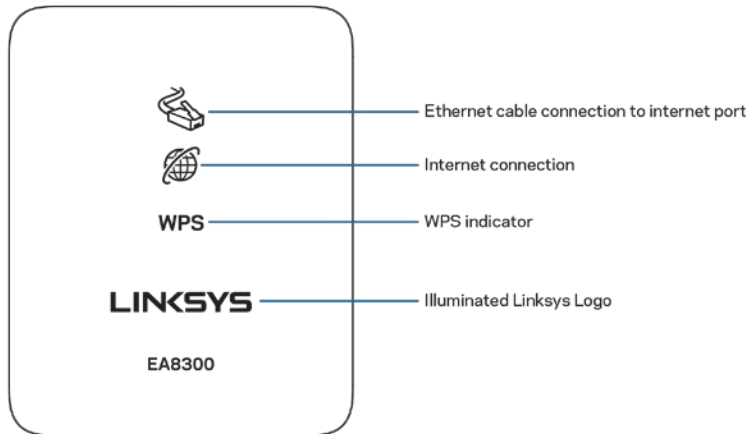

การเชื่อมต่อสายเคเบิลอีเทอร์เน็ตไปยังพอร์ตอินเทอร์เน็ต—เมื่อไฟติด (สีส้ม) แสดงว่าเกิดปัญหากับสายเคเบิลเครือข่ายที่เชื่อมต่ออยู่กับพอร์ตอินเทอร์เน็ต (WAN)

การเชื่อมต่ออินเทอร์เน็ต—เมื่อไฟติด (สีส้ม) แสดงว่าเราเตอร์ไม่สามารถเข้าถึงอินเทอร์เน็ตได้

ไฟสัญญาณ WPS (Wi-Fi Protected Setup™)—ไฟ WPS มีสี่สถานะ:

ปิด	ไม่มีการเปิดใช้งาน Wi-Fi Protected Setup
กะพริบเป็นสีขาว	กำลังดำเนินการ Wi-Fi Protected Setup
สีขาวสว่างนิ่ง	Wi-Fi Protected Setup เสร็จสมบูรณ์ ไฟจะติดอยู่ห้าวินาที
กะพริบเป็นสีส้ม	ข้อผิดพลาด Wi-Fi Protected Setup ไฟจะกะพริบเป็นเวลาหนึ่งนาทีก่อนที่จะดับไป

โลโก้ Linksys ที่ไฟติดสว่าง—โลโก้กะพริบเมื่อเราเตอร์กำลังสตาร์ท เมื่อโลโก้เป็นสีขาวสว่างนิ่ง แปลว่าเราเตอร์มีไฟเข้าและทำงานอย่างถูกต้อง



## มุมมองด้านหลัง

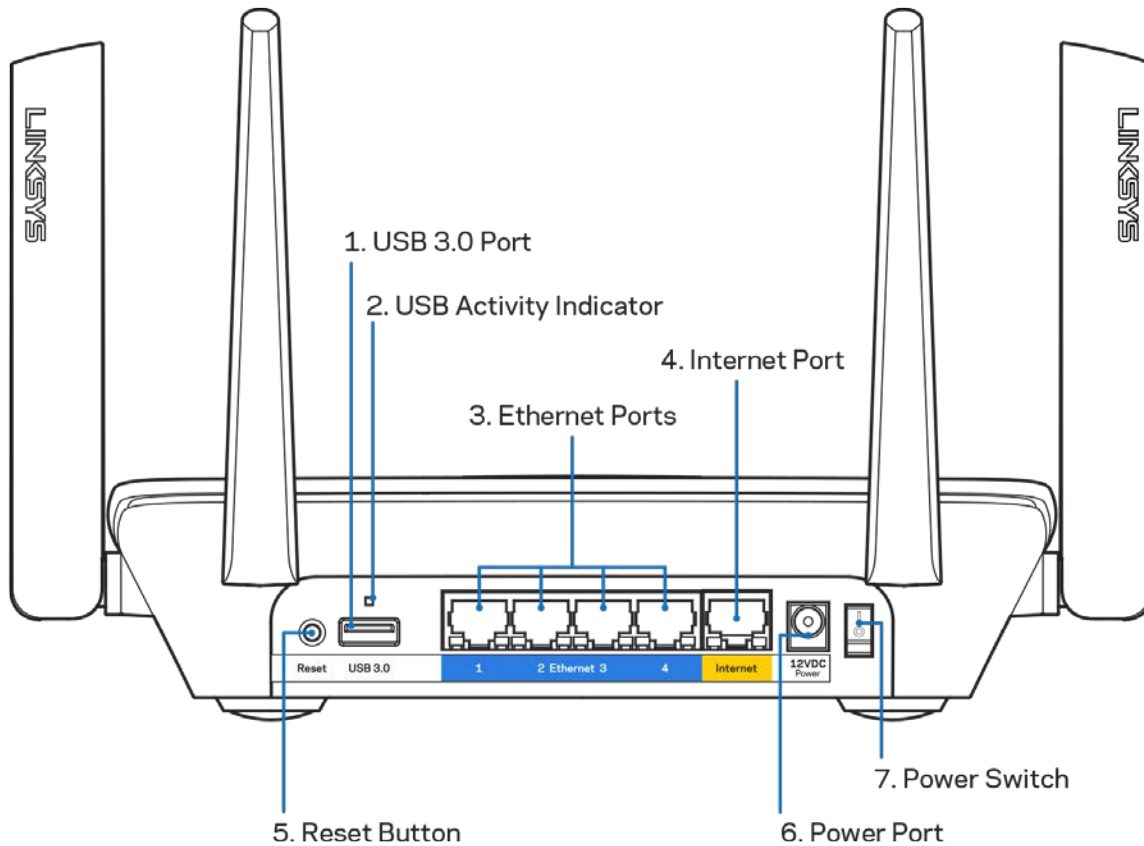

พอร์ต USB 3.0 (1)—เชื่อมต่อและใช้ไดรฟ์ USB ร่วมกันบนเครือข่ายของคุณหรือบนอินเทอร์เน็ต

ไฟแสดงสถานะการทำงานของ USB (2)—ไฟแสดงถึงการถ่ายโอนข้อมูลถึง/จากอุปกรณ์ภายนอก

พอร์ตอีเทอร์เน็ต (3)—เชื่อมต่อสายเคเบิลอีเทอร์เน็ตเข้ากับพอร์ต Gigabit (10/100/1000) สีน้ำเงิน และกับอุปกรณ์ผ่านสายบนเครือข่ายของคุณ

**หมายเหตุ**—เพื่อประสิทธิภาพการทำงานที่ดีที่สุด ให้ใช้ CAT5e หรือสายเคเบิลที่มีอัตราที่สูงกว่าบนพอร์ตอีเทอร์เน็ต

พอร์ตอินเทอร์เน็ต (4)—เชื่อมต่อสายเคเบิลอีเทอร์เน็ตเข้ากับพอร์ต Gigabit (10/100/1000) สีเหลืองนี้ และกับสายเคเบิลอินเทอร์เน็ตบรอดแบนด์/DSL หรือโมเด็มไฟเบอร์

**หมายเหตุ**—เพื่อประสิทธิภาพการทำงานที่ดีที่สุด ให้ใช้ CAT5e หรือสายเคเบิลที่มีอัตราที่สูงกว่าบนพอร์ตอีเทอร์เน็ต

ปุ่มรีเซ็ต (5)—กดปุ่มนี้ค้างไว้จนกว่าโลโก้ Linksys ที่สว่างอยู่จะดับลงเพื่อรีเซ็ตเราเตอร์ให้เป็นค่าจากโรงงาน คุณสามารถเรียกคืนค่าดีฟอลต์จากโรงงานโดยใช้ Linksys Smart Wi-Fi บนอินเทอร์เน็ตหรือแอปพลิเคชันมือถือได้ด้วย

พอร์ตจ่ายไฟ (6)—เชื่อมต่ออะแดปเตอร์ AC ที่ให้มา

สวิตช์เปิด/ปิด (7)—กด | (เปิด) เพื่อเปิดเราเตอร์

## มุมมองด้านข้าง

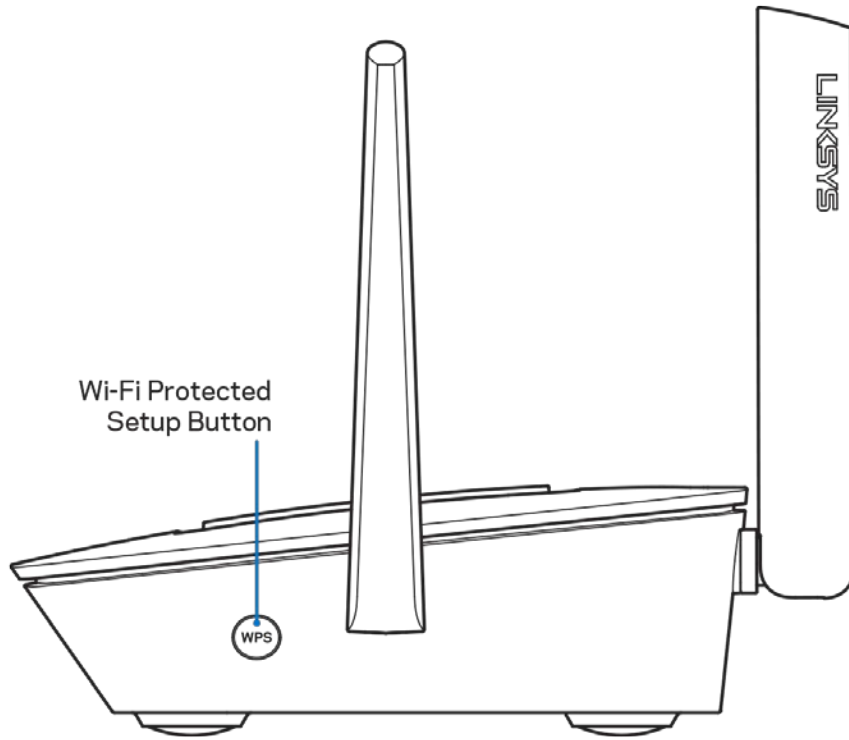

ปุ่ม Wi-Fi Protected Setup™—กดเพื่อเชื่อมต่อกับอุปกรณ์เครือข่ายที่เปิดใช้งาน WPS

# การตั้งค่า: ข้อมูลเบื้องต้น

## มีวิธีใช้เพิ่มเติมที่ใด

นอกเหนือจากคู่มือผู้ใช้เล่มนี้ คุณสามารถค้นหาวิธีใช้ได้จาก:

- [Linksys.com/support/EA8300](http://Linksys.com/support/EA8300) (เอกสาร ดาวนโหลดสื่อ คำถามที่ถามบ่อย การสนับสนุนด้านเทคนิค สนทนาสด ฟอรัม)
- วิธีใช้ Linksys Smart Wi-Fi (เชื่อมต่อกับ Linksys Smart Wi-Fi แล้วคลิกวิธีใช้ที่ด้านบนของหน้าจอ)

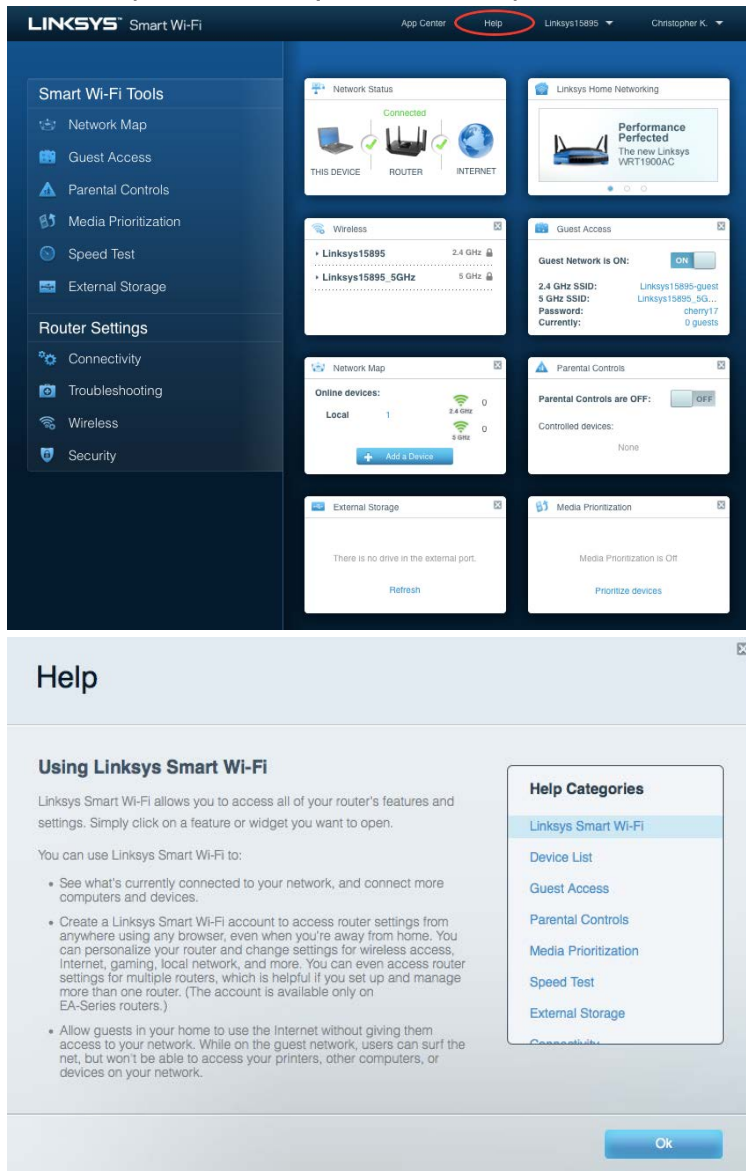

หมายเหตุ—สามารถอ่านลิขสิทธิ์และประกาศเกี่ยวกับซอฟต์แวร์บุคคลภายนอกในผลิตภัณฑ์นี้ได้ที่ <http://support.linksys.com/en-us/license> โปรดติดต่อ <http://support.linksys.com/en-us/gplcodecenter> หากมีคำถามหรือต้องการร้องขอซอร์สโค้ด GPL

## วิธีการติดตั้งเราเตอร์ของคุณ

1. เพื่อทำการตั้งค่าให้เสร็จสมบูรณ์ คุณต้องใช้คอมพิวเตอร์เพื่อไปที่ <http://LinksysSmartWiFi.com> ในเว็บเบราว์เซอร์
2. ระบุอุปกรณ์ของคุณ

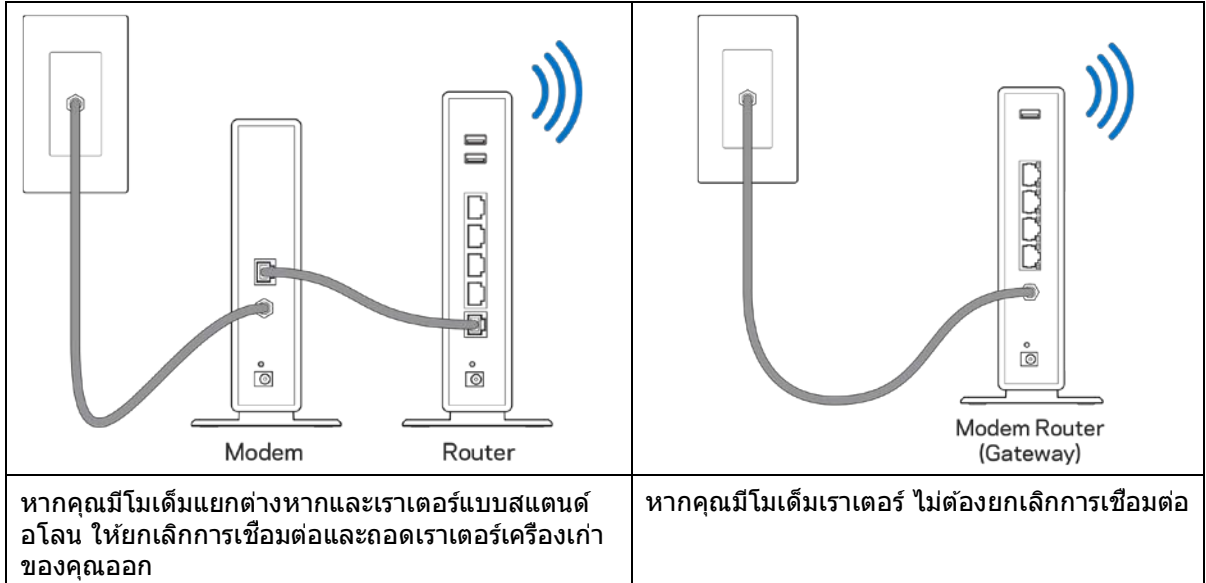

3. หมุนเสาอากาศให้ชี้ตรงขึ้นด้านบนและเสียบปลั๊กเราเตอร์เข้ากับแหล่งพลังงาน ตรวจสอบให้แน่ใจว่าสวิตช์เปิด/ปิด อยู่ในตำแหน่ง | (เปิด)
4. เชื่อมต่อเราเตอร์ของคุณเข้ากับโมเด็มหรือโมเด็มเราเตอร์ เสียบปลายด้านหนึ่งของสายเคเบิลอินเทอร์เน็ตที่นำมาด้วยเข้ากับพอร์ตอินเทอร์เน็ตสีเหลืองบนเราเตอร์เครื่องใหม่ของคุณ หากคุณมีโมเด็ม ให้เสียบปลายอีกข้างเข้ากับพอร์ตอีเทอร์เน็ต (LAN) บนโมเด็ม หากคุณมีโมเด็มเราเตอร์ ให้เสียบเข้าไปที่พอร์ตใดก็ได้ที่ว่างอยู่
5. รอจนกว่าไฟ Linksys บนเราเตอร์ของคุณจะหยุดกะพริบและสว่างนิ่งเป็นสีขาว
6. เชื่อมต่อไปยังชื่อ Wi-Fi ซึ่งปรากฏอยู่ในคู่มือการเริ่มต้นฉบับย่อที่มาพร้อมกับเราเตอร์ของคุณ (คุณสามารถเปลี่ยนรายละเอียดเหล่านี้ได้ในภายหลัง) หากคุณต้องการความช่วยเหลือในการเชื่อมต่อกับเครือข่าย โปรดดูเอกสารประกอบอุปกรณ์ของคุณได้ที่ [linksys.com/support/EA8300](http://linksys.com/support/EA8300)

**หมายเหตุ—คุณจะไม่สามารถใช้งานอินเทอร์เน็ตได้จนกว่าการตั้งค่าเราเตอร์จะเสร็จสมบูรณ์**

7. ป้อน <http://LinksysSmartWiFi.com> ในเว็บเบราว์เซอร์ ทำตามคำแนะนำบนหน้าจอเพื่อดึงค่าเราเตอร์ของคุณให้เสร็จสมบูรณ์ นอกจากนี้คุณยังสามารถพิมพ์ 192.168.1.1 ในเบราว์เซอร์เพื่อเริ่มการตั้งค่า

ในตอนท้ายของการตั้งค่า ให้ทำตามคำแนะนำบนหน้าจอเพื่อตั้งค่าแอคเคาท์ Linksys Smart Wi-Fi ใช้ Linksys Smart Wi-Fi เพื่อตั้งค่าเราเตอร์ของคุณจากคอมพิวเตอร์เครื่องใดก็ได้ที่มีการเชื่อมต่ออินเทอร์เน็ต

จัดการการตั้งค่าเราเตอร์ของคุณ:

- เปลี่ยนแปลงชื่อและรหัสผ่านเราเตอร์
- ตั้งค่าการเข้าถึงของแอคเคาท์ Guest
- กำหนดค่าการควบคุมของผู้ปกครอง
- เชื่อมต่ออุปกรณ์ไปยัง Wi-Fi ของคุณ
- ทดสอบความเร็วในการเชื่อมต่ออินเทอร์เน็ตของคุณ

หมายเหตุ—คุณจะได้รับอีเมลการตรวจสอบ ซึ่งเป็นส่วนหนึ่งของการตั้งค่าแอคเคาท์ Linksys Smart Wi-Fi จากเครือข่ายในบ้านของคุณ ให้คลิกลิงก์ในอีเมลของคุณเพื่อเชื่อมโยงเราเตอร์กับแอคเคาท์ Linksys Smart Wi-Fi

เคล็ดลับ—พิมพ์หน้าถัดไป แล้วบันทึกเราเตอร์และการตั้งค่าแอคเคาท์ของคุณในตารางนี้เป็นข้อมูลอ้างอิง เก็บบันทึกย่อของคุณไว้ในที่ที่ปลอดภัย

ชื่อ Wi-Fi 2.4 GHz	
รหัสผ่าน Wi-Fi	
ชื่อ Wi-Fi 5 GHz <sub>1</sub>	
รหัสผ่าน Wi-Fi	
ชื่อ Wi-Fi 5 GHz <sub>2</sub>	
รหัสผ่าน Wi-Fi	
รหัสผ่านของเราเตอร์	
ชื่อ Wi-Fi สำหรับแอดเดสส์ เคาท์ Guest 2.4 GHz	
ชื่อ Wi-Fi สำหรับแอดเดสส์ เคาท์ Guest 5 GHz	
รหัสผ่าน Wi-Fi สำหรับ แอดเดสส์ Guest (ใช้ รหัสผ่านร่วมกัน)	
ชื่อผู้ใช้ Linksys Smart Wi-Fi	
รหัสผ่าน Linksys Smart Wi-Fi	

# วิธีการใช้ Linksys Smart Wi-Fi

คุณสามารถจัดการเราเตอร์ของคุณจากที่ใดก็ได้ในโลกโดยใช้ Linksys Smart Wi-Fi และคุณยังสามารถจัดการได้จากเครือข่ายในบ้านของคุณโดยตรงอีกด้วย Linksys Smart Wi-Fi อาจใช้งานกับอุปกรณ์เคลื่อนที่ของคุณได้ด้วยเช่นกัน ดู App Store ของอุปกรณ์ของคุณสำหรับข้อมูลเพิ่มเติม

## วิธีการเชื่อมต่อกับ Linksys Smart Wi-Fi

เพื่อเชื่อมต่อกับ Linksys Smart Wi-Fi:

1. เปิดเว็บเบราว์เซอร์ของคอมพิวเตอร์ของคุณ
2. ไปที่ <http://LinksysSmartWiFi.com> และล็อกอินเข้าสู่แอคเคาท์ของคุณ

หากคุณจำรหัสผ่านของคุณไม่ได้ ให้คลิก *Forgot your password?* (*ลืมรหัสผ่าน?*) และทำตามคำแนะนำที่ปรากฏบนหน้าจอเพื่อกู้คืน

## แผนผังเครือข่าย

ช่วยให้คุณสามารถเรียกดูและจัดการอุปกรณ์เครือข่ายทั้งหมดที่เชื่อมต่อกับเราเตอร์ของคุณ คุณสามารถดูอุปกรณ์บนเครือข่ายหลักและเครือข่ายแอดเคาท์ Guest ของคุณ หรือแสดงข้อมูลเกี่ยวกับแต่ละอุปกรณ์ได้



## การเข้าถึงของแอดเคาท์ Guest

ช่วยให้คุณตั้งค่าและติดตามเครือข่ายแอดเคาท์ Guest ให้เข้าถึง Wi-Fi โดยไม่เปิดเผยข้อมูลส่วนตัว

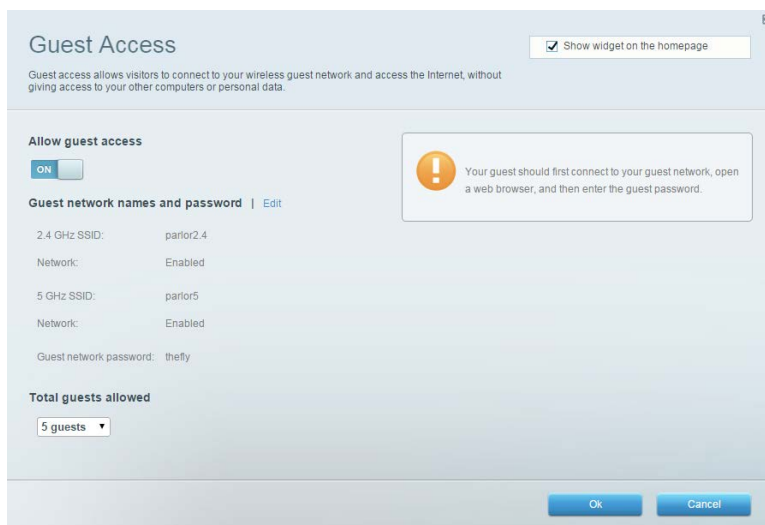



## การควบคุมของผู้ปกครอง

ช่วยให้คุณสามารถบล็อกเว็บไซต์และตั้งเวลาการเข้าใช้งานอินเทอร์เน็ต

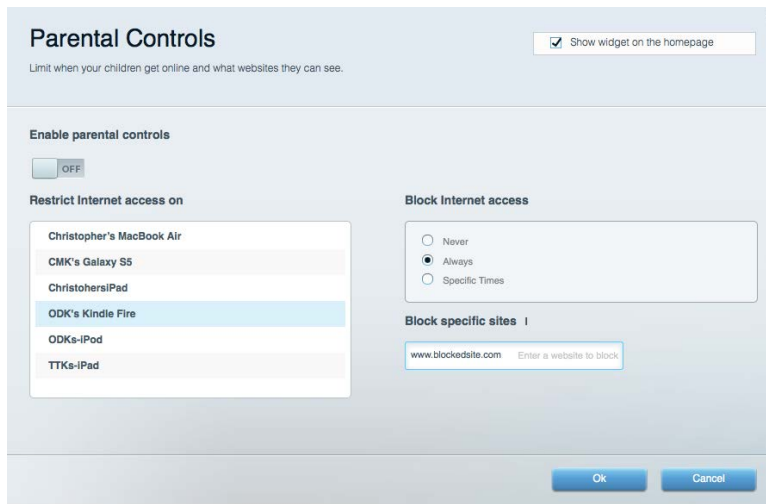

## การจัดลำดับความสำคัญของสื่อจัดเก็บ

ช่วยให้คุณสามารถตั้งค่าได้ว่าอุปกรณ์และแอปพลิเคชันใดที่มีความสำคัญสูงสุดสำหรับการรับส่งข้อมูลในเครือข่าย

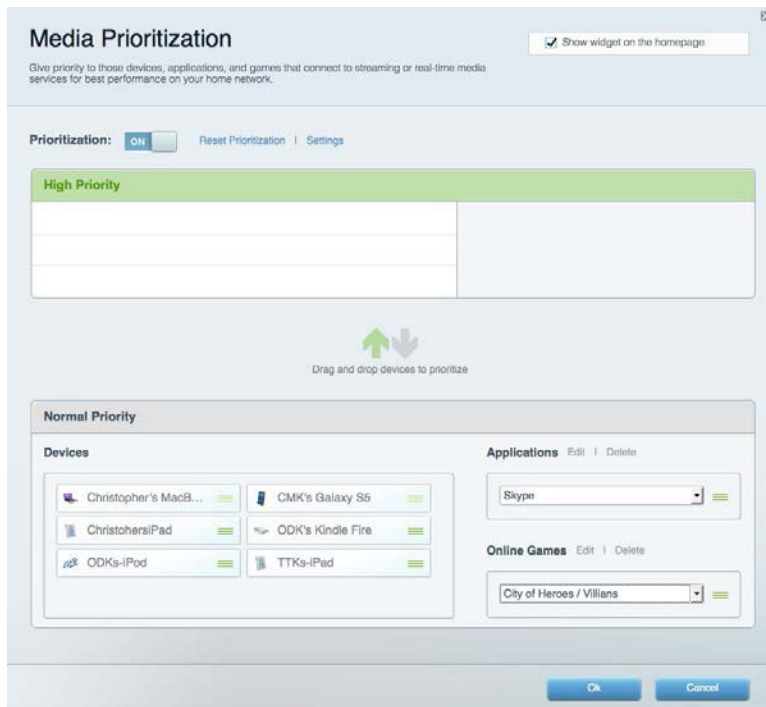

## การทดสอบความเร็ว

ช่วยให้คุณทดสอบความเร็วในการเชื่อมต่ออินเทอร์เน็ตของเครือข่ายของคุณได้



## อุปกรณ์จัดเก็บข้อมูลภายนอก

ช่วยให้คุณเข้าถึงไดรฟ์ USB (ไม่ได้ให้มาด้วย) และตั้งค่าการใช้ไฟล์ร่วมกัน, Media Server และการเข้าถึง FTP ได้



## การเชื่อมต่อ

ช่วยให้คุณสามารถดูและเปลี่ยนแปลงการตั้งค่าเครือข่ายขั้นสูงและขั้นพื้นฐานได้

Connectivity  
View and change router settings

Basic Internet Settings Local Network Advanced Routing VLAN Administration

Network Name and Password | Edit

2.4 GHz network name: arachnid  
Network password: peterparker

5 GHz<sub>1</sub> + 5 GHz<sub>2</sub> network name: arachnid\_5GHz  
Network password: peterparker

Router Password | Edit

Router password: \*\*\*\*\*

Router Firmware Update

Automatic (Current Version: 1.1.5.164615)  
Check for Updates

Time Zone

(GMT-05:00) Eastern Time (USA & Canada)

Automatically adjust for Daylight Savings Time

Activity Lights

ON  Enable/disable activity lights. Power light will remain on.

Ok Cancel Apply

## การแก้ไขปัญหา

ช่วยให้คุณสามารถวินิจฉัยปัญหาที่เกิดขึ้นกับเราเตอร์ของคุณและตรวจสอบสถานะของเครือข่ายได้

Troubleshooting  
Troubleshoot router settings

Status Diagnostics Logs

Ping IPv4

IP or host name:   
Number to ping: 5  
Start to Ping

Trace route

IP or host name:   
Start to Traceroute

Reboot

Reboot the router

Router configuration

Backup Restore

Router Firmware

Restore previous firmware

Internet Address:

IP4: 10.0.0.253 Release and Renew  
IP6: 2601:0540::000:0019:0000:0000:0000:314e Release and Renew

Factory reset

Reset to factory default settings

Ok

## ระบบไร้สาย

ช่วยให้คุณสามารถดูและเปลี่ยนแปลงเครือข่ายแบบไร้สายของเราเตอร์ของคุณได้ คุณสามารถเปลี่ยนชื่อเครือข่าย โหมดการรักษาความปลอดภัย, รหัสผ่าน, การกรอง MAC และเชื่อมต่ออุปกรณ์ด้วย Wi-Fi Protected Setup ได้

Wireless

View and change router settings

Wireless MAC Filtering Wi-Fi Protected Setup

Smart Connect:  5 GHz band steering  Off

Network name: arachnid 2.4 GHz Network: ON

Password: peterparker Broadcast SSID: Yes Channel: Auto

Security mode: WPA2/WPA Mixed P Network mode: Mixed Channel width: Auto

Network name: arachnid\_5GHz 5 GHz<sub>1</sub> + 5 GHz<sub>2</sub> Network: ON

Password: peterparker Broadcast SSID: Yes Channel: Auto

Security mode: WPA2/WPA Mixed P Network mode: Auto Channel width: Auto

Ok Cancel Apply

## การรักษาความปลอดภัย

ช่วยให้คุณสามารถดูและเปลี่ยนแปลงการรักษาความปลอดภัยแบบไร้สายของเราเตอร์ของคุณได้ คุณสามารถตั้งค่าไฟร์วอลล์, การตั้งค่า VPN และทำการตั้งค่าเฉพาะสำหรับแอปพลิเคชันและเกม

Security

View and change router settings

Firewall DMZ Apps and Gaming

Firewall

IPv4 SPI firewall protection  Enabled

IPv6 SPI firewall protection  Enabled

VPN Passthrough

IPSec Passthrough  Enabled

PPTP Passthrough  Enabled

L2TP Passthrough  Enabled

Internet filters

Filter anonymous Internet requests

Filter multicast

Filter Internet NAT redirection

Filter ident (Port 113)

IPv6 Port Services

Description	Protocol	IPv6 Address	Allow	Enabled

Add IPv6 Firewall Setting

Ok Cancel Apply

# การแก้ไขปัญหา

คุณสามารถรับความช่วยเหลือเพิ่มเติมจากฝ่ายบริการลูกค้าที่ได้รับรางวัลของเราได้ที่ [linksys.com/support/EA8300](https://linksys.com/support/EA8300)

## การตั้งค่าเราเตอร์ของคุณไม่เสร็จสมบูรณ์

หาก Linksys Smart Wi-Fi ไม่ได้ตั้งค่าให้เสร็จสมบูรณ์ คุณสามารถลองใช้วิธีต่อไปนี้:

- กดปุ่มรีเซ็ตบนเราเตอร์ของคุณค้างไว้โดยใช้คลิปหนีบกระดาษหรือเข็มหมุด จนกว่าโลโก้ Linksys ที่สว่างอยู่จะดับลง และไฟแสดงสถานะ MU-MIMO สีน้ำเงินจะเริ่มกะพริบ (ประมาณ 10 วินาที) ติดตั้งเราเตอร์อีกครั้ง

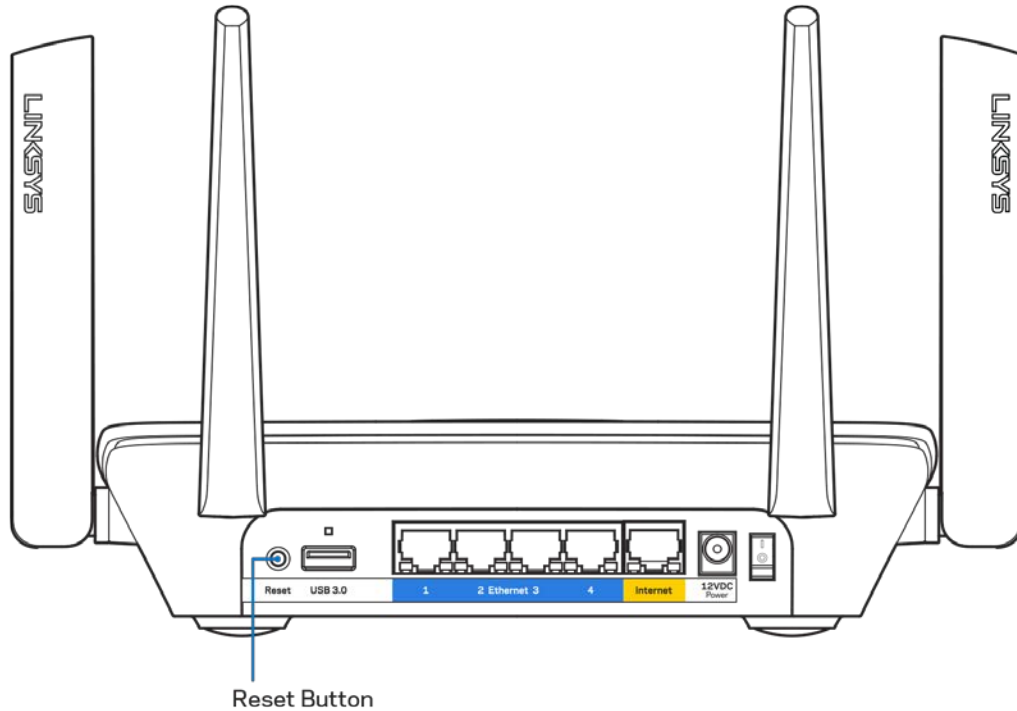

- ปิดการใช้งานไฟร็วอลล์ซ์ของคอมพิวเตอร์ของคุณชั่วคราว (หากต้องการความช่วยเหลือ ดูคำแนะนำของซอฟต์แวร์การรักษาความปลอดภัย) ติดตั้งเราเตอร์อีกครั้ง
- หากคุณมีคอมพิวเตอร์เครื่องอื่น ให้ใช้คอมพิวเตอร์นั้นเพื่อติดตั้งเราเตอร์อีกครั้ง

## ข้อความ *Your Internet cable is not plugged in (คุณยังไม่ได้เสียบสายเคเบิลอินเทอร์เน็ต)*

หากคุณได้รับข้อความ "Your Internet cable is not plugged in (คุณยังไม่ได้เสียบสายเคเบิลอินเทอร์เน็ต)" ขณะพยายามตั้งค่าเราเตอร์ของคุณ ให้ทำตามขั้นตอนการแก้ไขปัญหาต่อไปนี้

- ตรวจสอบให้แน่ใจว่าสายเคเบิลอีเทอร์เน็ตหรืออินเทอร์เน็ต (หรือสายเคเบิลแบบเดียวกับที่นำมาให้เราเตอร์ของคุณ) เชื่อมต่อกับพอร์ตอินเทอร์เน็ตสีเหลืองที่ด้านหลังของเราเตอร์และกับพอร์ตที่เหมาะสมบนโมเด็มของคุณแน่นดีแล้ว โดยปกติพอร์ตบนโมเด็มจะมีป้ายกำกับว่าอีเทอร์เน็ต

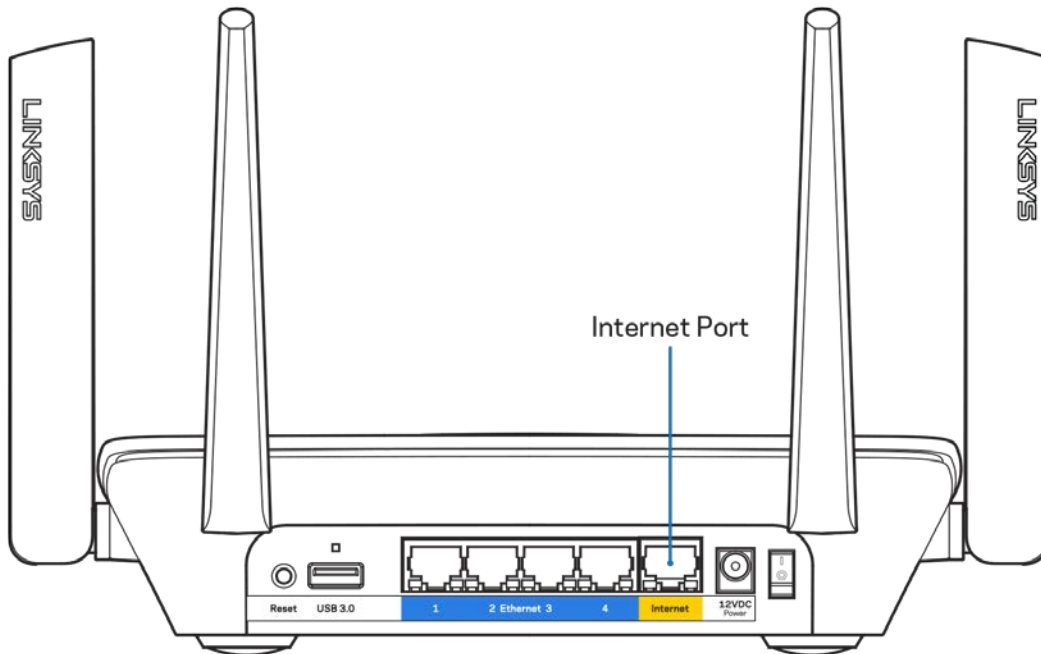

- ตรวจสอบให้แน่ใจว่าโมเด็มของคุณเชื่อมต่อกับสายไฟและเปิดเครื่องอยู่ หากโมเด็มมีสวิตช์เปิด/ปิด ดูให้แน่ใจว่ากดสวิตช์เป็นตำแหน่ง ON หรือ | (ซึ่งตรงข้ามกับ O)

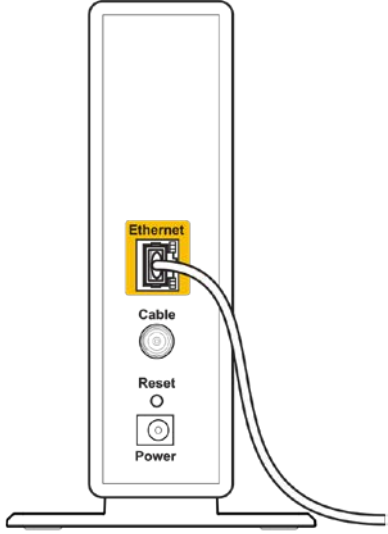
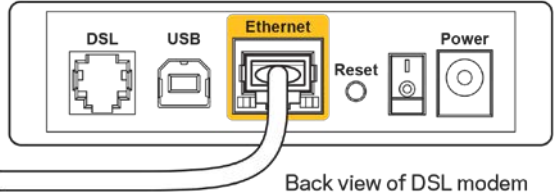
 <p>Back view of cable modem</p>	 <p>Back view of DSL modem</p>
<p>หากคุณใช้บริการอินเทอร์เน็ตผ่านสายเคเบิล ตรวจสอบว่าพอร์ต CABLE ของเคเบิลโมเด็มนั้นเชื่อมต่อกับสายเคเบิล Coax ที่ ISP ของคุณจัดเตรียมให้</p>	<p>หากบริการอินเทอร์เน็ตของคุณคือ DSL ตรวจสอบให้แน่ใจว่าสายโทรศัพท์ DSL เชื่อมต่อกับพอร์ต DSL ของโมเด็ม</p>

- หากก่อนหน้านี้ คอมพิวเตอร์ของคุณเชื่อมต่อกับโมเด็มของคุณด้วยสาย USB ให้ยกเลิกการเชื่อมต่อสาย USB
- ติดตั้งเราเตอร์อีกครั้ง

## ข้อความ "Cannot access your router (ไม่สามารถเข้าถึงเราเตอร์ของคุณได้)"

ในการเข้าถึงเราเตอร์ของคุณ คุณต้องเชื่อมต่อกับเครือข่ายของคุณเอง หากคุณมีการเข้าใช้งานอินเทอร์เน็ตแบบไร้สาย ปัญหาอาจเกิดขึ้นจากการที่เชื่อมต่อกับเครือข่ายไร้สายอื่นโดยบังเอิญ

เมื่อต้องการแก้ปัญหาบนคอมพิวเตอร์ที่ใช้ Windows ให้ทำดังนี้\*:

1. คลิกบนไอคอนการเชื่อมต่อแบบไร้สายในถาดระบบ รายการเครือข่ายที่พร้อมใช้งานจะปรากฏขึ้น

- คลิกชื่อเครือข่ายของตนเอง คลิก Connect (เชื่อมต่อ) ในตัวอย่างด้านล่างนี้ คอมพิวเตอร์จะเชื่อมต่อกับเครือข่ายไร้สายอื่นที่ชื่อว่า wraith\_5GHz ชื่อเครือข่ายไร้สายของเราเตอร์ Linksys EA8300 ซึ่งในตัวอย่างนี้คือ Damaged\_Beez2.4 จะแสดงว่าถูกเลือกไว้



- ถ้าคุณต้องป้อนคีย์การรักษาความปลอดภัยของเครือข่าย ให้พิมพ์รหัสผ่านของคุณ (คีย์การรักษาความปลอดภัย) ลงในฟิลด์ network security key (คีย์การรักษาความปลอดภัยของเครือข่าย) คลิก OK (ตกลง)
- คอมพิวเตอร์ของคุณจะเชื่อมต่อกับเครือข่าย และคุณสามารถเข้าถึงเราเตอร์ได้

\*อาจมีความแตกต่างบางประการในการใช้คำหรือไอคอนในขั้นตอนต่อไปนี้ ทั้งนี้ขึ้นอยู่กับรุ่นของ Windows ของคุณ

เมื่อต้องการแก้ปัญหาบนคอมพิวเตอร์ที่ใช้ Mac ให้ทำดังนี้:

- ให้คลิกที่ไอคอน Wi-Fi ในแถบเมนูที่ด้านบนของหน้าจอ รายการเครือข่ายไร้สายจะปรากฏขึ้น
- ในตัวอย่างด้านล่างนี้ คอมพิวเตอร์จะเชื่อมต่อกับเครือข่ายไร้สายอื่นที่ชื่อว่า wraith\_5GHz ชื่อเครือข่ายไร้สายของเราเตอร์ Linksys EA8300 ซึ่งในตัวอย่างนี้คือ Damaged\_Beez2.4 จะแสดงว่าถูกเลือกไว้





3. คลิกชื่อเครือข่ายไร้สายของเราเตอร์ Linksys EA8300 (Damaged\_Beez2.4 ในตัวอย่างนี้)
4. พิมพ์รหัสผ่านเครือข่ายไร้สาย (คีย์การรักษาความปลอดภัย) ลงในฟิลด์ Password (รหัสผ่าน) คลิก OK (ตกลง)

## หลังการตั้งค่า

### ปรากฏว่าอินเทอร์เน็ตไม่สามารถใช้งานได้

ถ้าอินเทอร์เน็ตมีปัญหาในการสื่อสารกับเราเตอร์ของคุณ ปัญหาอาจปรากฏเป็นข้อความ "Cannot find (ไม่พบ) [ที่อยู่อินเทอร์เน็ต]" ในเว็บเบราว์เซอร์ของคุณ หากคุณทราบว่าที่อยู่อินเทอร์เน็ตนั้นถูกต้อง และถ้าคุณลองใช้ที่อยู่อินเทอร์เน็ตที่ถูกต้องแล้วได้ผลเหมือนเดิม ข้อความนั้นอาจหมายความว่าปัญหาเกิดขึ้นกับผู้ให้บริการอินเทอร์เน็ตของคุณหรือโมเด็มที่สื่อสารกับเราเตอร์ของคุณ ให้ลองทำดังนี้:

- ตรวจสอบให้แน่ใจว่าได้เสียบสายเคเบิลเครือข่ายและสายไฟแนตแล้ว
- ตรวจสอบให้แน่ใจว่าเต้ารับที่เราเตอร์ของคุณเสียบอยู่มีไฟ
- รีบูตเราเตอร์ของคุณ
- ติดต่อ ISP ของคุณและสอบถามเกี่ยวกับปัญหาการใช้งานได้ในพื้นที่ของคุณ

วิธีการที่ใช้กันโดยทั่วไปเมื่อต้องการแก้ปัญหาเราเตอร์ของคุณคือ การปิดและเปิดใหม่อีกครั้ง เราเตอร์ของคุณสามารถโหลดการตั้งค่าที่กำหนดเองอีกครั้ง และอุปกรณ์อื่นๆ (เช่นโมเด็ม) จะสามารถค้นพบเราเตอร์และสื่อสารกันได้ กระบวนการนี้เรียกว่าการรีบูต

เมื่อต้องการรีบูตเราเตอร์ของคุณโดยใช้สายไฟ ให้ทำดังนี้:

1. ถอดสายไฟออกจากเราเตอร์และโมเด็ม
2. รอประมาณ 10 วินาที แล้วต่อสายไฟเข้ากับโมเด็ม ตรวจสอบให้แน่ใจว่ามีไฟ
3. รอจนกว่าไฟแสดงสถานะการออนไลน์ของโมเด็มจะหยุดกะพริบ (ประมาณสองนาาที) เชื่อมต่อสายไฟเข้ากับเราเตอร์อีกครั้ง
4. รอจนกว่าโลโก้ของ Linksys จะติดสว่างขึ้น รอประมาณสองนาาทีก่อนพยายามเชื่อมต่อกับอินเทอร์เน็ตจากคอมพิวเตอร์

เมื่อต้องการรีบูตเราเตอร์ของคุณโดยใช้ Linksys Smart Wi-Fi ให้ทำดังนี้:

1. เข้าสู่ระบบ Linksys Smart Wi-Fi (ดู "วิธีการเชื่อมต่อกับ Linksys Smart Wi-Fi" ในหน้า [11](#))
2. ใน *Router Settings (การตั้งค่าเราเตอร์)* ให้คลิก *Troubleshooting (การแก้ไขปัญหา)*
3. คลิกแท็บ *Diagnostics (การวินิจฉัย)*
4. ใน *Reboot (รีบูต)* คลิก **Reboot (รีบูต)**



5. คลิก Yes (ใช่) เราเตอร์จะรีบูต ในขณะที่เราเตอร์กำลังรีบูต อุปกรณ์ที่เชื่อมต่อทั้งหมดจะสูญเสียการเชื่อมต่ออินเทอร์เน็ต และจะเชื่อมต่ออีกครั้งโดยอัตโนมัติเมื่อเราเตอร์พร้อมทำงานอีกครั้ง

### Linksys Smart Wi-Fi ไม่เปิดในเว็บเบราว์เซอร์ของคุณ

เวอร์ชันล่าสุดของ Google Chrome™, Firefox®, Safari® (สำหรับ Mac® และ iPad®), Microsoft Edge และ Internet Explorer® เวอร์ชัน 8 และใหม่กว่าจะทำงานร่วมกับ Linksys Smart Wi-Fi ได้

# คุณสมบัติเฉพาะ

## Linksys EA8300

ชื่อรุ่น	Max-Stream AC2200 MU-MIMO Tri-Band Router
หมายเลขรุ่น	EA8300
ความเร็วพอร์ตสวิตช์	10/100/1000 Mbps (Gigabit Ethernet)
ความถี่คลื่นวิทยุ	2.4 GHz และ 5 GHz (x2)
จำนวนของเสาอากาศ	เสาอากาศภายนอกปรับได้ 4 เสา (ไม่สามารถถอดออกได้)
พอร์ต	USB 3.0, อีเทอร์เน็ต (1-4), อินเทอร์เน็ต, เปิด/ปิด
ปุ่ม	Wi-Fi Protected Setup, เปิด/ปิด, รีเซ็ต
ไฟ	แผงควบคุมบน: โลโก้ Linksys ที่ไฟติดสว่าง, Wi-Fi Protected Setup, การเชื่อมต่ออินเทอร์เน็ต, การเชื่อมต่อด้วยสายเคเบิลเครือข่ายเข้ากับพอร์ตอินเทอร์เน็ต แผงด้านหลัง: USB, อีเทอร์เน็ต (1-4), อินเทอร์เน็ต
UPnP	สนับสนุน
คุณสมบัติในการรักษาความปลอดภัย	WEP, WPA2, RADIUS
จำนวนบิตของคีย์การรักษาความปลอดภัย	เข้ารหัสข้อมูลที่ระดับสูงถึง 128 บิต
Storage File System Support (การสนับสนุนระบบไฟล์ที่จัดเก็บ)	FAT, NTFS และ HFS+
รองรับเบราว์เซอร์	เวอร์ชันล่าสุดของ Google Chrome™, Firefox®, Safari® (สำหรับ Mac® และ iPad®), Microsoft Edge และ Internet Explorer® version 8 และใหม่กว่า

## คุณสมบัติภายนอก

ขนาด	213.7 มม. x 161.8 มม. x 54.8 มม. (ไม่รวมเสาอากาศ)
น้ำหนักเครื่อง	608 ก.
กำลัง	12V, 2A
การรับรองมาตรฐาน	FCC, IC, CE, Wi-Fi (a/b/g/n/ac)
อุณหภูมิในการใช้งาน	32 ถึง 104°F (0 ถึง 40°C)
อุณหภูมิในการจัดเก็บ	-4 ถึง 140°F (-20 ถึง 60°C)
ความชื้นที่เหมาะสมในการใช้งาน	ความชื้นสัมพัทธ์ 10% ถึง 80% ,ไม่มีการควบแน่น
ความชื้นที่เหมาะสมในการจัดเก็บ	5% ถึง 90% ไม่มีการควบแน่น

คุณสมบัติเฉพาะอาจเปลี่ยนแปลงได้โดยไม่ต้องแจ้งให้ทราบล่วงหน้า

หมายเหตุ:

สำหรับข้อบังคับ การรับประกัน และข้อมูลความปลอดภัย โปรดดูในแผ่นซีดีที่มาพร้อมกับเราเตอร์ของคุณ หรือไปที่ [Linksys.com/support/EA8300](http://Linksys.com/support/EA8300)

ประสิทธิภาพสูงสุดตามมาตรฐาน IEEE Standard 802.11 ประสิทธิภาพการทำงานจริงอาจแตกต่างกันไป เช่น การรองรับการใช้งานเครือข่ายไร้สาย อัตราการรับส่งข้อมูล ระยะและการครอบคลุมการใช้งานอาจต่ำกว่าที่ระบุไว้ ประสิทธิภาพการทำงานจะขึ้นอยู่กับหลายปัจจัย สภาพแวดล้อมการทำงาน และตัวแปรอื่นๆ รวมถึงระยะห่างจากจุดเชื่อมต่อ ปริมาณการรับส่งข้อมูลเครือข่าย โครงสร้างและส่วนประกอบของอาคาร ระบบปฏิบัติการที่ใช้ การใช้ผลิตภัณฑ์ไร้สายจากผู้ผลิตหลายราย สัญญาณรบกวน และสภาพแวดล้อมอื่นๆ ที่อาจส่งผลกระทบต่อการทำงาน

BELKIN, LINKSYS รวมถึงชื่อและโลโก้ของผลิตภัณฑ์ต่างๆ เป็นเครื่องหมายการค้าของบริษัทในเครือ Belkin เครื่องหมายการค้าของบุคคลที่สามที่ระบุไว้เป็นกรรมสิทธิ์ของผู้เป็นเจ้าของแต่ละราย สามารถอ่านลิขสิทธิ์และประกาศเกี่ยวกับซอฟต์แวร์ของบุคคลที่สามในผลิตภัณฑ์นี้ได้ที่นี่: <http://support.linksys.com/en-us/license> โปรดติดต่อ <http://support.linksys.com/en-us/gplcodecenter> หากมีคำถามหรือต้องการร้องขอซอร์สโค้ด GPL

© 2017 Belkin International, Inc. และ/หรือบริษัทในเครือ สงวนลิขสิทธิ์

**LINKSYS®**

Kullanıcı Kılavuzu

**MAX-STREAM™**  
**AC2200 MU-MIMO**  
**ÜÇ BANTLI YÖNLENDİRİCİ**

Model EA8300

# İçindekiler

Ürüne Genel Bakış .....	3
Üstten görünüm .....	3
Sistem durumu göstergesi.....	4
Arkadan görünüm .....	5
Yandan görünüm.....	6
Kurulum: Genel Bilgiler .....	7
Daha fazla yardım bulma.....	7
Router'ınızın kurulması.....	8
Linksys Smart Wi-Fi Kullanımı .....	11
Linksys Smart Wi-Fi bağlantısının yapılması.....	11
Ağ Haritası .....	12
Konuk Erişimi .....	12
Ebeveyn Denetimleri .....	13
Ortam Önceliklendirme.....	13
Speed Test.....	14
Harici Depolama.....	14
Bağlantı.....	15
Sorun Giderme.....	15
Kablosuz .....	16
Güvenlik .....	16
Sorun Giderme .....	17
Router'ınız başarıyla kurulamadı .....	17
<i>Your Internet cable is not plugged (İnternet kablonuz takılı değil)</i> mesajı.....	18
<i>Cannot access your router (Router'ınıza erişilemiyor)</i> mesajı.....	19
Kurulum sonrası .....	21
İnternet kullanılamıyor .....	21
Linksys Smart Wi-Fi web tarayıcınızda açılmıyor .....	22
Spesifikasyonlar .....	23
Linksys EA8300 .....	23
Çevresel.....	23

# Ürüne Genel Bakış

## Üstten görünüm

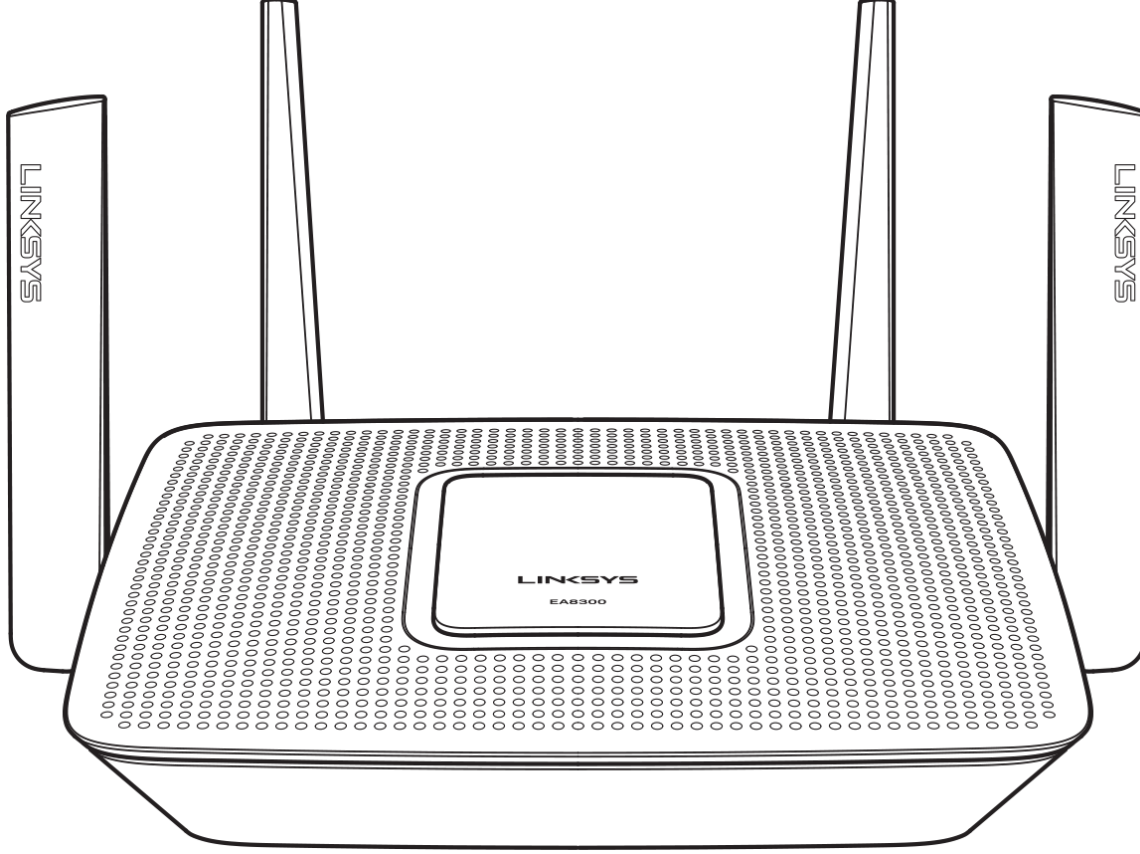

## Sistem durumu göstergesi

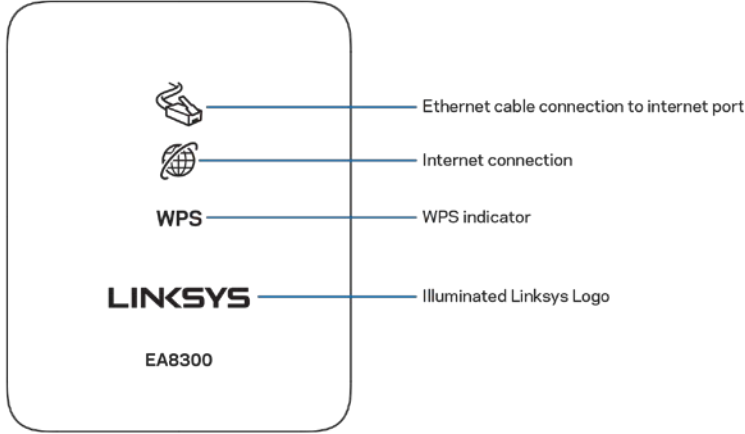

Ethernet kablosu ve İnternet bağlantı noktası bağlantısı (1) Yandığında (turuncu) ağ kablosu ve İnternet (WAN) bağlantı noktası bağlantısında bir sorun olduğunu gösterir.

İnternet bağlantısı (2) Yandığında (turuncu) yönlendiricinin internete erişimi olmadığını gösterir.

WPS (Wi-Fi Korumalı Kurulum™) göstergesi — WPS ışığı dört durumu gösterir:

<b>Kapalı</b>	Wi-Fi Korumalı Kurulum etkinliği yok
<b>Beyaz Yanıp Sönen</b>	Wi-Fi Korumalı Kurulum sürüyor
<b>Sürekli Beyaz</b>	Wi-Fi Korumalı Kurulum başarılı olduğunda beş saniye boyunca yanar
<b>Turuncu Yanıp Söner</b>	Wi-Fi Korumalı Kurulum hatası olduğunda bir dakika boyunca yanıp söner ve kapanır

Işıklı Linksys Logosu: Logo yönlendirici başlatılırken yanıp söner. Logo sürekli beyaz yandığında yönlendirici doğru şekilde açılmış ve çalışıyor demektir.

## Arkadan görünüm

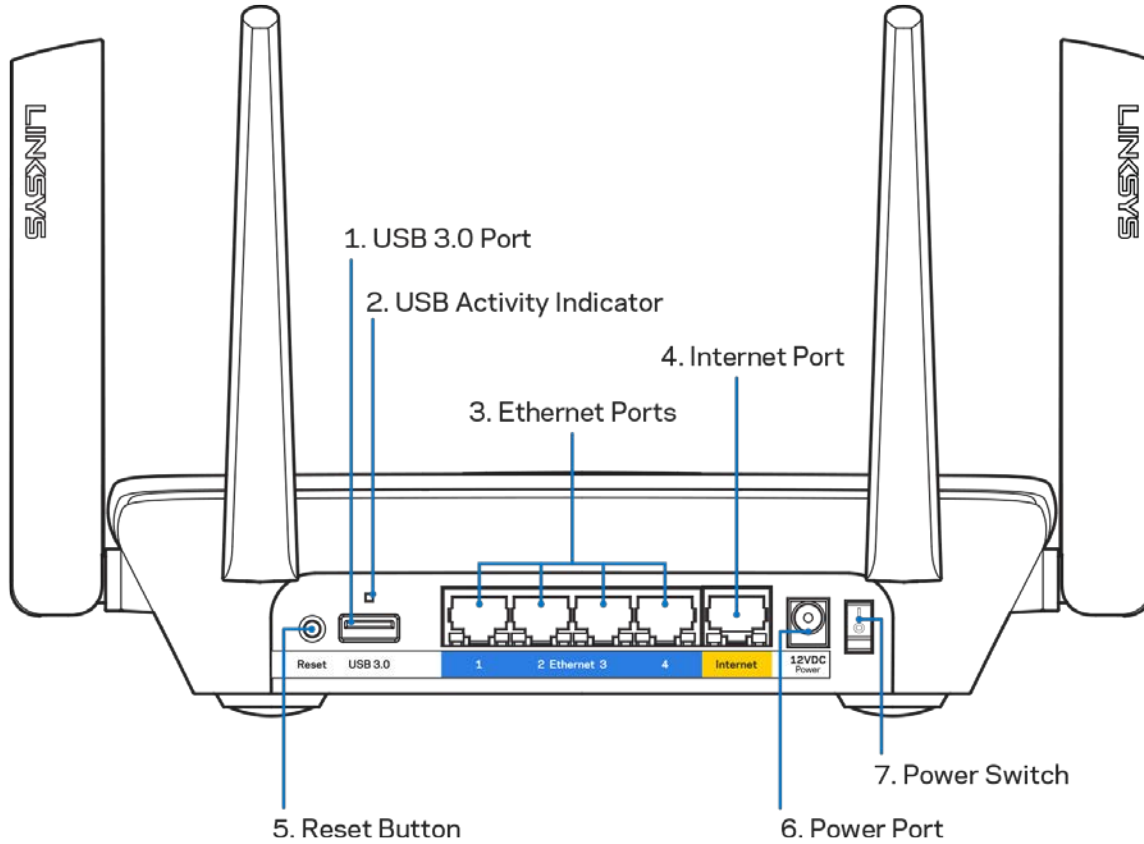

**USB 3.0 bağlantı noktası (1)** Ağınızdaki veya internetteki USB sürücülerine bağlanın ve paylaşın.

**USB etkinlik göstergesi (2)** Işıklar dış cihazlardan veri aktarımını gösterir.

Ethernet bağlantı noktaları (3) Ethernet kablosunu bu mavi gigabit (10/100/1000) bağlantı noktalarına ve ağınızdaki kablolu cihazlara bağlayın.

**Not**—En iyi performans için, Ethernet bağlantı noktalarında, CAT5e veya daha üst sınıftan kablolar kullanın.

**İnternet bağlantı noktası (4)** Ethernet kablosunu bu sarı gigabit (10/100/1000) bağlantı noktasına ve geniş bantlı internet kablosuna/DSL fiber modeme bağlayın.

**Not**—En iyi performans için, İnternet bağlantı noktasında, CAT5e veya daha üst sınıf kablo kullanın.

**Sıfırla düğmesi (5)** Yönlendiriciyi fabrika ayarlarına sıfırlamak için Linksys logosunun ışığı sönene kadar basılı tutun. Ayrıca internetten veya mobil uygulamalar üzerinden Linksys Smart Wi-Fi kullanarak fabrika ayarlarını geri yükleyebilirsiniz.

**Güç bağlantı noktası (6)**—Pakete dahil olan AC güç bağdaştırıcısını takın.

**Güç anahtarı (7)**—Router'ı açmak için | (on - açık) düğmesine basın.



## Yandan görünüm

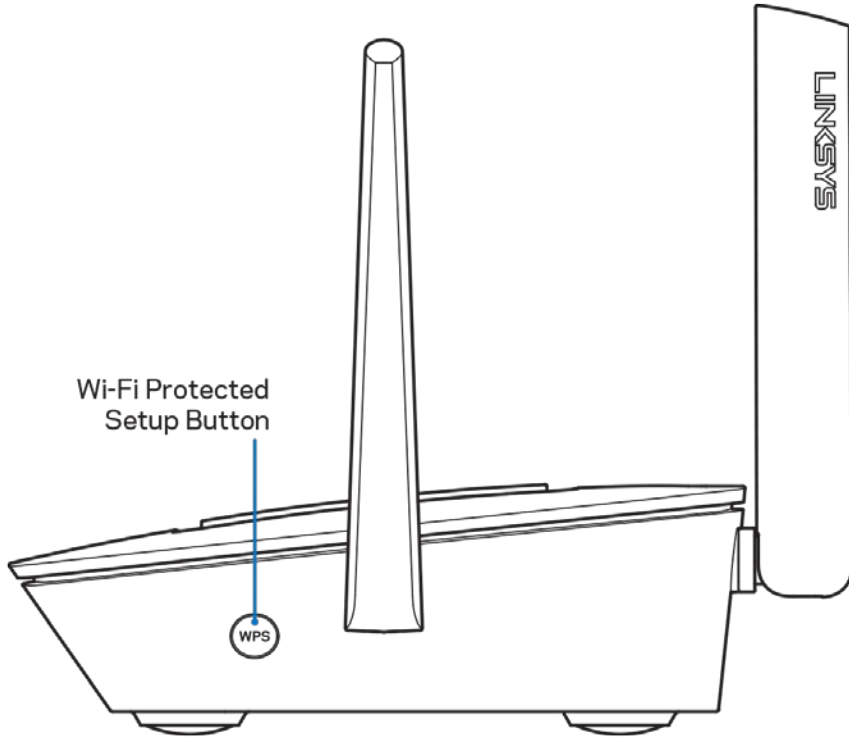

**Wi-Fi Korunmalı Kurulum™ düğmesi:** WPS'in etkinleştirildiği ağ cihazlarına bağlanmak için basın.

# Kurulum: Genel Bilgiler

## Daha fazla yardım bulma

Bu kullanıcı kılavuzuna ek olarak aşağıdaki adreslerden yardım alabilirsiniz:

- [Linksys.com/support/EA8300](http://Linksys.com/support/EA8300) (belgeler, indirilenler, SSS, teknik destek, canlı sohbet, forumlar)
- Linksys Smart Wi-Fi yardım (Linksys Smart Wi-Fi'a bağlanın, sonra ekranın üstündeki Yardım yazısına tıklayın)

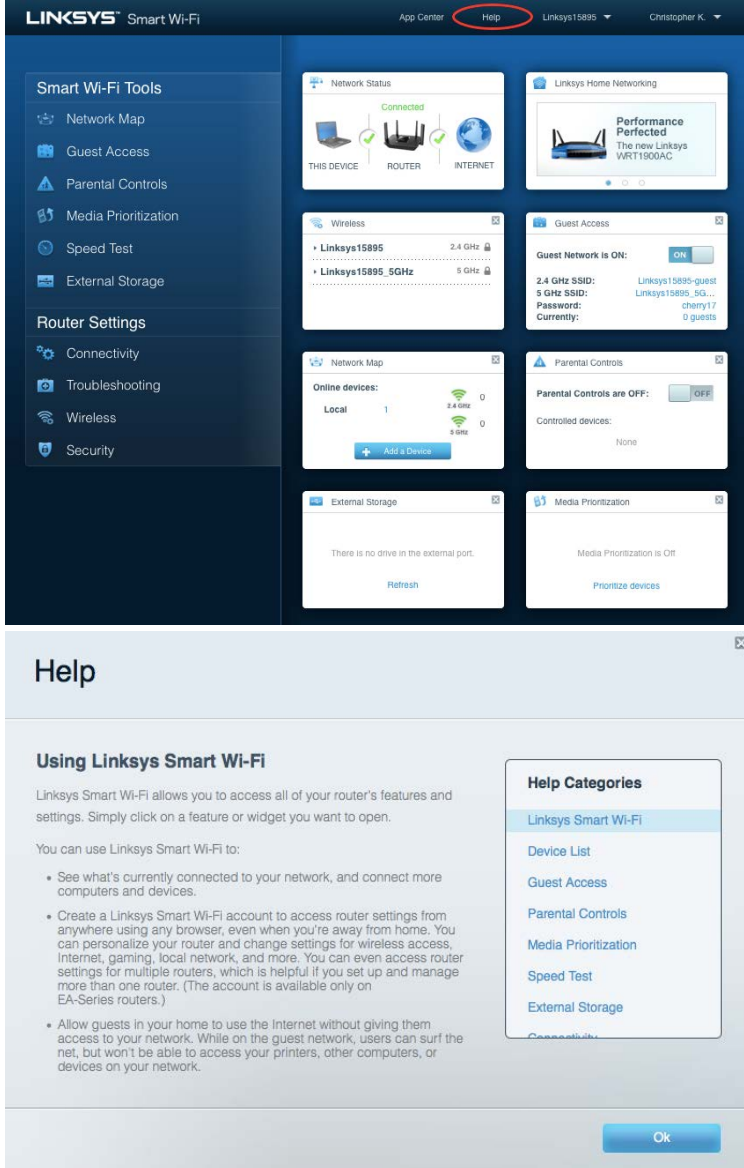

The screenshot shows the Linksys Smart Wi-Fi app interface. At the top, there is a navigation bar with 'App Center', 'Help' (highlighted with a red circle), 'Linksys15895', and 'Christopher K.'. The main screen is divided into two sections: 'Smart Wi-Fi Tools' and 'Router Settings'. The 'Smart Wi-Fi Tools' section includes 'Network Map', 'Guest Access', 'Parental Controls', 'Media Prioritization', 'Speed Test', and 'External Storage'. The 'Router Settings' section includes 'Connectivity', 'Troubleshooting', 'Wireless', and 'Security'. Below these sections, there are several widgets: 'Network Status' (showing 'Connected'), 'Linksys Home Networking' (showing 'Performance Perfected'), 'Wireless' (showing 'Linksys15895' and 'Linksys15895\_5GHz'), 'Guest Access' (showing 'Guest Network is ON'), 'Network Map' (showing 'Online devices'), 'Parental Controls' (showing 'Parental Controls are OFF'), 'External Storage' (showing 'There is no drive in the external port'), and 'Media Prioritization' (showing 'Media Prioritization is Off').

The 'Help' menu is open, showing the following content:

### Using Linksys Smart Wi-Fi

Linksys Smart Wi-Fi allows you to access all of your router's features and settings. Simply click on a feature or widget you want to open.

You can use Linksys Smart Wi-Fi to:

- See what's currently connected to your network, and connect more computers and devices.
- Create a Linksys Smart Wi-Fi account to access router settings from anywhere using any browser, even when you're away from home. You can personalize your router and change settings for wireless access, Internet, gaming, local network, and more. You can even access router settings for multiple routers, which is helpful if you set up and manage more than one router. (The account is available only on EA-Series routers.)
- Allow guests in your home to use the Internet without giving them access to your network. While on the guest network, users can surf the net, but won't be able to access your printers, other computers, or devices on your network.

### Help Categories

- Linksys Smart Wi-Fi
- Device List
- Guest Access
- Parental Controls
- Media Prioritization
- Speed Test
- External Storage
- Connectivity

Ok

**Not—Üçüncü şahıs yazılımlarıyla ilgili lisans ve uyarılar <http://support.linksys.com/en-us/license> adresinde görüntülenebilir. Sorularınız veya GPL kaynak kodu istekleriniz için <http://support.linksys.com/en-us/gplcodecenter> adresi üzerinden bizimle iletişime geçiniz.**

## Router'ınızın kurulması

1. Kurulumu tamamlamak için web tarayıcısında <http://LinksysSmartWiFi.com> adresini ziyaret edeceğiniz bir bilgisayara ihtiyacınız olur.
2. Ekipmanınızı tanımlayın.

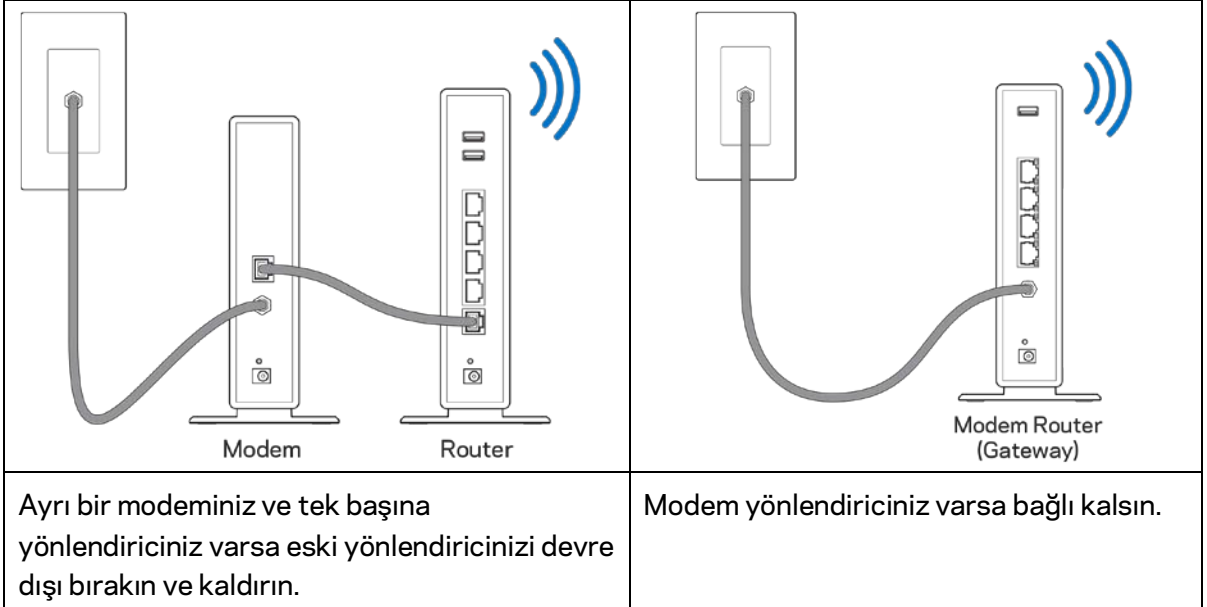

3. Antenleri dik bir şekilde konumlandırın ve router'ı bir güç kaynağına takın. Güç anahtarının | (açık) konumunda olduğundan emin olun.
4. Router'ınızı modeminize veya modem router'ınıza bağlayın. Pakete dahil edilen internet kablosunun bir ucunu yeni router'ınızdaki sarı internet bağlantı noktasına takın. Modeminiz varsa diğer ucu modemdeki Ethernet (LAN) bağlantı noktasına takın. Modem yönlendiriciniz varsa herhangi bir bağlantı noktasına takın.
5. Yönlendiricinizin üst kısmındaki yanıp sönme ışığı yanıp sönmeyi bırakana ve sürekli beyaz yanana kadar bekleyin.
6. Router'ınızla birlikte gelen Hızlı Başlangıç Kılavuzu'nda belirtilen Wi-Fi adına bağlanın. (Bu detayları daha sonra değiştirebilirsiniz.) Ağa bağlanma konusunda yardıma ihtiyac duyarsanız [linksys.com/support/EA8300](http://linksys.com/support/EA8300) adresindeki cihaz belgelerine bakın.

**Not**—Router kurulumu tamamlanana kadar internet erişiminiz olmayacaktır.

7. Web tarayıcısına <http://LinksysSmartWiFi.com> adresini girin. Router'ınızın kurulumunu tamamlamak için ekrandaki yönergeleri takip edin. Kurulumu başlatmak için bir tarayıcıya 192.168.1.1 de yazabilirsiniz.

Kurulum sona erdiğinde ekrandaki talimatları izleyerek Linksys Smart Wi-Fi hesabınızı kurun. Router'ınızı internet bağlantısı olan herhangi bir bilgisayardan yapılandırmak için Linksys Smart Wi-Fi kullanın.

Router'ınızın ayarlarını yönetin:

- Router adını ve parolasını deęiřtirin
- Konuk erişimini ayarlayın
- Ebeveyn denetimlerini yapılandırın
- Cihazları Wi-Fi'ınıza baęlayın
- İnternet baęlantı hızınızı test edin

**Not:** *Linksys Smart Wi-Fi hesabı kurulumunun bir parçası olarak size bir doęrulama e-postası gönderilir. Router'ınızı Linksys Smart Wi-Fi hesabınızla ilişkilendirmek için ev aęınızdan e-postadaki baęlantıya tıklayın.*

**İpucu:** *Bir sonraki sayfayı yazdırıp tablodaki yönlendirici ve hesap ayarlarınızı referans olarak kaydedin. Notlarınızı güvenli bir yerde saklayın.*

2.4 GHz Wi-Fi Adı	
Wi-Fi Şifresi	
5 GHz <sub>1</sub> Wi-Fi Adı	
Wi-Fi Şifresi	
5 GHz <sub>2</sub> Wi-Fi Adı	
Wi-Fi Şifresi	
Router Parolası	
2.4 GHz'lik Konuk Wi-Fi Adı	
5GHz'lik Konuk Wi-Fi Adı	
Konuk Wi-Fi Parolası (Her ikisi de bir parolayı paylaşır.)	
Linksys Smart Wi-Fi Kullanıcı Adı	
Linksys Smart Wi-Fi Parolası	

# Linksys Smart Wi-Fi Kullanımı

Linksys Smart Wi-Fi'ı kullanarak yönlendiricinizi dünyanın her yerinden yönetebilirsiniz ancak doğrudan ev ağınızdan da bunu yapabilirsiniz. Linksys Smart Wi-Fi mobil aygıtınızda da kullanılabilir. Bilgi için aygıtınızın uygulama mağazasına bakın.

## Linksys Smart Wi-Fi bağlantısının yapılması

Linksys Smart Wi-Fi bağlantısının yapılması:

1. Bilgisayarınızın web tarayıcısını açın.
2. <http://LinksysSmartWiFi.com> adresine gidin ve hesabınızda oturum açın.

Linksys Smart Wi-Fi Sign In

If you have not yet created a Linksys Smart Wi-Fi account, click the "Create Account" button in the upper right corner of the page.

Give guests Internet access

Use your Linksys Smart Wi-Fi account to access your home network from anywhere, at any time, even from your mobile device. Easily connect new devices, set parental controls, get access to Smart Wi-Fi mobile Apps, and more.

For more information [click here](#)

Sign In

Don't have an account? [Click here.](#)

English (United States)

For local access, [click here.](#)

Parolanızı hatırlamıyorsanız *Forgot your password?* (*Parolanızı mı unuttunuz?*) seçeneğine tıklayın ve geri almak için ekrandaki talimatları izleyin.

## Ağ Haritası

Router'ınıza bağlı tüm ağ aygıtlarını görüntülemenizi ve yönetmenizi sağlar. Ana ağınızdaki ve konuk ağınızdaki aygıtları görüntüleyebilir veya her bir aygıtlarla ilgili bilgileri görüntüleyebilirsiniz.



## Konuk Erişimi

Konukların kişisel bilgilerinize ulaşmadan Wi-Fi'a erişmesi için bir ağ kurmanıza ve bu ağı izlemenize olanak tanır.

The Guest Access configuration interface includes the following sections:

- Allow guest access:** A toggle switch is currently turned ON.
- Guest network names and password:** A table showing settings for 2.4 GHz and 5 GHz networks.
- Total guests allowed:** A dropdown menu set to "5 guests".

A warning message states: "Your guest should first connect to your guest network, open a web browser, and then enter the guest password." The interface also features "OK" and "Cancel" buttons at the bottom.

Band	SSID	Network
2.4 GHz	parlor2.4	Enabled
5 GHz	parlor5	Enabled

Guest network password: thefly

## Ebeveyn Denetimleri

Web sitelerini engelleme ve internet erişim zamanları belirleme işlemlerini sağlar.

### Parental Controls

Limit when your children get online and what websites they can see.

Show widget on the homepage

**Enable parental controls**

OFF

**Restrict Internet access on**

- Christopher's MacBook Air
- CMK's Galaxy S5
- ChristohersIPad
- ODK's Kindle Fire**
- ODKs-iPod
- TTKs-iPad

**Block Internet access**

Never  
 Always  
 Specific Times

**Block specific sites**

www.blockedsite.com Enter a website to block

Ok Cancel

## Ortam Önceliklendirme

Ağ trafiğinizde hangi aygıt ve uygulamaların önceliğe sahip olduğunu belirleme işlemlerini sağlar.

### Media Prioritization

Give priority to those devices, applications, and games that connect to streaming or real-time media services for best performance on your home network.

Show widget on the homepage

**Prioritization:**  ON [Reset Prioritization](#) | [Settings](#)

**High Priority**

Drag and drop devices to prioritize

**Normal Priority**

**Devices**

- Christopher's MacB...
- CMK's Galaxy S5
- ChristohersIPad
- ODK's Kindle Fire
- ODKs-iPod
- TTKs-iPad

**Applications** Edit | Delete

Skype

**Online Games** Edit | Delete

City of Heroes / Villians

Ok Cancel



## Speed Test

Ağınızın internet bağlantısı hızını test etmenizi sağlar.



## Harici Depolama

Bağlı bir USB sürücüyü (pakete dahil değildir) erişimimize ve dosya paylaşımı, ortam sunucusu ve FTP erişimi kurmanıza olanak tanır.

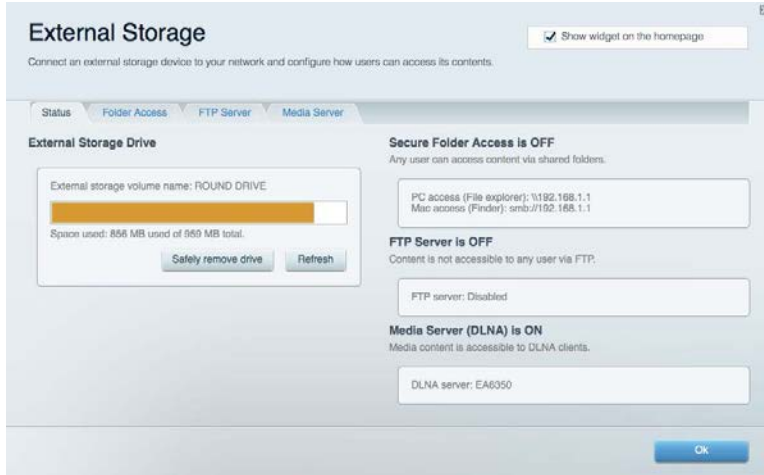

## Bağlantı

Temel ve gelişmiş ağ ayarlarını görüntülemenize ve değiştirmenize olanak tanır.

### Connectivity

View and change router settings

Basic Internet Settings Local Network Advanced Routing VLAN Administration

**Network Name and Password** | Edit

2.4 GHz network name: arachnid  
Network password: peterparkier

5 GHz<sub>1</sub> + 5 GHz<sub>2</sub> network name: arachnid\_5GHz  
Network password: peterparkier

**Router Password** | Edit

Router password: \*\*\*\*\*

**Router Firmware Update**

Automatic (Current Version: 1.1.5.164615)  
[Check for Updates](#)

**Time Zone**

(GMT-05:00) Eastern Time (USA & Canada) ▾  
 Automatically adjust for Daylight Savings Time

**Activity Lights**

ON Enable/disable activity lights. Power light will remain on.

[Ok](#) [Cancel](#) [Apply](#)

## Sorun Giderme

Router'ınızla ilgili sorunları tanımlamanızı ve ağınızın durumunu kontrol etmenizi sağlar.

### Troubleshooting

Troubleshoot router settings

Status Diagnostics Logs

**Ping IPv4**

IP or host name:   
Number to ping: 5 ▾  
[Start to Ping](#)

**Trace route**

IP or host name:   
[Start to Traceroute](#)

**Reboot**

[Reboot the router](#)

**Router configuration**

[Backup](#) [Restore](#)

**Router Firmware**

[Restore previous firmware](#)

**Internet Address:**

IPv4: 10.0.0.253 [Release and Renew](#)  
IPv6: 2601:0540::000:0019:0000:0000:0000:314e [Release and Renew](#)

**Factory reset**

[Reset to factory default settings](#)

[Ok](#)

## Kablosuz

Yönlendiricinizin kablosuz ağını görüntülemenize ve değiştirmenize olanak tanır. Wi-Fi Korumalı Kurulumunu kullanarak ağ adlarını, güvenlik modunu, parolayı, MAC filtrelemesini değiştirebilirsiniz ve cihazlara bağlanabilirsiniz.

### Wireless

View and change router settings

Wireless MAC Filtering Wi-Fi Protected Setup

Smart Connect:  5 GHz band steering  Off  
5 GHz<sub>1</sub> + 5 GHz<sub>2</sub> Individual networks What is Smart Connect band steering?

Network name:  2.4 GHz Network:  ON

Password:  Broadcast SSID:  Channel:

Security mode:  Network mode:  Channel width:

Network name:  5 GHz<sub>1</sub> + 5 GHz<sub>2</sub> Network:  ON

Password:  Broadcast SSID:  Channel:

Security mode:  Network mode:  Channel width:

Ok Cancel Apply

## Güvenlik

Yönlendiricinizin kablosuz güvenliğini görüntülemenize ve değiştirmenize olanak tanır. Güvenlik duvarını ayarlayabilir, VPN ayarlarını yapabilir ve uygulamalar ve oyunlar için özel ayarlar belirleyebilirsiniz.

### Security

View and change router settings

Firewall DMZ Apps and Gaming

#### Firewall

IPv4 SPI firewall protection  Enabled

IPv6 SPI firewall protection  Enabled

#### VPN Passthrough

IPSec Passthrough  Enabled

PPTP Passthrough  Enabled

L2TP Passthrough  Enabled

#### IPv6 Port Services

Description	Protocol	IPv6 Address	Allow	Enabled

Add IPv6 Firewall Setting

#### Internet filters

Filter anonymous Internet requests

Filter multicast

Filter Internet NAT redirection

Filter ident (Port 113)

Ok Cancel Apply

# Sorun Giderme

[linksys.com/support/EA8300](https://linksys.com/support/EA8300) adresinde ödüllü müşteri desteğimizden daha fazla yardım alabilirsiniz.

## Router'ınız başarıyla kurulamadı

Linksys Smart Wi-Fi kurulumu tamamlamadıysa şunları deneyebilirsiniz:

- Işıklı Linksys logosu sönene ve mavi MU-MIMO göstergeleri yanıp sönmeye başlayana kadar (yaklaşık 10 saniye) bir ataş veya toplu iğne yardımıyla router'ınızın üzerindeki Sıfırla düğmesine basılı tutun. Router'ı yeniden yükleyin.

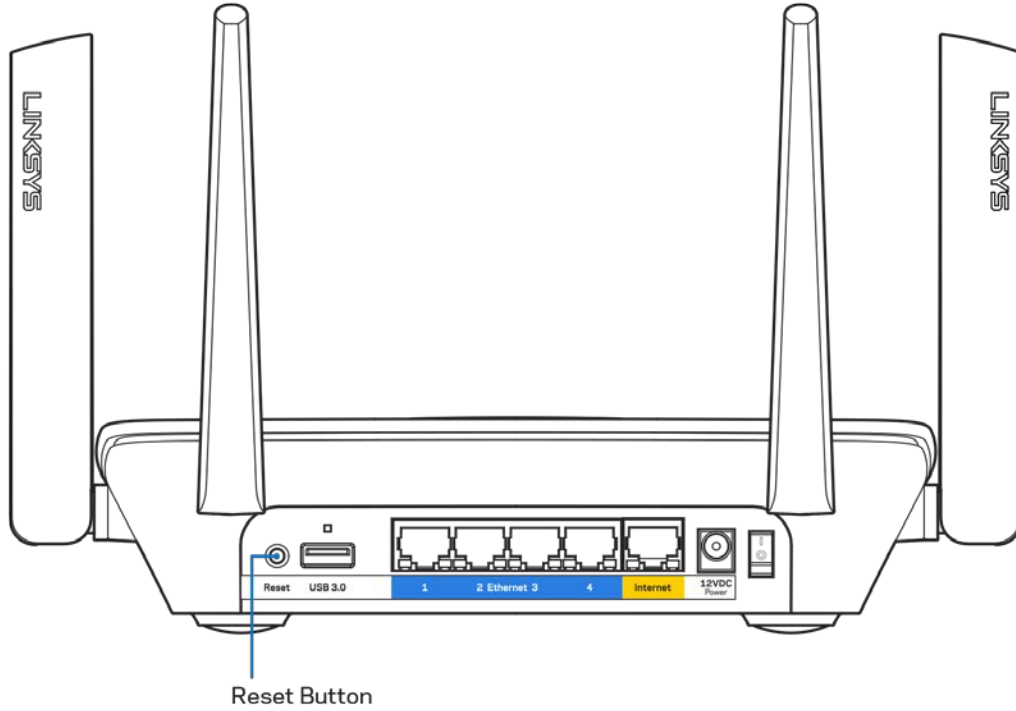

- Bilgisayarınızın güvenlik duvarını geçici olarak devre dışı bırakın (yardım için güvenlik yazılımının talimatlarına bakın). Router'ı yeniden yükleyin.
- Başka bir bilgisayarınız varsa, router'ı yeniden yüklemek için o bilgisayarı kullanın.

## *Your Internet cable is not plugged (İnternet kablonuz takılı değil) mesajı*

Router'ınızı kurmaya çalışırken "Your Internet cable is not plugged in" (İnternet kablonuz takılı değil) mesajı alırsanız bu sorun giderme adımlarını uygulayın.

- Ethernet veya internet kablosunun (yönlendiriciniz ile verilen gibi bir kablo) yönlendiricinin arka kısmındaki sarı İnternet bağlantı noktasına ve modemizdeki uygun bağlantı noktasına sabit bir şekilde bağlı olduğundan emin olun. Modemdeki bu bağlantı noktası genellikle Ethernet etiketlidir.

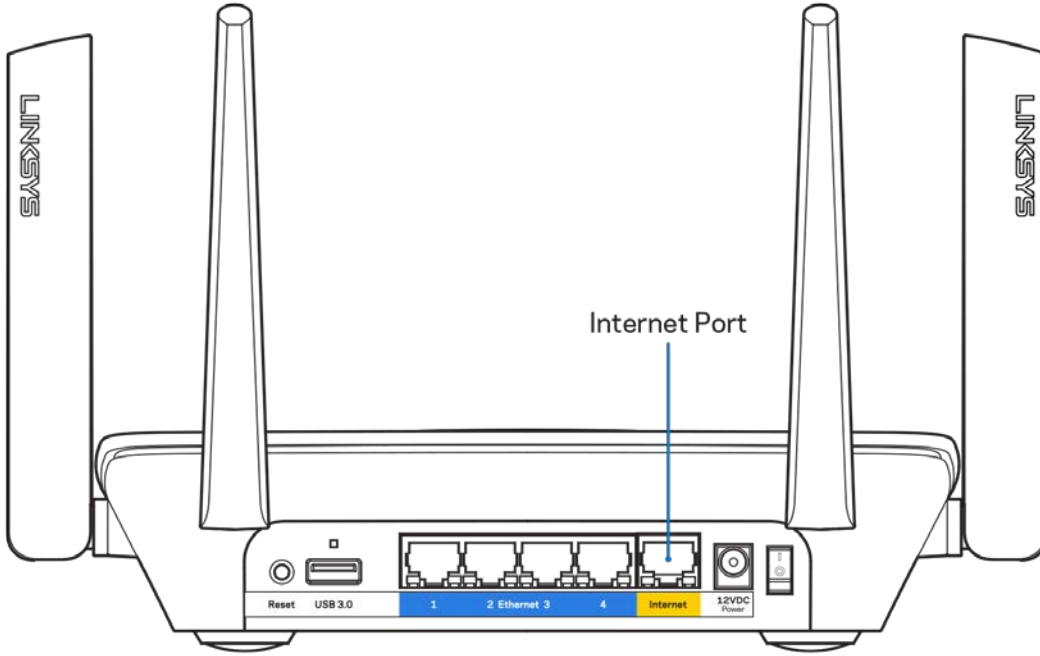

- Modemin fişinin takılı ve açık olduğundan emin olun. Güç düğmesi varsa, ON (AÇIK) veya | (O'nun karşı tarafında) konumunda olduğundan emin olun.

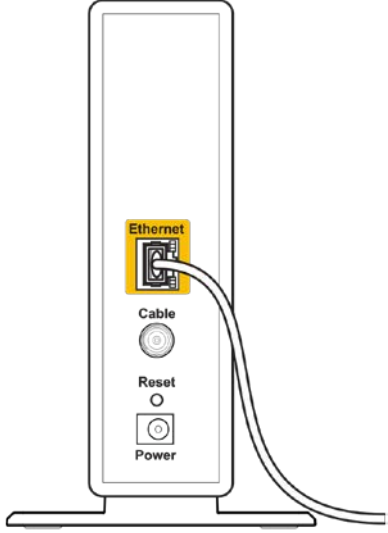
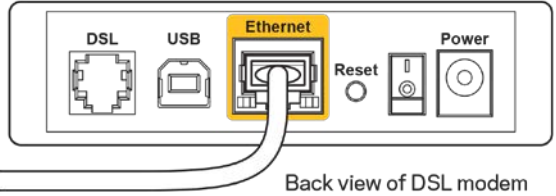
 <p>Back view of cable modem</p>	 <p>Back view of DSL modem</p>
<p>İnternet hizmetiniz kablolu internet ise, kablolu modemin CABLE (KABLO) bağlantı noktasının, İSS'niz (İnternet Servis Sağlayıcı) tarafından sağlanan koaksiyel kabloya bağlı olduğundan emin olun.</p>	<p>İnternet hizmetiniz DSL ise, DSL telefon hattının, modemin DSL bağlantı noktasına bağlı olduğundan emin olun.</p>

- Bilgisayarınız modeminize daha önce USB kablosuyla bağlanmışsa USB kablosunu çıkarın.
- Router'ı yeniden yükleyin.

## ***Cannot access your router (Router'ınıza erişilemiyor) mesajı***

Router'ınıza erişmek için kendi ağınıza bağlı olmanız gerekir. Kablosuz internet erişimine sahipseniz sorun yanlışlıkla farklı bir kablosuz ağa bağlanmanız olabilir.

Windows yüklü bilgisayarlarda sorunu çözmek için aşağıdakileri yapın\*:

1. Sistem tepsisindeki kablosuz simgeye tıklayın. Kullanılabilir ağların listesi görüntülenecektir.

2. Ağınızın adına tıklayın. Connect'e (Bağlan) tıklayın. Aşağıdaki örnekte, bilgisayar, wraith\_5GHz adındaki başka bir kablosuz ağa bağlanmıştır. Bu örnekte Linksys EA8300 yönlendiricinin kablosuz ağ adı, Damaged\_Beez2.4 seçili olarak gösterilir.



3. Ağ güvenlik anahtarını girmeniz istenirse parolanızı (güvenlik anahtarı) ağ güvenlik anahtarı alanına girin. OK (Tamam) ögesine tıklayın.
4. Bilgisayarınız ağa bağlanacaktır, artık router'a erişebilir durumda olmanız gerekir.

*\*Windows sürümünüze bağlı olarak bu adımlardaki ifadelerde veya simgelerde bazı farklılıklar olabilir.*

Mac bilgisayarlarda sorunu çözmek için aşağıdakileri yapın:

1. Ekranın en üstünde yer alan menü çubuğunda Wi-Fi simgesine tıklayın. Kablosuz ağların listesi görüntülenecektir.
2. Aşağıdaki örnekte, bilgisayar, wraith\_5GHz adındaki başka bir kablosuz ağa bağlanmıştır. Bu örnekte Linksys EA8300 yönlendiricinin kablosuz ağ adı, Damaged\_Beez2.4 seçili olarak gösterilir.



3. Linksys EA8300 yönlendiricinizin kablosuz ağ adına (bu örnekte Damaged\_Beez2.4) tıklayın.
4. Kablosuz ağ parolanızı (Güvenlik Anahtarı) *Password (Parola)* alanına girin. OK (**Tamam**) ögesine tıklayın.

## Kurulum sonrası

### İnternet kullanılmıyor

İnternet, yönlendiricinize bağlanmada sorun yaşıyorsa sorun web tarayıcınızda "[internet adresi] bulunamadı" mesajı olarak görünebilir. İnternet adresinin doğru olduğundan eminseniz ve geçerli internet adreslerini birkaç kez deneyip aynı sonucu aldıysanız mesaj, İSS'nizle (İnternet Servis Sağlayıcısı) veya router'ınızla modem iletişimi sorunu olduğu anlamına gelebilir. Aşağıdakini deneyin:

- Ağ ve güç kablolarının sıkıca bağlandığından emin olun.
- Router'ınızın bağlı olduğu güç çıkışında güç olduğundan emin olun.
- Router'ınızı yeniden yükleyin.
- İSS'nize (İnternet Servis Sağlayıcısı) başvurun ve bulunduğunuz alandaki hizmet kesintilerini sorun.

Router'ınızdaki sorunları gidermenin en yaygın yöntemi kapatıp tekrar açmaktır. Router'ınız böylece özel ayarlarını yeniden yükleyebilir ve (modem gibi) diğer aygıtlar router'ı yeniden keşfedip iletişim kurar. Bu işlem ön yükleme olarak adlandırılır.

Router'ınızı güç kablosunu kullanarak yeniden yüklemek için aşağıdakileri yapın:

1. Güç kablosunu router ve modemden ayırın.
2. 10 saniye bekleyin ve güç kablosunu modeme yeniden takın. Güç gittiğinden emin olun.
3. Modemin çevrim içi göstergesinin yanıp sönmesi durana kadar (veya iki dakika) bekleyin. Güç kablosunu router'a yeniden takın.
4. Işıklı Linksys logosu açılana kadar bekleyin. Bir bilgisayardan İnternet'e bağlanmayı denemeden önce iki dakika bekleyin.

Router'ınızı Linksys Smart Wi-Fi'ı kullanarak yeniden yüklemek için aşağıdakileri yapın:

1. Linksys Smart Wi-Fi'da oturum açın. (Sayfa [11](#) 'teki "Linksys Smart Wi-Fi'a bağlanma" kısmına bakın.)
2. *Router Settings (Router Ayarları)* altında *Troubleshooting (Sorun Giderme)* seçeneğine tıklayın.
3. *Diagnostics (Tanı)* sekmesine tıklayın.
4. *Reboot (Yeniden yükle)* altında Reboot (Yeniden yükle) seçeneğine tıklayın.





5. Yes (Evet) **seçeneğine tıklayın**. Router yeniden yüklenir. Router yeniden yüklenirken tüm bağlı aygıtlar internet bağlantısını kaybeder ve router yeniden hazır olduğunda otomatik olarak tekrar bağlanır.

## Linksys Smart Wi-Fi web tarayıcınızda açılmıyor

Google Chrome™, Firefox®, Safari® (Mac® ve iPad® için), Microsoft Edge'in en son sürümleri ve Internet Explorer® sürüm 8 ve üzeri, Linksys Smart Wi-Fi ile uyumludur.

# Spesifikasyonlar

## Linksys EA8300

Model Adı	Max-Stream AC2200 MU-MIMO Üç Bantlı Yönlendirici
Model Numarası	EA8300
Switch Bağlantı Noktası Hızı	10/100/1000 Mbps (Gigabit Ethernet)
Radyo Frekansı	2.4 GHz ve 5 GHz (x2)
Anten Sayısı	4 adet ayarlanabilir dış anten (çıkarılamaz)
Bağlantı Noktaları	USB 3.0, Ethernet (1-4), İnternet, Güç
Düğmeler	Wi-Fi Korulamalı Kurulum, Güç, Sıfırla
Işıklar	<b>Üst panel:</b> Işıklı Linksys logosu, Wi-Fi Korumalı Kurulum, İnternet bağlantısı, Ağ kablosu ve İnternet bağlantı noktası bağlantısı <b>Arka panel:</b> USB, Ethernet (1-4), İnternet
UPnP	Desteklenen
Güvenlik Özellikleri	WEP, WPA2, RADIUS
Güvenlik Anahtarı Bitleri	128-bit kadar şifreleme
Depolama Dosya Sistem Desteği	FAT, NTFS ve HFS+
Tarayıcı Desteği	Google Chrome™, Firefox®, Safari® (Mac® ve iPad® için), Microsoft Edge ve İnternet Explorer® sürüm 8 ve yenisinin en son sürümleri

## Çevresel

Boyutları	213,7mm x 161,8mm x 54,8mm (antenneler olmadan)
Birim Ağırlığı	608 g
Güç	12V, 2A
Sertifikalar	FCC, IC, CE, Wi-Fi (a/b/g/n/ac)
İşletim Sıcaklığı	0 - 40°C (32 - 104°F)
Depolama Sıcaklığı	-20 - 60°C (-4 - 140°F)
Çalışma Nem Seviyesi	%10 - %80 arası bağıl nem, yoğuşmasız
Depolama Nem Seviyesi	%5 ile %90 arasında yoğuşmasız

Spesifikasyonlar haber verilmeksizin değiştirilebilir.

Notlar:

Düzenlemeler, garanti ve güvenlik ile ilgili bilgiler için yönlendiriciniz ile birlikte gelen CD'ye bakın ya da [Linksys.com/support/EA8300](http://Linksys.com/support/EA8300) adresine gidin.

Maksimum performans IEEE Standard 802.11 spesifikasyonlarından türetilmiştir. Fiili performans, düşük kablosuz ağ kapasitesi, veri aktarım hızı, menzil ve kapsama alanı gibi faktörlere bağlı olarak değişebilir. Performans; erişim noktasına uzaklık, ağ trafiği yoğunluğu, binada kullanılan yapı malzemeleri, kullanılan işletim sistemi, kullanılan kablosuz ürün karması, sinyal karışması ve diğer olumsuz koşullar gibi pek çok faktör, koşul ve değişkene bağlıdır.

BELKIN, LINKSYS ve pek çok ürün adı ve logosu, Belkin şirketler grubunun markasıdır. Üçüncü taraf ticari markaları, kendi sahiplerinin mülkiyetindedir. Üçüncü şahıs yazılımlarıyla ilgili lisans ve uyarılar aşağıdaki adreste görüntülenebilir: <http://support.linksys.com/en-us/license>. Sorularınız veya GPL kaynak kodu istekleriniz için <http://support.linksys.com/en-us/gplcodecenter> adresi üzerinden bizimle iletişime geçiniz.

© 2017 Belkin International, Inc. ve/veya bağlı şirketleri. Her hakkı saklıdır.

**LINKSYS®**

Посібник користувача

**ТРИДІАПАЗОННИЙ  
МАРШРУТИЗАТОР**

**MAX-STREAM™  
AC2200 MU-MIMO**

Модель EA8300

# Зміст

Огляд продукту .....	3
Вигляд зверху .....	3
Індикатор статусу системи .....	4
Вигляд з тильної сторони .....	5
Вид збоку .....	6
Налаштування: Основи .....	7
Джерела додаткової інформації .....	7
Порядок інсталяції маршрутизатора .....	8
Використання Linksys Smart Wi-Fi .....	11
Підключення до Linksys Smart Wi-Fi .....	11
Карта мережі .....	12
Гостьовий доступ .....	12
Батьківський контроль .....	13
Встановлення пріоритету для пристроїв .....	13
Тест швидкості .....	14
Зовнішні накопичувачі .....	14
Можливості мережевої взаємодії .....	15
Усунення неполадок .....	15
Безпроводне з'єднання .....	16
Безпека .....	16
Усунення неполадок .....	17
Маршрутизатор не було успішно налаштовано .....	17
Повідомлення <i>Your Internet cable is not plugged</i> («Мережевий кабель не під'єднано») .....	18
Повідомлення <i>Cannot access your router</i> («Немає доступу до маршрутизатора») .....	19
Після налаштування .....	21
Інтернет недоступний .....	21
Linksys Smart Wi-Fi не відкривається у браузері .....	22
Технічні характеристики .....	23
Linksys EA8300 .....	23
Екологічний .....	23

# Огляд продукту

## Вигляд зверху

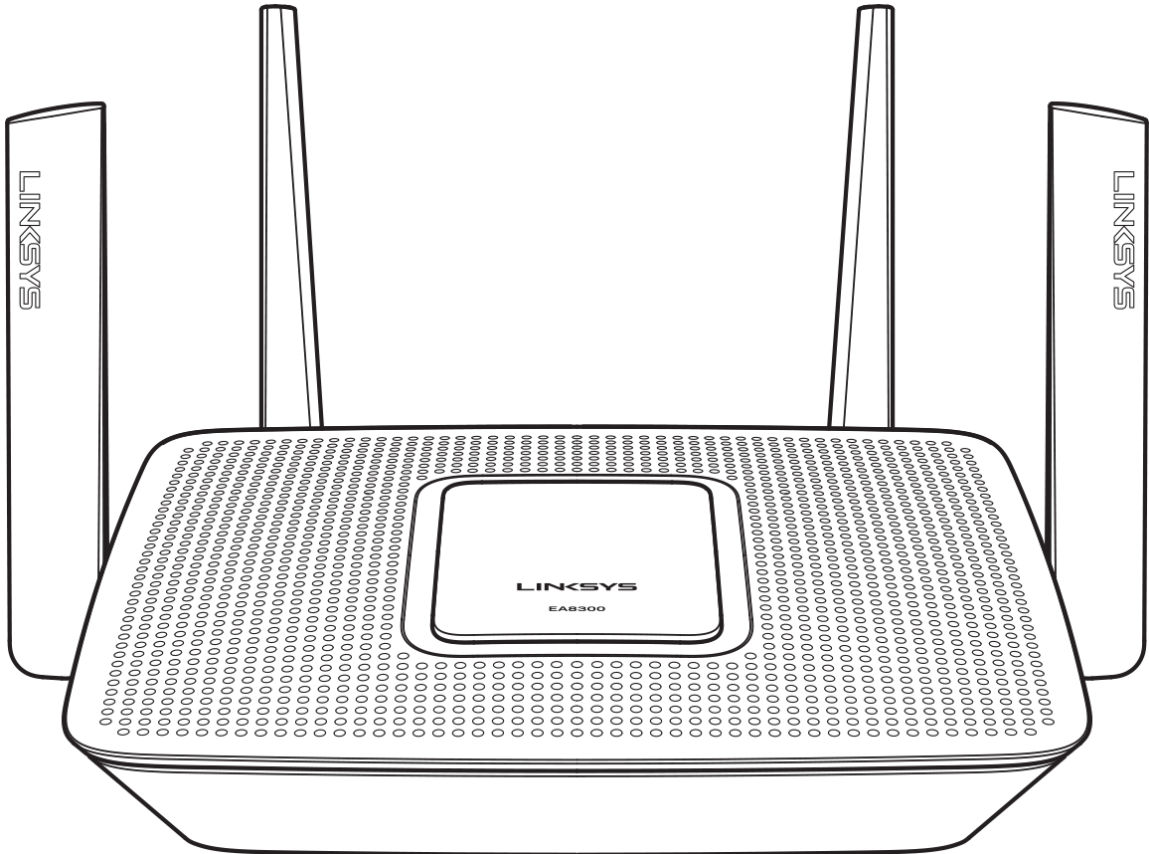

## Індикатор статусу системи

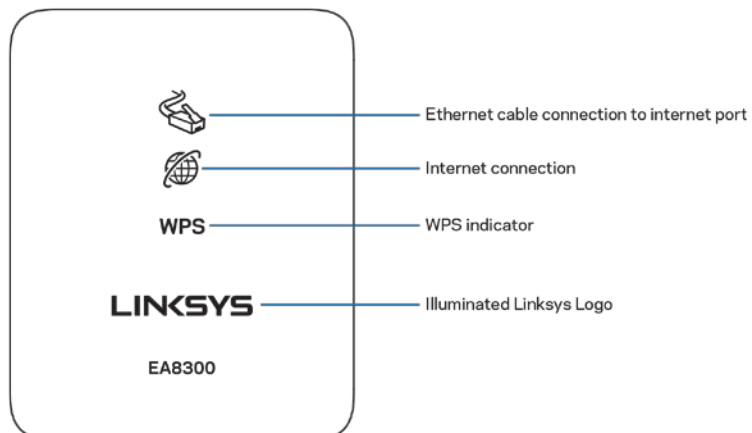

**Підключення кабелю Ethernet до порту Інтернет.** Якщо світиться (оранжевий), вказує на проблему з мережевим кабелем, підключеним до порту Інтернет (WAN).

**Підключення Інтернет.** Якщо світиться (оранжевий), вказує, що маршрутизатор не має доступу до Інтернету.

**Індикатор WPS (Захищене налаштування Wi-Fi™)** У лампочки WPS чотири стани:

<b>Вимкн.</b>	не виконується захищене налаштування Wi-Fi
<b>Миготить білим кольором</b>	виконується захищене налаштування Wi-Fi
<b>Постійно світиться білим кольором</b>	захищене налаштування Wi-Fi виконано, залишається світитися п'ять секунд
<b>Миготить оранжевим кольором</b>	Помилка захищеного налаштування Wi-Fi; миготить одну хвилину, потім згасає

**Емблема Linksys з підсвіткою.** Емблема блимає, поки маршрутизатор запускається. Якщо емблема постійно світиться білим, увімкнене живлення маршрутизатора і він працює правильно.

## Вигляд з тильної сторони

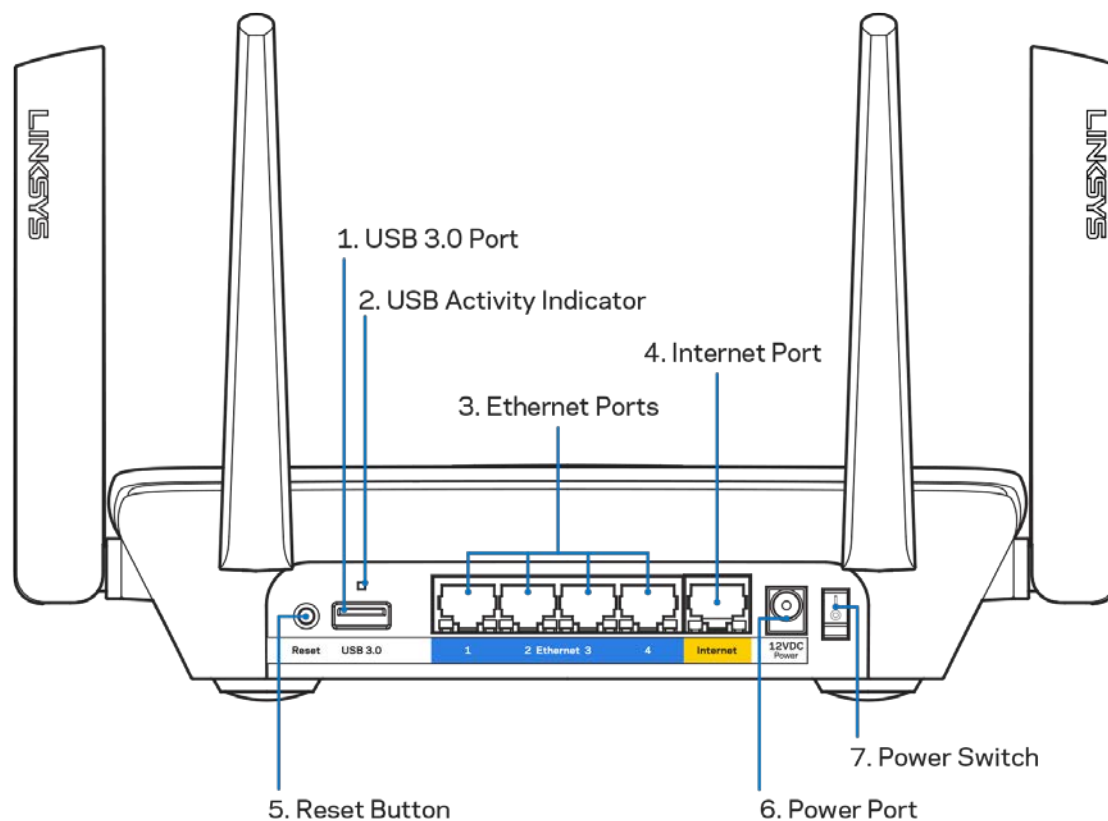

**Порт USB 3.0 (1).** Підключайте та спільно використовуйте носії USB у своїй мережі або в Інтернеті.

**Індикатор активності USB (2)** Світло вказує на передачу даних на зовнішні пристрої або з них.

**Порти Ethernet (3).** Приєднайте кабелі Ethernet до синіх гігабітних портів (10/100/1000) та до проводових пристроїв у Вашій мережі.

*Примітка. Для отримання оптимальних результатів використовуйте кабелі CAT5e або кабелі з кращими параметрами на портах Ethernet.*

**Порт Інтернет (4).**— Підключіть кабель ethernet до цього жовтого гігабітного порту (10/100/1000) і до широкосмугового інтнернет-кабелю/DSL або оптоволоконний модем.

*Примітка. Для отримання оптимальних результатів використовуйте кабелі CAT5e або кабелі з кращими параметрами на портах Інтернет.*

**Кнопка скидання (5).** Натисніть та утримуйте, поки не погасне емблема Linksys, щоб скинути маршрутизатор до заводських налаштувань. Ви також можете відновити заводські налаштування, використовуючи Linksys Smart Wi-Fi в Інтернеті або за допомогою мобільного додатку.

**Порт живлення (6).** Приєднайте зовнішній блок живлення змінного струму, що додається.

**Вимикач живлення (7).**Натисніть | (увімкн.), щоб увімкнути маршрутизатор.



## Вид збоку

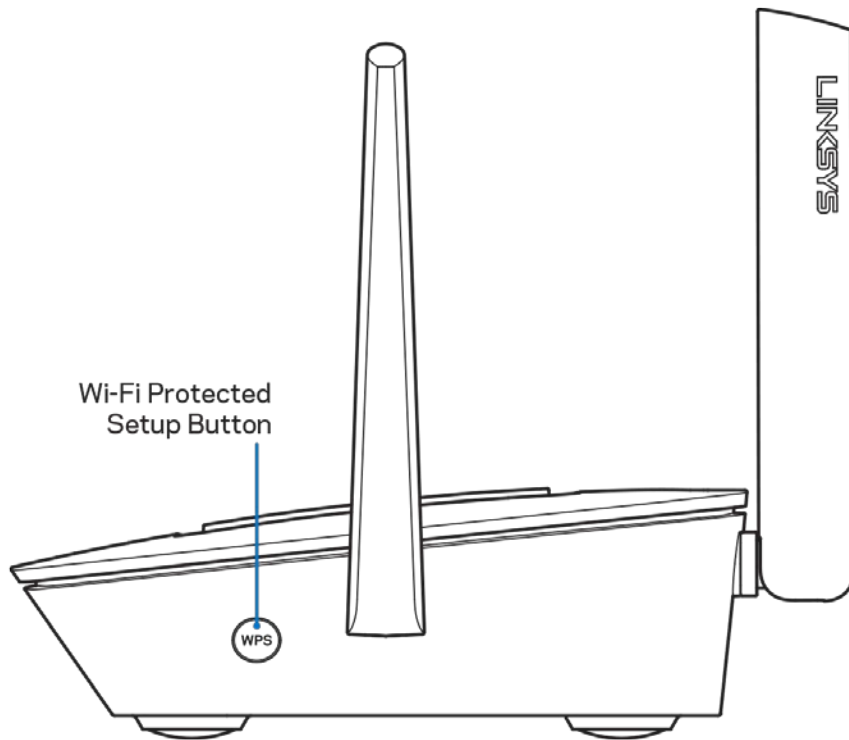

**Кнопка захищеного налаштування Wi-Fi Protected Setup™** Натисніть для приєднання до мережних пристроїв з WPS.

# Налаштування: Основи

## Джерела додаткової інформації

Крім цього Посібника користувача Ви можете отримати допоміжну інформацію за наступною адресою:

- [Linksys.com/support/EA8300](http://Linksys.com/support/EA8300) (документація, завантаження, ЧаПи, технічна підтримка, живий чат, форуми)
- Довідка Linksys Smart Wi-Fi (підключіться до Linksys Smart Wi-Fi і натисніть посилання Довідка у верхній частині екрана)

The screenshot shows the Linksys Smart Wi-Fi mobile application interface. At the top, there is a navigation bar with 'App Center', 'Help' (highlighted with a red circle), 'Linksys15895', and 'Christopher K.'. The main content area is divided into several sections:

- Smart Wi-Fi Tools:** Includes Network Map, Guest Access, Parental Controls, Media Prioritization, Speed Test, and External Storage.
- Router Settings:** Includes Connectivity, Troubleshooting, Wireless, and Security.
- Network Status:** Shows 'Connected' status for 'THIS DEVICE', 'ROUTER', and 'INTERNET'.
- Linksys Home Networking:** Displays 'Performance Perfected' for the new Linksys WRT1900AC.
- Wireless:** Lists 'Linksys15895' on 2.4 GHz and 'Linksys15895\_5GHz' on 5 GHz.
- Guest Access:** Shows 'Guest Network is ON' with details for 2.4 GHz and 5 GHz SSIDs and passwords.
- Network Map:** Shows 'Online devices' with 'Local' devices and wireless devices on 2.4 GHz and 5 GHz.
- Parental Controls:** Shows 'Parental Controls are OFF' and 'Controlled devices: None'.
- External Storage:** Indicates 'There is no drive in the external port.' with a 'Refresh' button.
- Media Prioritization:** Shows 'Media Prioritization is Off' with a 'Prioritize devices' button.

A 'Help' dialog box is open at the bottom, titled 'Using Linksys Smart Wi-Fi'. It provides instructions on how to use the app and lists 'Help Categories' including: Linksys Smart Wi-Fi, Device List, Guest Access, Parental Controls, Media Prioritization, Speed Test, External Storage, and Connectivity. An 'Ok' button is at the bottom of the dialog.

Ліцензії та повідомлення щодо стороннього програмного забезпечення, котре застосовується в даному виробі, можна переглянути за посиланням <http://support.linksys.com/en-us/license>. Перейдіть, будь ласка, за адресою <http://support.linksys.com/en-us/gplcodecenter> для озвучення запитань або запитів щодо програмного коду універсальної суспільної ліцензії.

## Порядок інсталяції маршрутизатора

1. Для завершення налаштування потрібен комп'ютер, щоб перейти на <http://LinksysSmartWiFi.com> у веб-браузері.
2. Ідентифікуйте своє обладнання.

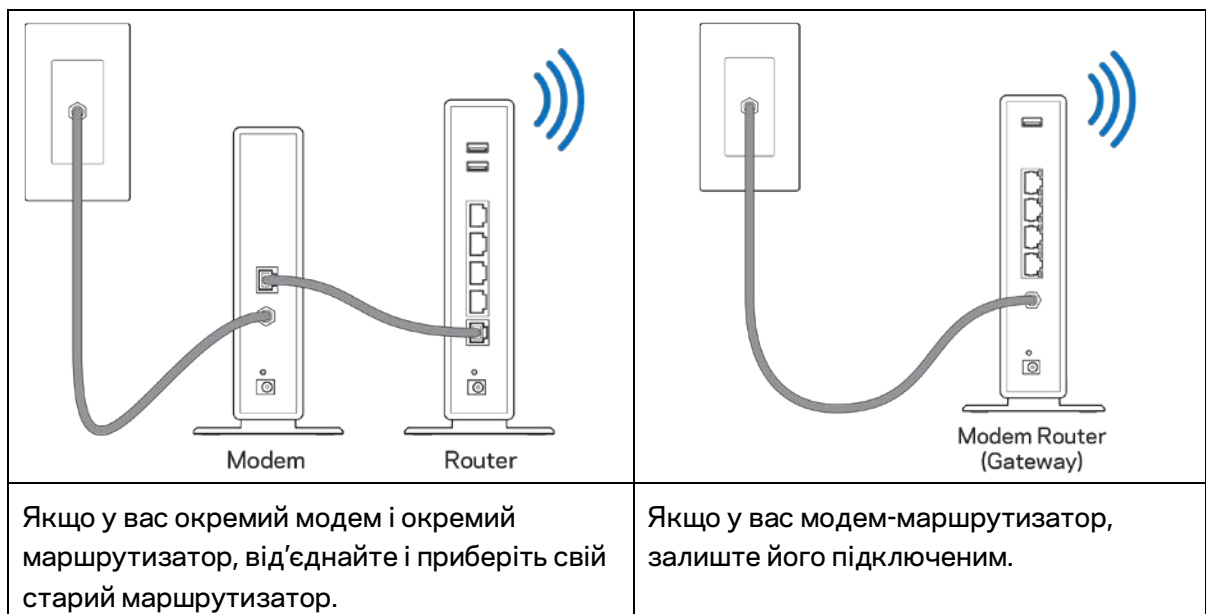

3. Розташуйте антени вертикально вгору та підключіть маршрутизатор до джерела живлення. Переконайтеся, що вимикач живлення у положенні I (увімкн.).
4. Підключіть свій маршрутизатор до модему або модему-маршрутизатора. Підключіть один кінець інтернет-кабелю, що входить до комплекту, до жовтого порту Інтернет на новому маршрутизаторі. Якщо у вас є модем, підключіть інший кінець в порт Ethernet (LAN) на модемі. Якщо у вас є модем-маршрутизатор, підключіть у будь-який доступний порт.
5. Зачекайте, поки логотип Linksys з підсвіткою вгорі маршрутизатора припине блимати і стане безперервно горіти білим.
6. З'єднайтесь з мережею Wi-Fi, назва якої зазначена в Короткому посібнику швидкого старту, отриманому вами разом з маршрутизатором. (Ви можете змінити ці деталі пізніше.) Якщо вам потрібна допомога з підключення до мережі, див. документацію свого пристрою на [linksys.com/support/EA8300](http://linksys.com/support/EA8300).

**Примітка.** Ви не зможете отримати доступ до мережі Інтернет, доки не завершите налаштування маршрутизатора.

7. Введіть <http://LinksysSmartWiFi.com> у веб-браузері. Дотримуйтесь інструкцій на екрані, щоб закінчити налаштування програми маршрутизатора. Також можна ввести 192.168.1.1 в браузері, щоб почати налаштування.

Після закінчення процедури встановлення налаштуйте обліковий запис у системі Linksys Smart Wi-Fi, дотримуючись інструкцій на екрані. Використовуйте Linksys Smart Wi-Fi, щоб налаштувати маршрутизатор з будь-якого комп'ютера з підключенням до Інтернету.

Керування налаштуваннями Вашого маршрутизатора:

- Змінювати ім'я маршрутизатора та пароль
- Налаштовувати доступ для гостей
- Налаштовувати батьківський контроль
- Під'єднувати пристрої до своєї мережі Wi-Fi
- Випробувати швидкість з'єднання з Інтернетом

**Примітка.** Під час налаштування облікового запису Linksys Smart Wi-Fi вам буде надіслано електронний запит для підтвердження. Зі своєї домашньої мережі натисніть на посилання у електронному листі для зв'язку маршрутизатора з обліковим записом Linksys Smart Wi-Fi.

**Порада.** Роздрукуйте наступну сторінку, потім запишіть налаштування свого маршрутизатора та облікового запису у таблицю для довідки. Зберігайте свої записи у надійному місці.

2,4 ГГц, ім'я Wi-Fi	
Пароль Wi-Fi	
5 ГГц <sub>1</sub> ім'я Wi-Fi	
Пароль Wi-Fi	
5 ГГц <sub>2</sub> ім'я Wi-Fi	
Пароль Wi-Fi	
Пароль маршрутизатора	
2,4 ГГц, гостьове ім'я Wi-Fi	
5 ГГц, гостьове ім'я Wi-Fi	
Гостьовий пароль Wi-Fi (однаковий пароль для двох.)	
Ім'я користувача Linksys Smart Wi-Fi	
Пароль Linksys Smart Wi-Fi	

# Використання Linksys Smart Wi-Fi

Ви можете керувати своїм маршрутизатором з будь-якої точки світу, використовуючи Linksys Smart Wi-Fi, а також можете робити це напямую зі своєї домашньої мережі. Linksys Smart Wi-Fi також доступно для мобільного пристрою. Інформацію див. у магазині програм до вашого пристрою.

## Підключення до Linksys Smart Wi-Fi

Підключення до Linksys Smart Wi-Fi

1. Відкрийте браузер на своєму комп'ютері.
2. Перейдіть на <http://LinksysSmartWiFi.com> і ввійдіть до свого облікового запису

Якщо не пам'ятаєте пароль, натисніть *Forgot your password?* (Забули пароль?) і дотримуйтеся інструкцій на екрані для його відновлення.

## Карта мережі

Дозволяє переглядати під'єднані до маршрутизатора пристрої та керувати ними. Можна переглядати пристрої головної мережі та мережі для гостей або отримувати інформацію про кожний пристрій.



## Гостьовий доступ

Дає можливість налаштовувати та контролювати мережу для гостей для Wi-Fi доступу без розкриття особистої інформації.

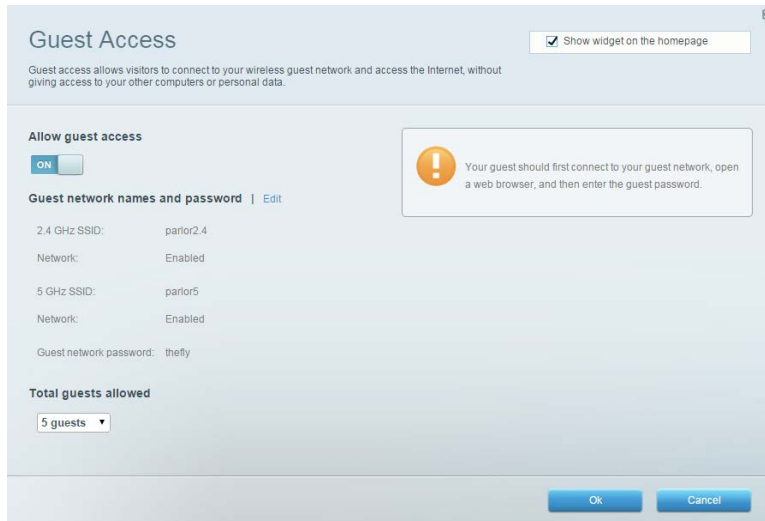

## Батьківський контроль

Дає можливість блокувати певні веб-сайти та обмежувати час доступу до Інтернету.

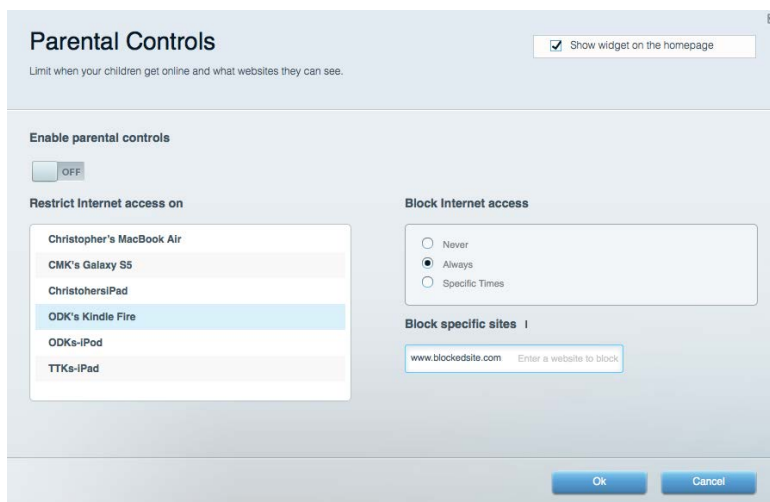

## Встановлення пріоритету для пристроїв

Дозволяє встановити, які пристрої і додатки мають пріоритет у Вашому мережевому трафіку.

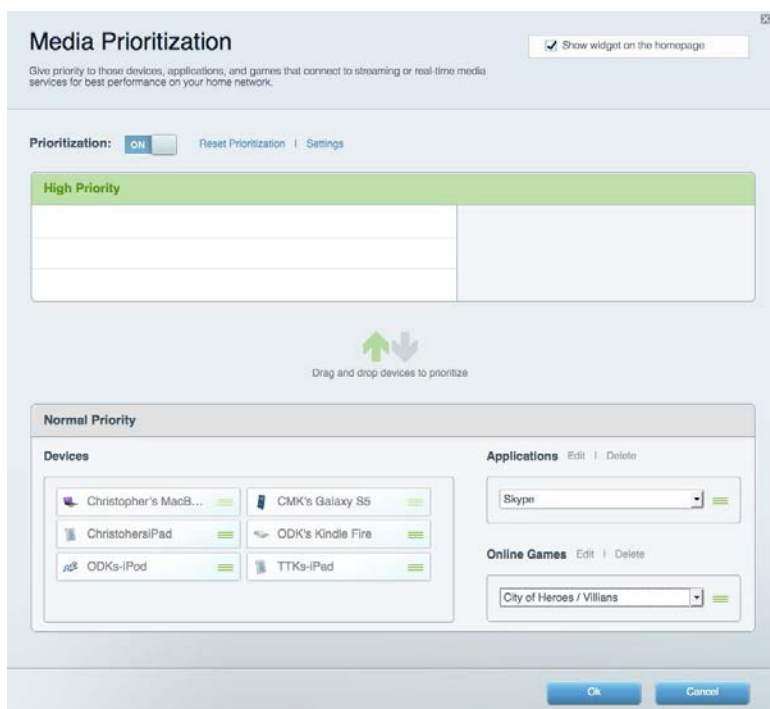



## Тест швидкості

Дозволяє перевірити швидкість з'єднання з мережею Інтернет.

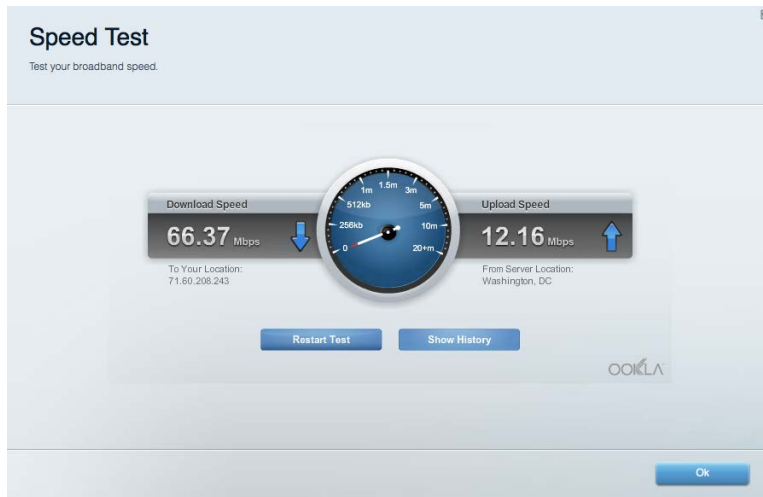

## Зовнішні накопичувачі

Дозволяє отримати доступ до приєднаного USB-носія (не входить в комплект) і налаштувати загальний доступ до файлів, медіа-сервера і до FTP.



## Можливості мережевої взаємодії

Дозволяє переглядати та змінювати основні та розширені налаштування мережі.

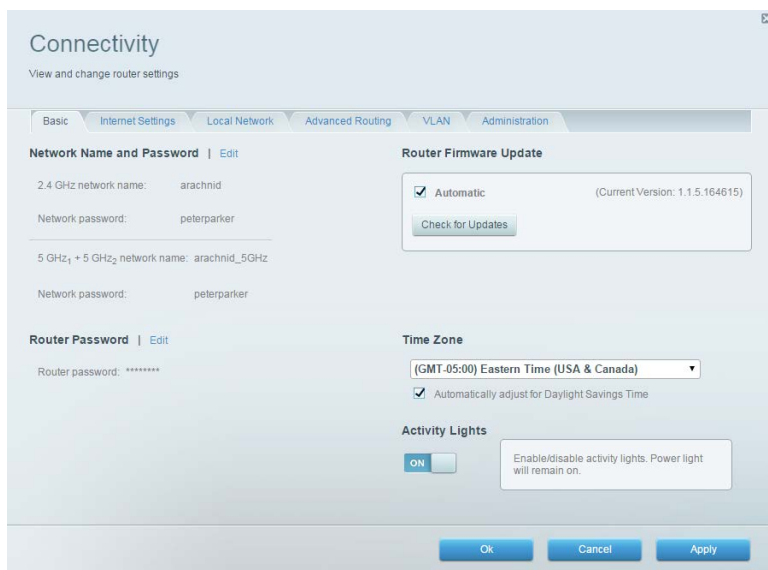

## Усунення неполадок

Містить засоби діагностики проблем із маршрутизатором та перевірки стану мережі.

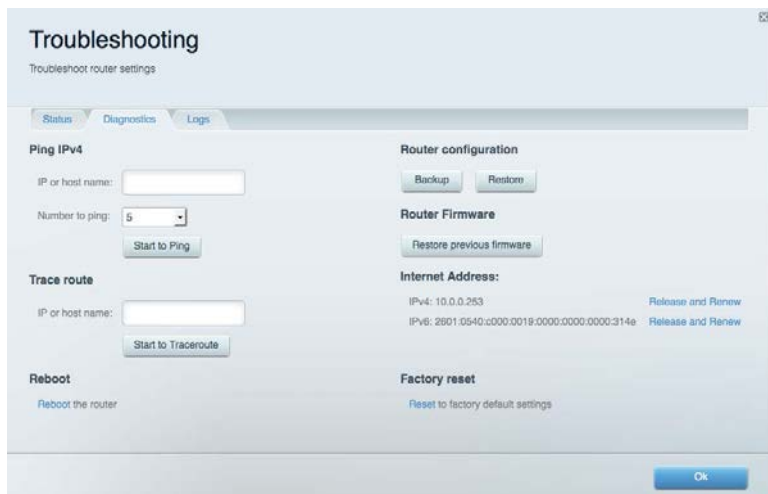

## Безпроводне з'єднання

Дозволяє переглядати та змінювати безпроводну мережу маршрутизатора. Тут можна змінювати мережеве ім'я, режим безпеки та пароль, фільтр MAC-адрес і під'єднувати пристрої за допомогою функції Wi-Fi Protected Setup.

The screenshot shows the 'Wireless' settings page. At the top, there is a checkbox for 'Show widget on the homepage' which is checked. Below this, there are tabs for 'Wireless', 'MAC Filtering', and 'Wi-Fi Protected Setup'. The 'Smart Connect' section has two radio buttons: '5 GHz band steering' (selected) and 'Off'. Below this, there are two network configuration sections. The first is for the 2.4 GHz network, with the name 'arachnid', password 'peterparker', and security mode 'WPA2/WPA Mixed P'. The second is for the 5 GHz network, with the name 'arachnid\_5GHz', password 'peterparker', and security mode 'WPA2/WPA Mixed P'. At the bottom, there are 'Ok', 'Cancel', and 'Apply' buttons.

## Безпека

Дозволяє переглядати та змінювати параметри безпеки безпроводної мережі маршрутизатора. Тут можна налаштовувати параметри брандмауера, VPN, а також індивідуальні параметри для прикладних програм та ігор.

The screenshot shows the 'Security' settings page. At the top, there are tabs for 'Firewall', 'DMZ', and 'Apps and Gaming'. The 'Firewall' section is active and shows several options: 'IPv4 SPI firewall protection' (checked), 'IPv6 SPI firewall protection' (checked), 'IPSec Passthrough' (checked), 'PPTP Passthrough' (checked), and 'L2TP Passthrough' (checked). The 'Internet filters' section has 'Filter anonymous Internet requests' (checked), 'Filter multicast' (unchecked), 'Filter Internet NAT redirection' (unchecked), and 'Filter ident (Port 113)' (checked). At the bottom, there is a table for 'IPv6 Port Services' with columns for 'Description', 'Protocol', 'IPv6 Address', 'Allow', and 'Enabled'. Below the table is a button 'Add IPv6 Firewall Setting'. At the bottom of the page, there are 'Ok', 'Cancel', and 'Apply' buttons.

# Усунення неполадок

Більше допомоги від нашої клієнтської підтримки можна отримати на [linksys.com/support/EA8300](http://linksys.com/support/EA8300).

## Маршрутизатор не було успішно налаштовано

Якщо функція «Linksys Smart Wi-Fi» не виконає успішно налаштування, спробуйте наступне:

- Скріпкою або булавкою натисніть та утримуйте кнопку скидання на маршрутизаторі, доки логотип Linksys з підсвіткою не вимкнеться, а сині індикатори MU-MIMO почнуть блимати (приблизно 10 секунд). Інсталюйте маршрутизатор знову.

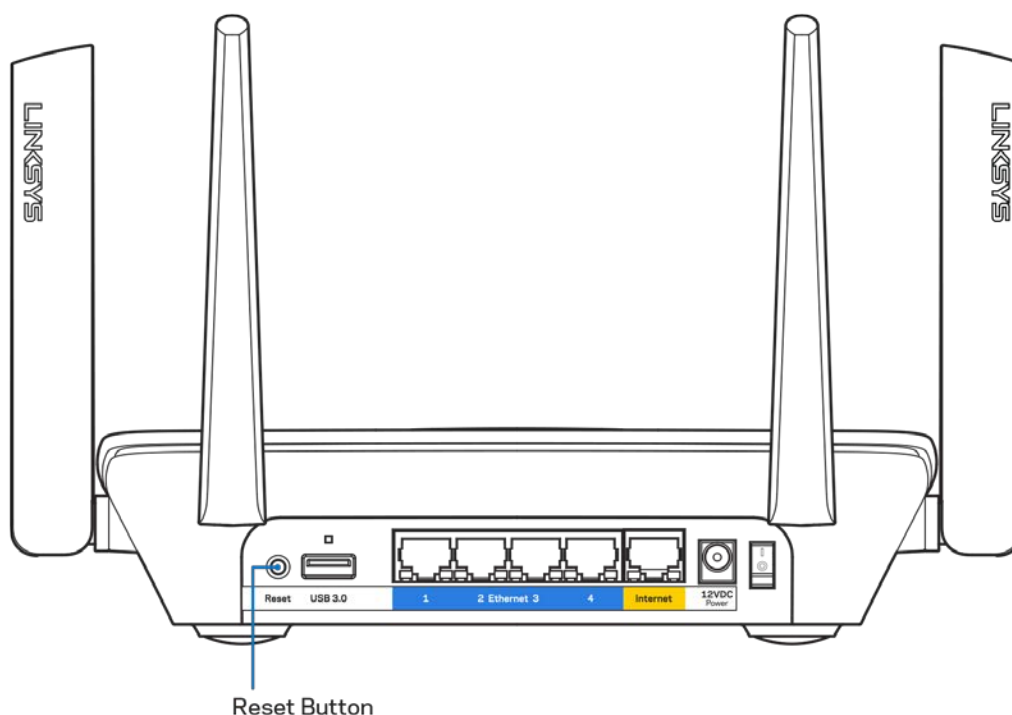

- Тимчасово відключіть брандмауер комп'ютера (для довідки дивіться інструкції щодо програмного забезпечення з питань безпеки). Інсталюйте маршрутизатор знову.
- Якщо у Вас є ще один комп'ютер, тоді скористайтесь ним для повторного налаштування маршрутизатора.

## Повідомлення *Your Internet cable is not plugged* («Мережевий кабель не під'єднано»)

Якщо під час налаштування маршрутизатора ви отримуєте повідомлення «Інтернет кабель не приєднано», дотримуйтесь наступних кроків щодо усунення несправностей.

- Переконайтесь, що кабель мережі Ethernet чи Інтернет (або кабель, що постачається з маршрутизатором) надійно приєднано до жовтого Інтернет-порту з тильної сторони маршрутизатора та до відповідного порту на Вашому модемі. Цей порт на модемі зазвичай марковано як Ethernet.

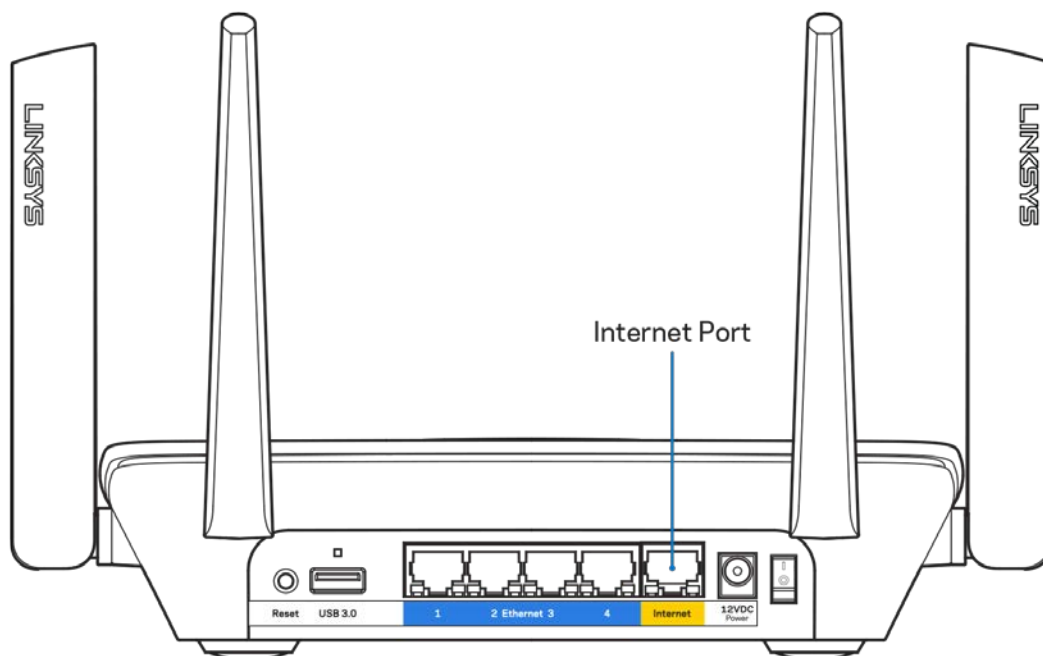

- Переконайтесь, що модем підключений до живлення і включений. Якщо він має вимикач живлення, переконайтесь, що його встановлено в положення ON або I (на противагу O).

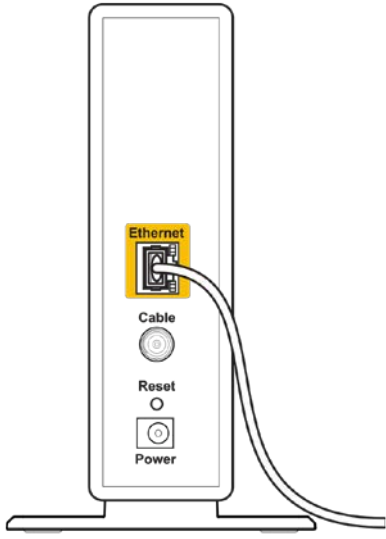
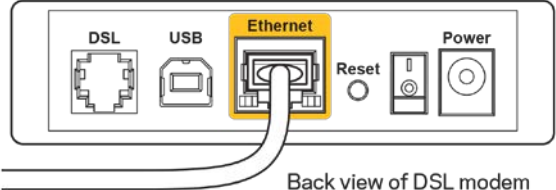
 <p>Back view of cable modem</p>	 <p>Back view of DSL modem</p>
<p>Якщо у Вас кабельний Інтернет, переконайтеся, що до кабельного порту модема CABLE (КАБЕЛЬ) підключений коаксіальний кабель, наданий провайдером.</p>	<p>Якщо у Вас DSL-Інтернет, переконайтеся, що телефонна лінія DSL підключена до порту модема DSL.</p>

- Якщо Ваш комп'ютер був раніше підключений до модему за допомогою кабелю USB, від'єднайте кабель USB.
- Інсталюйте маршрутизатор знову.

## Повідомлення *Cannot access your router («Немає доступу до маршрутизатора»)*

Щоб отримати доступ до маршрутизатора, Ви повинні бути підключені до Вашої мережі. Якщо у Вас є безпроводний доступ до Інтернету, тоді проблема може бути в тому, що Ви випадково підключилися до іншої безпроводної мережі.

Для вирішення цієї проблеми на комп'ютерах під управлінням ОС «Windows» зробіть наступне\*.

1. Натисніть піктограму безпроводної мережі на панелі завдань. З'явиться перелік доступних мереж.

2. Натисніть назву своєї мережі. Натисніть «Підключитися». У наведеному нижче прикладі комп'ютер було з'єднано з іншою безпроводною мережею, котра називається «wraith\_5GHz». У цьому прикладі ім'я безпроводної мережі маршрутизатора Linksys EA8300, Damaged\_Beez2.4, показано обраним.



3. Якщо з'явиться прохання ввести мережевий ключ безпеки, введіть свій пароль (Ключ безпеки) у відповідне поле *мережевого ключа безпеки*. Натисніть **ОК**.
4. Ваш комп'ютер з'єднається з мережею, при цьому Ви повинні мати легкий доступ до маршрутизатора.

*\*Залежно від версії Windows, можуть бути певні відмінності у формулюванні або піктограмах у цих етапах.*

Для вирішення проблеми на комп'ютерах «Mac», зробіть наступне:

1. У рядку меню зверху екрану натисніть на піктограму «Wi-Fi». З'явиться перелік безпроводних мереж.
2. У наведеному нижче прикладі комп'ютер було з'єднано з іншою безпроводною мережею, котра називається «wraith\_5GHz». У цьому прикладі ім'я безпроводної мережі маршрутизатора Linksys EA8300, Damaged\_Beez2.4, показано обраним.

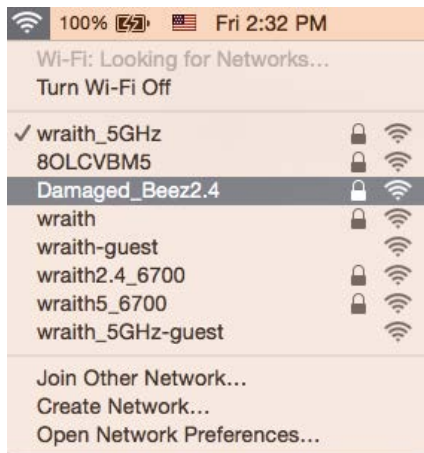

3. Натисніть на ім'я безпроводної мережі свого маршрутизатора Linksys EA8300 (Damaged\_Beez2.4 у цьому прикладі).
4. Введіть пароль своєї безпроводної мережі (Ключ захисту) в поле *Пароль*. Натисніть **ОК**.

## Після налаштування

### Інтернет недоступний

Якщо виникли проблеми зв'язку маршрутизатора з Інтернет, проблема може відобразитися повідомленням "Cannot find [Internet address]" (Неможливо знайти (Інтернет-адреса)) у браузері. Якщо відомо, що адреса в Інтернеті правильна, і якщо ви спробували кілька раз дійсні адреси в Інтернеті з таким самим результатом, повідомлення може означати, що існує проблема у інтернет-провайдера або зв'язку модема з маршрутизатором. Спробуйте наступне.

- Переконайтеся, що мережевий та силовий кабелі надійно підключені.
- Переконайтеся, що на гніздо живлення, до якого підключений маршрутизатор, подається живлення.
- Перезапустіть маршрутизатор.
- Зверніться до інтернет-провайдера і спитайте про збої на ділянці.

Найбільш поширений спосіб виправлення неполадок маршрутизатора - вимкнути, а потім знову увімкнути його. Маршрутизатор може перезавантажити свої клієнтські настройки, а інші пристрої (такі як модем) зможуть знову виявити маршрутизатор та встановити з ним зв'язок. Цей процес називається перезавантаження.

Для перезавантаження маршрутизатора за допомогою силового кабелю виконайте наступне.

1. Від'єднайте силовий кабель від маршрутизатора і модема.
2. Зачекайте 10 секунд і знову підключіть силовий кабель до модема. Переконайтеся у наявності живлення.
3. Зачекайте, поки онлайн індикатори модема припинять блимання (приблизно дві хвилини). Повторно підключіть силовий кабель до маршрутизатора.



4. Зачекайте, поки увімкнеться логотип Linksys з підсвіткою. Зачекайте дві хвилини перед спробою підключення до Інтернет з комп'ютера.

Для перезавантаження маршрутизатора за допомогою Linksys Smart Wi-Fi виконайте наступне.

1. Увійдіть у систему Linksys Smart Wi-Fi. (Див. "Підключення до Linksys Smart Wi-Fi" на сторінці [11](#).)
2. В пункті *Router Settings* (Налаштування маршрутизатора) натисніть *Troubleshooting* (виправлення неполадок).
3. Натисніть на вкладку *Diagnostics* (Діагностика).
4. У пункті *Reboot* (перезавантаження) натисніть *Reboot* (Перезавантаження).



5. Натисніть **Yes (Так)**. Виконається перезавантаження маршрутизатора. Поки маршрутизатор виконує перезавантаження, всі підключені пристрої втратять підключення до Інтернет і автоматично підключаться повторно, коли маршрутизатор буде знову готовий.

## Linksys Smart Wi-Fi не відкривається у браузері

Найновіші версії Google Chrome™, Firefox®, Safari® (для Mac® та iPad®), Microsoft Edge, а також Internet Explorer® версія 8 і новіші працюють з Linksys Smart Wi-Fi.

# Технічні характеристики

## Linksys EA8300

Назва моделі	Тридіапазонний маршрутизатор Max-Stream AC2200 MU-MIMO
Номер моделі	EA8300
Швидкість станційного порту	10/100/1000 Мбіт/с (гігабітний порт Ethernet)
Частота радіохвиль	2,4 та 5 ГГц (x2)
Кількість антен	4 зовнішніх регульованих антени (не знімні)
Порти	USB 3.0, Ethernet (1-4), інтернет, живлення
Кнопки	Захищене налаштування Wi-Fi, живлення, скидання
Лампочки	<b>Верхня панель:</b> емблема Linksys з підсвіткою, захищене налаштування Wi-Fi, підключення Інтернет, підключення мережевого кабелю до порту Інтернет <b>Задня панель:</b> USB, Ethernet (1-4), інтернет
UPnP	Підтримується
Засоби безпеки	WEP, WPA2, RADIUS
Захисні біти ключа	Шифрування з довжиною ключа до 128 біт
Підтримка систем зберігання файлів	FAT, NTFS, і HFS+
Підтримка браузера	Найновіші версії Google Chrome™, Firefox®, Safari® (для Mac® та iPad®), Microsoft Edge та Internet Explorer® версії 8 та новіше

## Екологічний

Розміри	213,7 мм x 161,8 мм x 54,8 мм (без антен)
Вага пристрою	608 г
Живлення	12 В, 2 А
Сертифікати відповідності	FCC, IC, CE, Wi-Fi (a/b/g/n/ac)
Робоча температура	від 0 до 40°C (від 32 до 104°F)
Температура зберігання	від -20 до 60°C (від -4 до 140°F)
Допустима вологість при експлуатації	10-80% відносної вологості, без конденсації
Допустима вологість при зберіганні	від 5 до 90% без конденсації

Технічні характеристики може бути змінено без сповіщення.

## Примітки

Інформацію про норми, гарантію або техніку безпеки див. на компакт-диску в комплекті маршрутизатора або на [Linksys.com/support/EA8300](http://Linksys.com/support/EA8300).

Максимальна продуктивність, розрахована відповідно до стандартів IEEE 802.11. Фактична продуктивність може відрізнятися через низьку пропускну здатність мережі, швидкість передавання даних, діапазон і покриття. Продуктивність залежить від багатьох чинників, умов і змінних, включно з відстанню від точки доступу, обсягом мережного трафіку, матеріалів і конструкції будівлі, наявної операційної системи, сполучення безпроводових пристроїв, перешкод та інших несприятливих умов.

«BELKIN», «LINKSYS» та багато інших назв і логотипів продукції є торговими марками групи компанії «Belkin». Вищезгадані торгові марки третіх сторін є власністю їхніх відповідних власників. Ліцензії та повідомлення щодо стороннього програмного забезпечення, котре застосовується в даному виробі, можна переглянути тут: <http://support.linksys.com/en-us/license>.  
Перейдіть, будь ласка, за адресою <http://support.linksys.com/en-us/gplcodecenter> для запитань або запитів щодо програмного коду універсальної суспільної ліцензії.

© 2017 Belkin International, Inc. та/або її партнерські компанії. Усі права захищено.

**LINKSYS®**

Hướng dẫn Sử dụng

BỘ ĐỊNH TUYẾN BA BĂNG TẦN

MAX-STREAM™  
AC2200 MU-MIMO

Mã sản phẩm EA8300

# Mục lục

Tổng quan Sản phẩm.....	3
Mặt trên.....	3
Đèn báo trạng thái hệ thống.....	4
Mặt sau.....	5
Mặt bên.....	6
Thiết lập: Cơ bản.....	7
Tìm trợ giúp thêm ở đâu.....	7
Cách cài đặt bộ định tuyến.....	8
Cách sử dụng Linksys Smart Wi-Fi.....	11
Cách kết nối với Linksys Smart Wi-Fi.....	11
Network Map (Sơ đồ Mạng).....	12
Guest Access (Truy nhập khách).....	12
Parental Controls (Kiểm soát của cha mẹ).....	13
Media Prioritization (Ưu tiên Phương tiện).....	13
Speed Test (Kiểm tra Tốc độ).....	14
External Storage (Lưu trữ ngoài).....	14
Connectivity (Kết nối).....	15
Troubleshooting (Xử lý sự cố).....	15
Wireless (Không dây).....	16
Security (Bảo mật).....	16
Xử lý sự cố.....	17
Bộ định tuyến của bạn chưa được thiết lập thành công.....	17
Thông báo Chưa cắm cáp Internet.....	18
Thông báo Không thể truy nhập bộ định tuyến.....	19
Sau khi thiết lập.....	21
Mạng Internet không khả dụng.....	21
Linksys Smart Wi-Fi không mở trong trình duyệt web của bạn.....	21
Thông số kỹ thuật.....	22
Linksys EA8300.....	22
Môi trường.....	22

# Tổng quan Sản phẩm

## Mặt trên

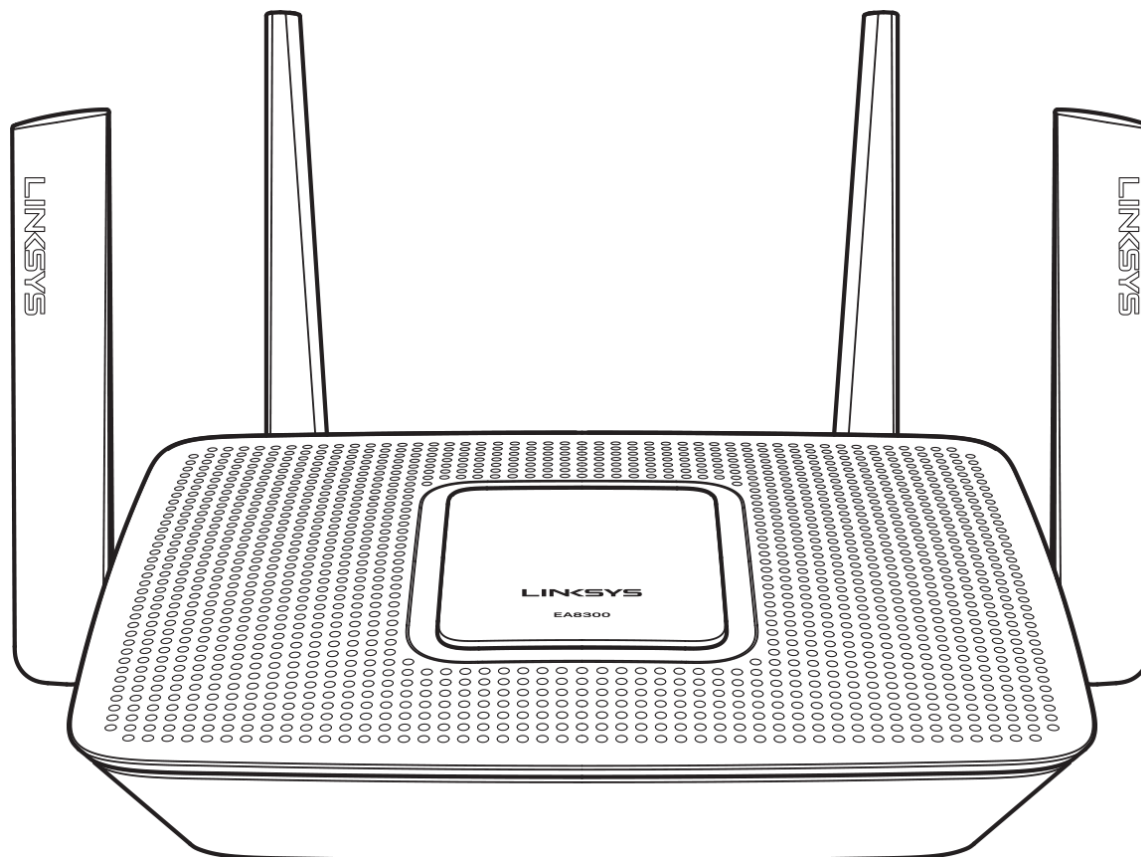

## Đèn báo trạng thái hệ thống

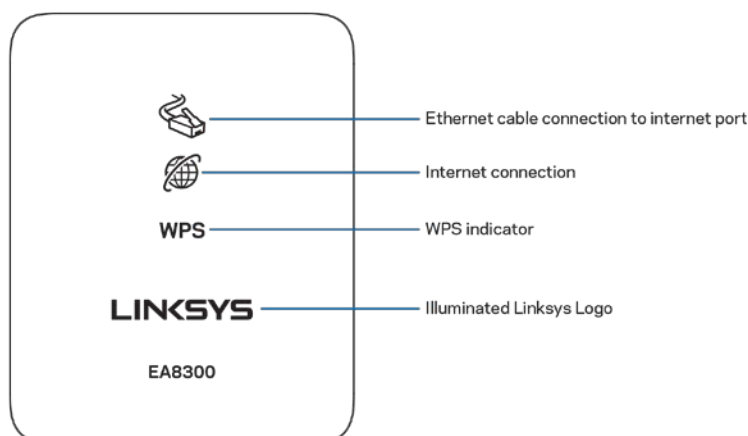

Kết nối cáp Ethernet tới cổng Internet—Đèn sáng (màu da cam) cho biết có vấn đề với cáp mạng kết nối tới cổng Internet (WAN).

Kết nối Internet—Đèn sáng (màu da cam) cho biết bộ định tuyến không thể truy nhập Internet.

Đèn báo WPS (Wi-Fi Protected Setup™)—Đèn WPS có bốn trạng thái:

Tắt	Không có hoạt động Wi-Fi Protected Setup
Nhấp nháy màu trắng	Đang tiến hành Wi-Fi Protected Setup
Sáng ổn định màu trắng	Wi-Fi Protected Setup thành công; sáng trong năm giây
Nhấp nháy màu da cam	Wi-Fi Protected Setup gặp lỗi; nhấp nháy trong một phút, sau đó tắt

Logo Linksys phát sáng—Logo nhấp nháy khi bộ định tuyến đang khởi động. Logo sáng ổn định màu trắng tức là bộ định tuyến đã được bật nguồn và đang hoạt động ổn định.

## Mặt sau

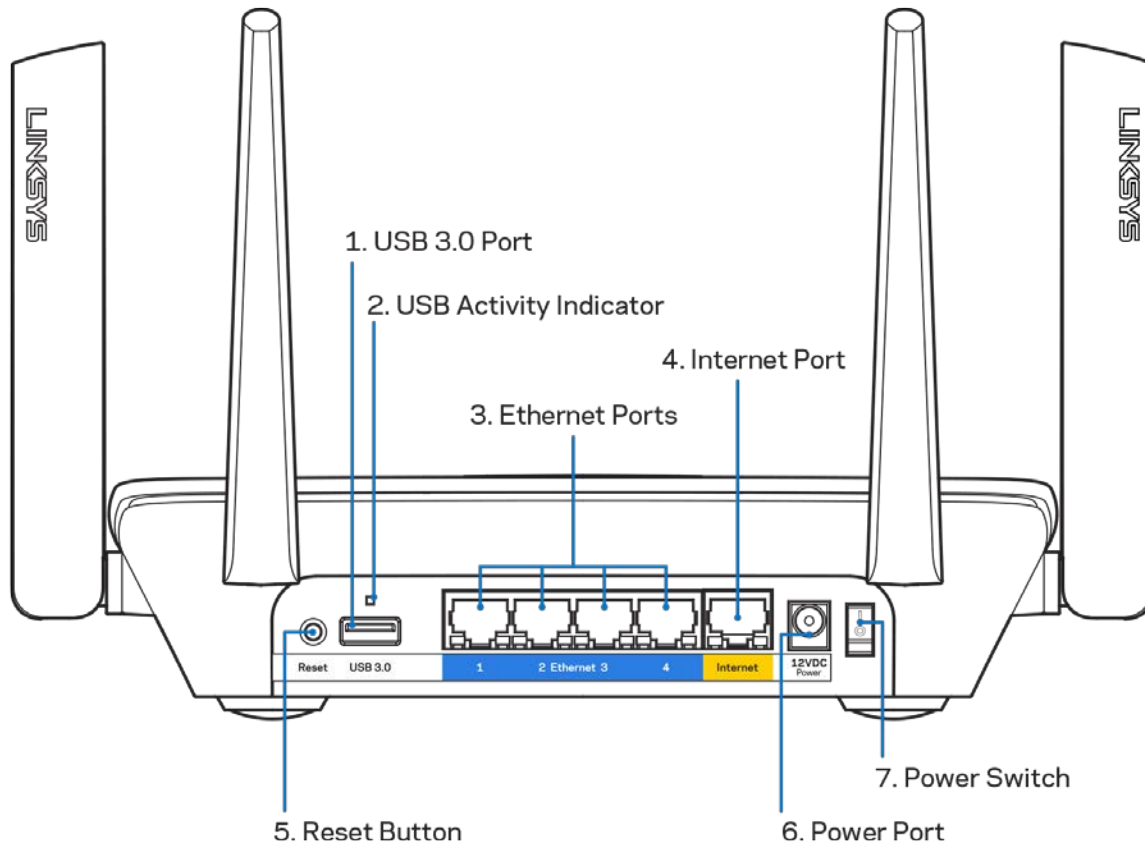

Cổng USB 3.0 (1)— Kết nối và chia sẻ các ổ đĩa USB trên mạng của bạn hoặc trên Internet.

Đèn báo hoạt động USB (2)— Đèn cho biết dữ liệu truyền đến/đi từ các thiết bị bên ngoài.

Cổng Ethernet (3)— Kết nối cáp Ethernet với các cổng gigabit màu xanh (10/100/1000) và với các thiết bị nối dây trong mạng của bạn.

**Lưu ý—Để đạt hiệu suất tốt nhất, hãy dùng cáp CAT5e hoặc loại cáp chất lượng cao hơn trên cổng Ethernet.**

Cổng Internet (4)— Kết nối cáp Ethernet với cổng gigabit (10/100/1000) màu vàng này và với modem cáp Internet băng rộng/DSL hoặc modem cáp quang.

**Lưu ý—Để đạt hiệu suất tốt nhất, hãy dùng cáp CAT5e hoặc loại cáp chất lượng cao hơn trên cổng Internet.**

Nút Reset (Đặt lại) (5)— Ấn và giữ cho đến khi logo Linksys tắt sáng để đặt lại bộ định tuyến về cài đặt gốc. Bạn cũng có thể khôi phục cài đặt gốc bằng cách sử dụng Linksys Smart Wi-Fi trên Internet hoặc ứng dụng di động.

Cổng nguồn (6)— Kết nối bộ chuyển đổi nguồn điện AC đi kèm.

Công tắc nguồn (7)— Ấn | (on) để bật bộ định tuyến.



## Mặt bên

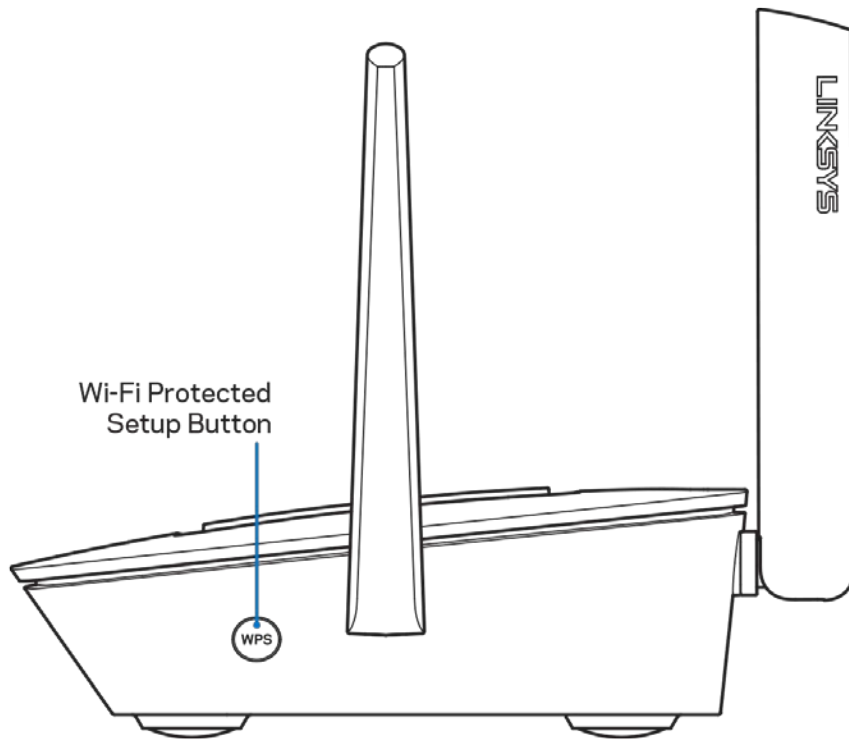

Nút Wi-Fi Protected Setup™—Ấn để kết nối với các thiết bị mạng hỗ trợ WPS.

# Thiết lập: Cơ bản

## Tìm trợ giúp thêm ở đâu

Ngoài hướng dẫn sử dụng này, bạn có thể tìm trợ giúp ở các địa chỉ sau:

- [Linksys.com/support/EA8300](http://Linksys.com/support/EA8300) (tài liệu, nội dung tải xuống, câu hỏi thường gặp, hỗ trợ kỹ thuật, trò chuyện trực tiếp, diễn đàn)
- Trợ giúp Linksys Smart Wi-Fi (kết nối với Linksys Smart Wi-Fi, sau đó bấm Help (Trợ giúp) ở phía trên cùng của màn hình)

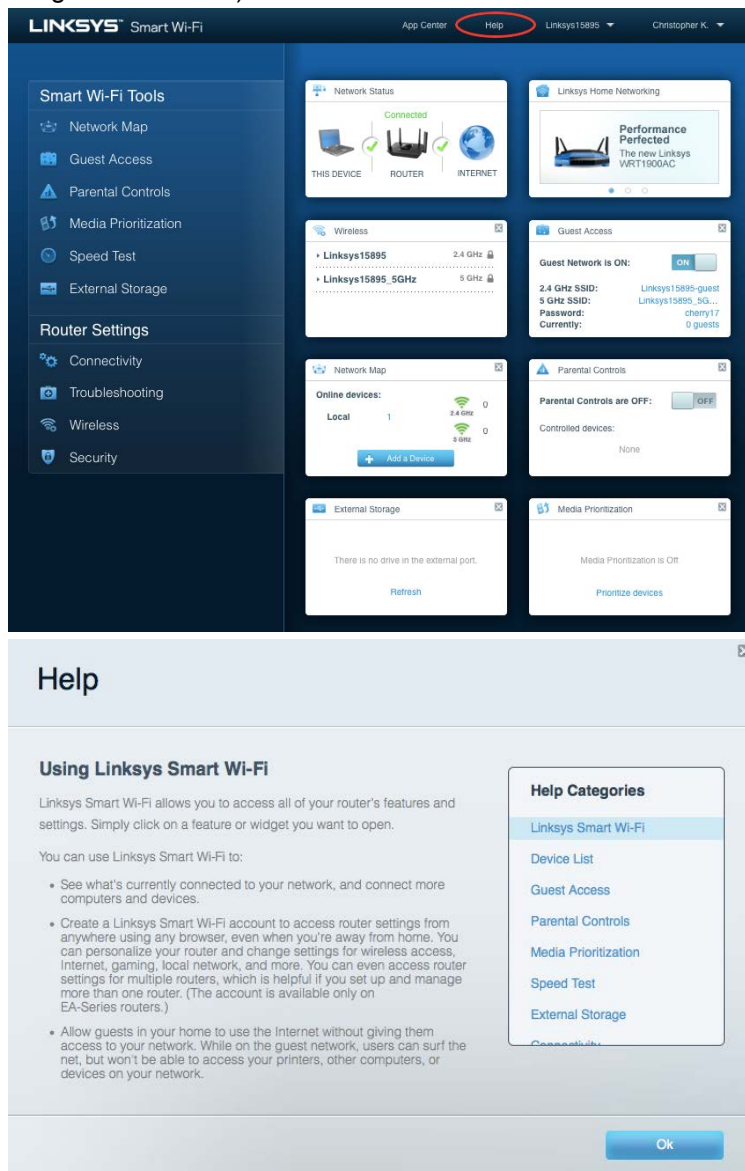

The screenshot shows the Linksys Smart Wi-Fi app interface. At the top, there is a navigation bar with 'App Center', 'Help' (circled in red), 'Linksys15895', and 'Christopher K.'. The main interface is divided into a left sidebar with 'Smart Wi-Fi Tools' and 'Router Settings', and a main content area with various widgets like 'Network Status', 'Wireless', 'Guest Access', 'Network Map', 'Parental Controls', 'External Storage', and 'Media Prioritization'. Below the app interface is a 'Help' dialog box with the title 'Using Linksys Smart Wi-Fi'. The dialog box contains the following text:

**Using Linksys Smart Wi-Fi**

Linksys Smart Wi-Fi allows you to access all of your router's features and settings. Simply click on a feature or widget you want to open.

You can use Linksys Smart Wi-Fi to:

- See what's currently connected to your network, and connect more computers and devices.
- Create a Linksys Smart Wi-Fi account to access router settings from anywhere using any browser, even when you're away from home. You can personalize your router and change settings for wireless access, Internet, gaming, local network, and more. You can even access router settings for multiple routers, which is helpful if you set up and manage more than one router. (The account is available only on EA-Series routers.)
- Allow guests in your home to use the Internet without giving them access to your network. While on the guest network, users can surf the net, but won't be able to access your printers, other computers, or devices on your network.

**Help Categories**

- Linksys Smart Wi-Fi
- Device List
- Guest Access
- Parental Controls
- Media Prioritization
- Speed Test
- External Storage
- Connectivity

At the bottom of the dialog box is an 'Ok' button.

Lưu ý—Các giấy phép và thông báo cho các phần mềm của bên thứ ba được sử dụng trong sản phẩm này có thể xem tại <http://support.linksys.com/en-us/license>. Vui lòng liên hệ <http://support.linksys.com/en-us/gplcodecenter> nếu có câu hỏi hoặc yêu cầu mã nguồn GPL.

## Cách cài đặt bộ định tuyến

1. Để hoàn tất thiết lập, bạn cần có máy tính để truy cập <http://LinksysSmartWiFi.com> bằng trình duyệt web.
2. Xác định rõ các thiết bị của bạn.

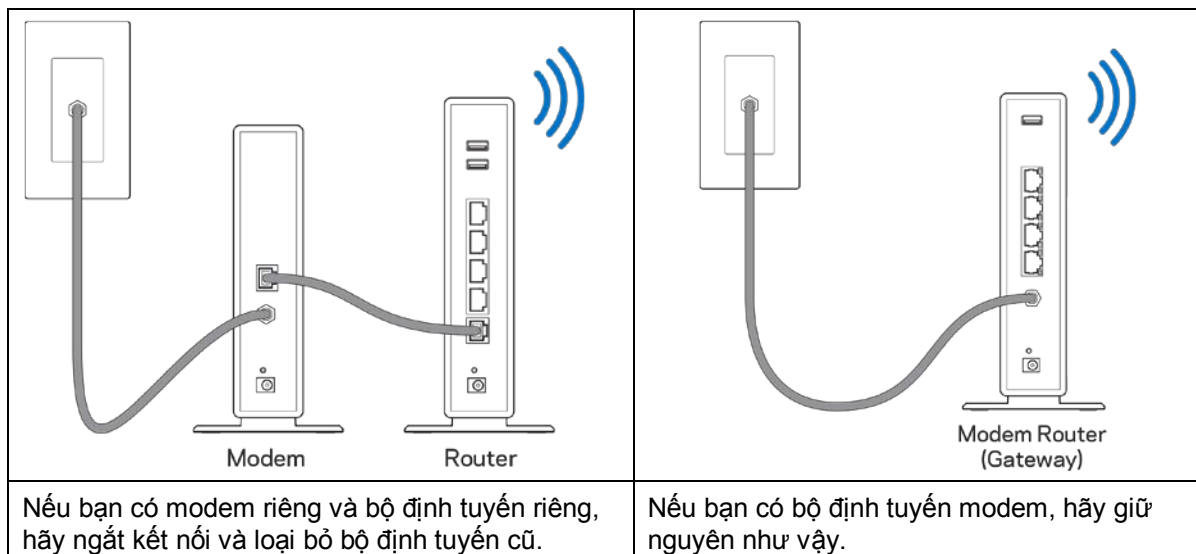

3. Đặt các ăng-ten thẳng đứng và cắm nguồn điện cho bộ định tuyến. Hãy chắc chắn rằng công tắc nguồn đã ở vị trí | (on).
4. Kết nối bộ định tuyến với modem hoặc bộ định tuyến modem của bạn. Cắm một đầu của cáp Internet đi kèm vào cổng Internet màu vàng trên bộ định tuyến mới của bạn. Nếu bạn có modem, hãy cắm đầu còn lại vào cổng Ethernet (LAN) trên modem. Nếu bạn có bộ định tuyến modem, hãy cắm nó vào bất kỳ cổng nào còn trống.
5. Đợi đến khi đèn Linksys ở mặt trên của bộ định tuyến dừng nhấp nháy và sáng ổn định màu trắng.
6. Kết nối với tên Wi-Fi ghi trong Hướng dẫn Sử dụng Nhanh đi kèm cùng bộ định tuyến. (Bạn có thể thay đổi các chi tiết này sau). Nếu bạn cần trợ giúp kết nối mạng, hãy tham khảo tài liệu của thiết bị tại địa chỉ [linksys.com/support/EA8300](http://linksys.com/support/EA8300).

**Lưu ý**—Bạn sẽ không thể truy nhập Internet cho đến khi hoàn tất quá trình thiết lập bộ định tuyến.

7. Nhập <http://LinksysSmartWiFi.com> vào trình duyệt web. Làm theo hướng dẫn trên màn hình để hoàn tất cài đặt bộ định tuyến. Bạn cũng có thể nhập 192.168.1.1 vào trình duyệt để bắt đầu thiết lập.

Cuối quá trình thiết lập, hãy thực hiện theo hướng dẫn trên màn hình để thiết lập tài khoản Linksys Smart Wi-Fi. Sử dụng Linksys Smart Wi-Fi để đặt cấu hình bộ định tuyến từ bất kỳ máy tính nào có kết nối Internet.

Quản lý cài đặt bộ định tuyến:

- Thay đổi tên và mật khẩu của bộ định tuyến
- Thiết lập truy nhập khách
- Cấu hình kiểm soát của cha mẹ
- Kết nối thiết bị với Wi-Fi của bạn
- Kiểm tra tốc độ kết nối Internet

Lưu ý—Trong quá trình thiết lập tài khoản Linksys Smart Wi-Fi, bạn sẽ nhận được một e-mail xác minh. Từ mạng gia đình của bạn, bấm vào liên kết trong email để liên kết bộ định tuyến của bạn với tài khoản Linksys Smart Wi-Fi.

Mẹo—Hãy in trang kế tiếp, sau đó ghi các cài đặt của tài khoản và bộ định tuyến của bạn vào bảng để tham khảo. Giữ các ghi chú của bạn ở nơi an toàn.

Tên Wi-Fi 2.4 GHz	
Mật khẩu Wi-Fi	
Tên Wi-Fi 5 GHz <sub>1</sub>	
Mật khẩu Wi-Fi	
Tên Wi-Fi 5 GHz <sub>2</sub>	
Mật khẩu Wi-Fi	
Mật khẩu Bộ định tuyến	
Tên Wi-Fi Khách 2.4 GHz	
Tên Wi-Fi Khách 5GHz	
Mật khẩu Wi-Fi Khách (Cả hai chung một mật khẩu).	
Tên người dùng Linksys Smart Wi-Fi	
Mật khẩu Linksys Smart Wi-Fi	

# Cách sử dụng Linksys Smart Wi-Fi

Bạn có thể quản lý bộ định tuyến từ bất kỳ đâu trên thế giới bằng cách sử dụng Linksys Smart Wi-Fi, tuy nhiên bạn cũng có thể quản lý trực tiếp từ mạng gia đình của mình. Ngoài ra, bạn còn có thể sử dụng Linksys Smart Wi-Fi trên thiết bị di động. Xem cửa hàng ứng dụng của thiết bị của bạn để biết thêm thông tin.

## Cách kết nối với Linksys Smart Wi-Fi

Để kết nối với Linksys Smart Wi-Fi:

1. Mở trình duyệt web trên máy tính của bạn.
2. Truy cập <http://LinksysSmartWiFi.com> và đăng nhập tài khoản của bạn.

Nếu bạn không nhớ mật khẩu, hãy bấm *Forgot your password?* (Quên mật khẩu?) và làm theo hướng dẫn trên màn hình để khôi phục lại mật khẩu.

## Network Map (Sơ đồ Mạng)

Cho phép bạn hiển thị và quản lý tất cả các thiết bị mạng được kết nối với bộ định tuyến. Bạn có thể xem các thiết bị trên mạng chính và mạng khách, hoặc hiển thị thông tin về từng thiết bị.

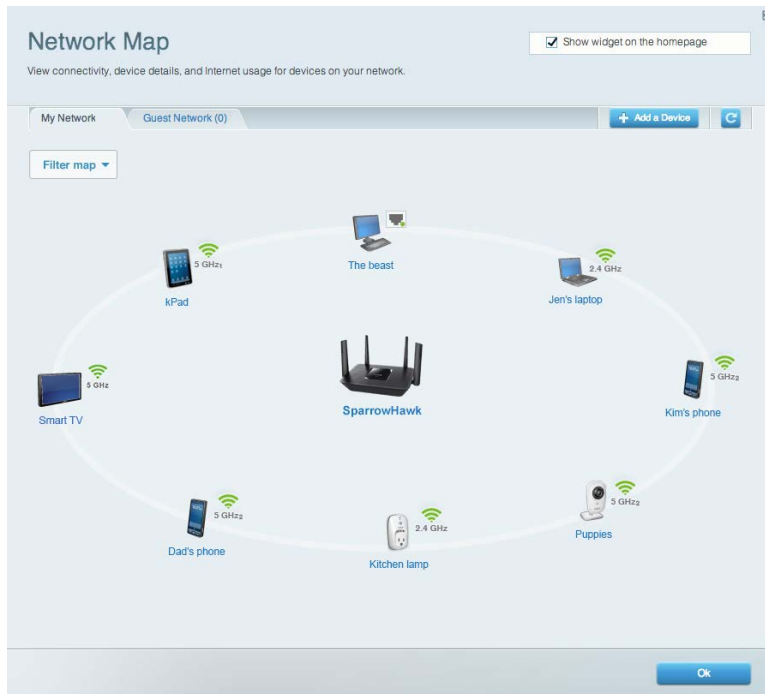

## Guest Access (Truy nhập khách)

Cho phép bạn thiết lập và giám sát một mạng riêng cho các vị khách truy cập Wi-Fi mà vẫn bảo đảm an toàn cho các thông tin cá nhân.

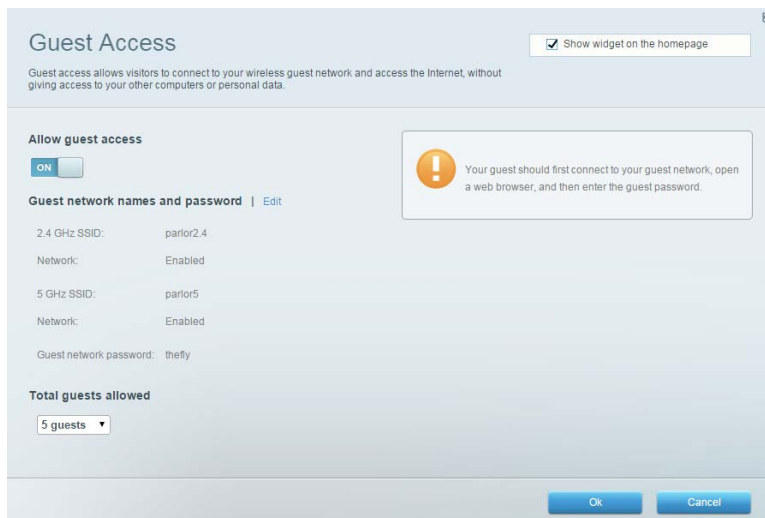

## Parental Controls (Kiểm soát của cha mẹ)

Cho phép bạn chặn các trang web và quy định thời gian truy nhập Internet.

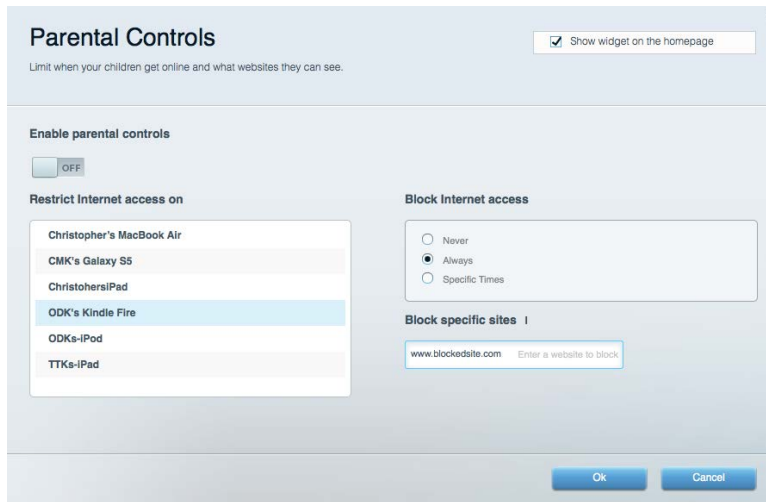

## Media Prioritization (Ưu tiên Phương tiện)

Cho phép bạn quy định những thiết bị và ứng dụng nào được ưu tiên hàng đầu về lưu lượng mạng.

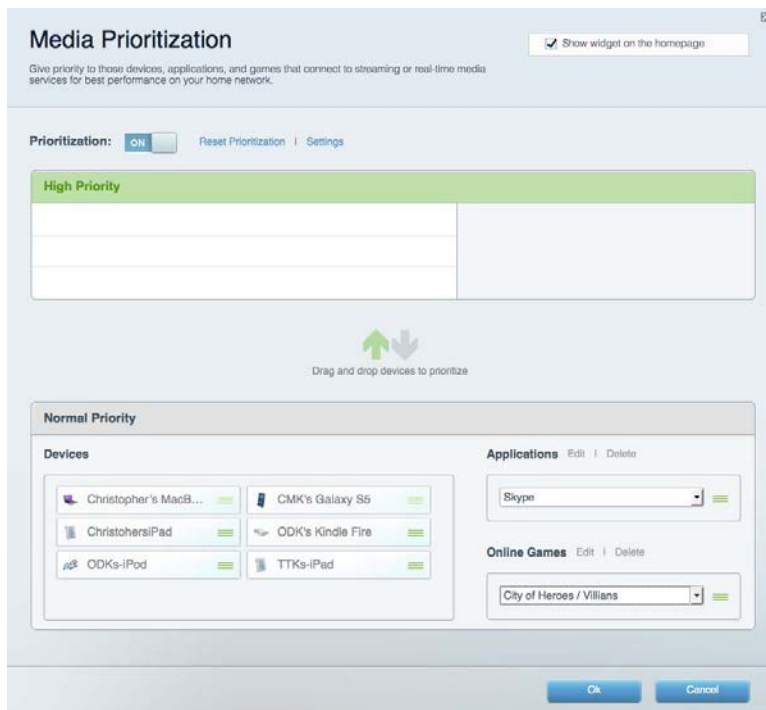



## Speed Test (Kiểm tra Tốc độ)

Cho phép bạn kiểm tra tốc độ kết nối Internet của mạng.



## External Storage (Lưu trữ ngoài)

Cho phép bạn truy nhập ổ đĩa USB (không đi kèm) cắm vào thiết bị và thiết lập chia sẻ tệp tin, máy chủ phương tiện và truy nhập FTP.

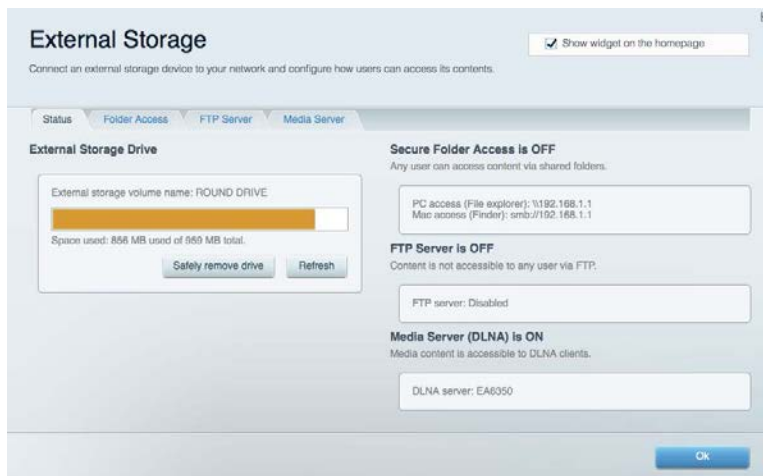

## Connectivity (Kết nối)

Cho phép bạn xem và thay đổi các cài đặt mạng cơ bản và nâng cao.

The screenshot shows the 'Connectivity' settings page. It has a title bar 'Connectivity' and a subtitle 'View and change router settings'. Below the title bar are tabs: 'Basic', 'Internet Settings', 'Local Network', 'Advanced Routing', 'VLAN', and 'Administration'. The 'Internet Settings' tab is selected. The page is divided into several sections: 'Network Name and Password' with fields for 2.4 GHz and 5 GHz network names and passwords; 'Router Password' with a password field; 'Router Firmware Update' with a checked 'Automatic' option and a 'Check for Updates' button; 'Time Zone' with a dropdown menu set to '(GMT-05:00) Eastern Time (USA & Canada)' and a checked 'Automatically adjust for Daylight Savings Time' option; and 'Activity Lights' with an 'ON' toggle and a text box explaining the feature. At the bottom are 'Ok', 'Cancel', and 'Apply' buttons.

## Troubleshooting (Xử lý sự cố)

Cho phép bạn chẩn đoán các vấn đề của bộ định tuyến và kiểm tra trạng thái mạng.

The screenshot shows the 'Troubleshooting' page. It has a title bar 'Troubleshooting' and a subtitle 'Troubleshoot router settings'. Below the title bar are tabs: 'Status', 'Diagnostics', and 'Logs'. The 'Diagnostics' tab is selected. The page is divided into several sections: 'Ping IPv4' with input fields for IP or host name and number of pings, and a 'Start to Ping' button; 'Trace route' with an input field for IP or host name and a 'Start to Traceroute' button; 'Reboot' with a 'Reboot the router' link; 'Router configuration' with 'Backup' and 'Restore' buttons; 'Router Firmware' with a 'Restore previous firmware' button; 'Internet Address' showing IPv4 and IPv6 addresses with 'Release and Renew' links; and 'Factory reset' with a 'Reset to factory default settings' link. At the bottom is an 'Ok' button.

## Wireless (Không dây)

Cho phép bạn xem và thay đổi mạng không dây của bộ định tuyến. Bạn có thể thay đổi các tên mạng, chế độ bảo mật, mật khẩu, lọc MAC và kết nối các thiết bị bằng cách sử dụng Wi-Fi Protected Setup.

Wireless

View and change router settings

Wireless MAC Filtering Wi-Fi Protected Setup

Smart Connect:  5 GHz band steering (5 GHz<sub>1</sub> + 5 GHz<sub>2</sub>)  Off (Individual networks) [What is Smart Connect band steering?](#)

Network name: arachnid 2.4 GHz Network:  ON

Password: peterparker Broadcast SSID: Yes Channel: Auto

Security mode: WPA2/WPA Mixed Pt Network mode: Mixed Channel width: Auto

Network name: arachnid\_5GHz 5 GHz<sub>1</sub> + 5 GHz<sub>2</sub> Network:  ON

Password: peterparker Broadcast SSID: Yes Channel: Auto

Security mode: WPA2/WPA Mixed Pt Network mode: Auto Channel width: Auto

Ok Cancel Apply

## Security (Bảo mật)

Cho phép bạn xem và thay đổi bảo mật không dây của bộ định tuyến. Bạn có thể thiết lập tường lửa, cài đặt VPN và tạo cài đặt tùy chỉnh cho các ứng dụng và trò chơi.

Security

View and change router settings

Firewall DMZ Apps and Gaming

**Firewall**

IPv4 SPI firewall protection  Enabled

IPv6 SPI firewall protection  Enabled

**VPN Passthrough**

IPSec Passthrough  Enabled

PPTP Passthrough  Enabled

L2TP Passthrough  Enabled

**Internet filters**

Filter anonymous Internet requests

Filter multicast

Filter Internet NAT redirection

Filter ident (Port 113)

**IPv6 Port Services**

Description	Protocol	IPv6 Address	Allow	Enabled
-------------	----------	--------------	-------	---------

Add IPv6 Firewall Setting

Ok Cancel Apply

# Xử lý sự cố

Bạn có thể tìm thêm trợ giúp từ bộ phận hỗ trợ khách hàng đã giành nhiều giải thưởng của chúng tôi tại địa chỉ [linksys.com/support/EA8300](https://linksys.com/support/EA8300).

## Bộ định tuyến của bạn chưa được thiết lập thành công

Nếu Linksys Smart Wi-Fi không hoàn tất thiết lập, bạn có thể thử cách sau:

- Ấn và giữ nút Reset (Đặt lại) trên bộ định tuyến bằng một cây kẹp giấy hoặc đinh ghim cho đến khi logo Linksys tắt sáng và các đèn báo MU-MIMO màu xanh bắt đầu nhấp nháy (khoảng 10 giây). Cài đặt lại bộ định tuyến.

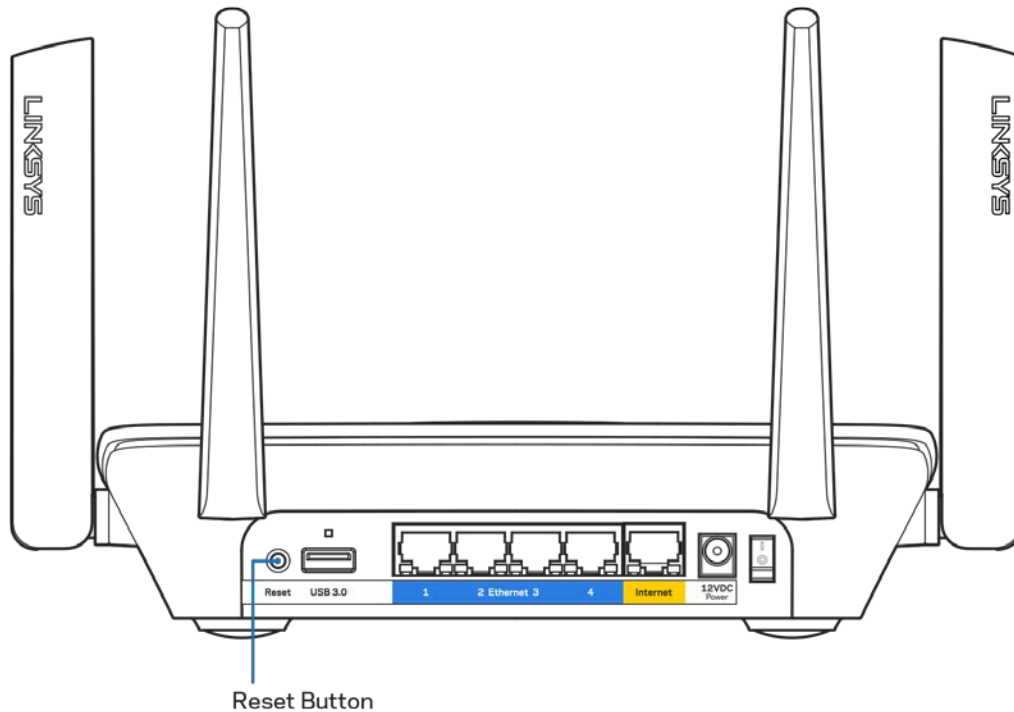

- Tạm thời tắt tường lửa trên máy tính của bạn (xem hướng dẫn của phần mềm bảo mật để được trợ giúp). Cài đặt lại bộ định tuyến.
- Nếu bạn có máy tính khác, hãy sử dụng máy tính đó để cài đặt lại bộ định tuyến.

## Thông báo Chưa cắm cáp Internet

Nếu bạn nhận được thông báo “Chưa cắm cáp Internet” khi đang cài đặt bộ định tuyến, hãy làm theo các bước khắc phục sự cố sau.

- Hãy chắc chắn rằng cáp Ethernet hoặc Internet (hoặc cáp giống với loại được cung cấp cùng với bộ định tuyến) đã được cắm chắc chắn vào cổng Internet màu vàng ở mặt sau của bộ định tuyến và vào cổng thích hợp trên modem. Cổng này trên modem thường có nhãn Ethernet.

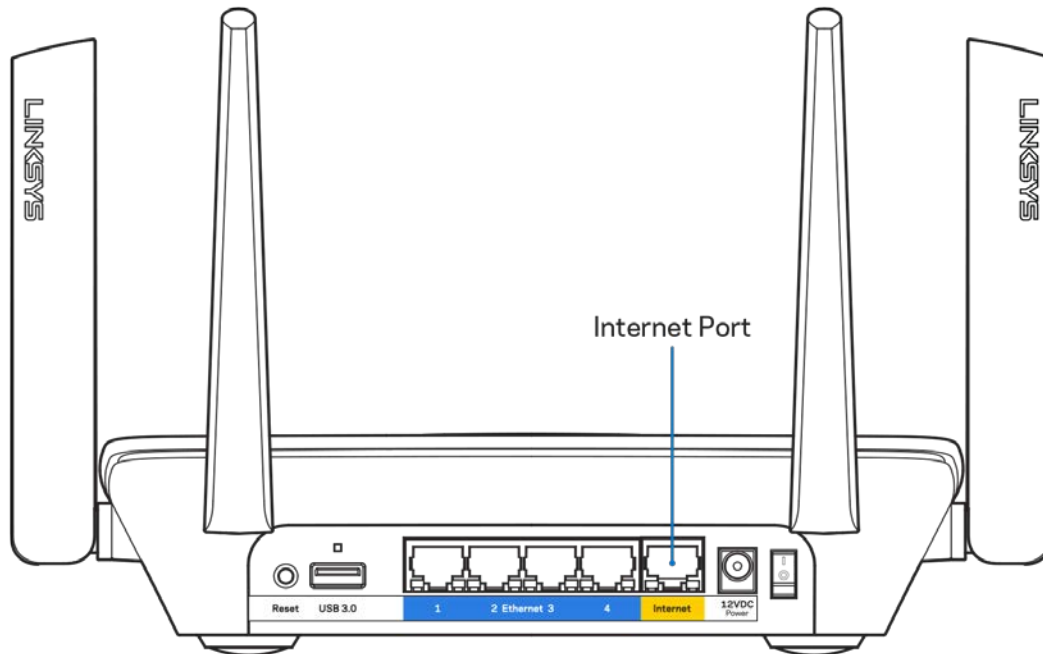

- Hãy đảm bảo rằng modem của bạn đã cắm nguồn và đã bật. Nếu bộ định tuyến có công tắc nguồn, hãy chắc chắn rằng công tắc đã ở vị trí ON (BẬT) hoặc | (trái ngược với O).

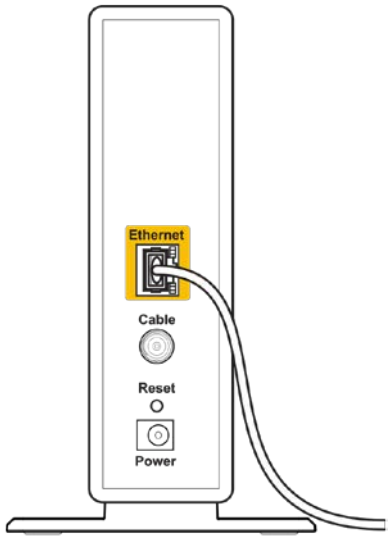
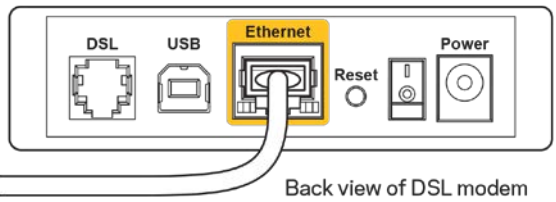
 <p>Back view of cable modem</p>	 <p>Back view of DSL modem</p>
<p>Nếu dịch vụ Internet của bạn là dịch vụ cáp, hãy kiểm tra và đảm bảo rằng cổng CABLE (CÁP) của modem cáp đã được kết nối với cáp đồng trục do ISP của bạn cung cấp.</p>	<p>Nếu dịch vụ Internet của bạn là dịch vụ DSL, hãy đảm bảo rằng đường dây điện thoại DSL đã được kết nối với của cổng DSL của modem.</p>

- Nếu trước đây, máy tính của bạn đã kết nối với modem bằng cáp USB, hãy rút cáp USB ra.
- Cài đặt lại bộ định tuyến.

## Thông báo Không thể truy nhập bộ định tuyến

Để truy nhập bộ định tuyến, bạn phải kết nối với mạng của riêng bạn. Nếu bạn có truy nhập Internet không dây, vấn đề có thể là do bạn đã vô tình kết nối với một mạng không dây khác.

Để khắc phục sự cố trên máy tính chạy Windows, hãy làm theo các bước sau\*:

1. Bấm vào biểu tượng không dây trên khay hệ thống. Danh sách các mạng hiện có sẽ xuất hiện.

2. Bấm vào tên mạng riêng của bạn. Bấm Connect (Kết nối). Trong ví dụ dưới đây, máy tính đã được kết nối vào một mạng không dây khác có tên wraith\_5GHz. Tên mạng không dây của bộ định tuyến Linksys EA8300, trong ví dụ này là Damaged\_Beez2.4, đã được chọn như minh họa.



3. Nếu bạn được nhắc nhập khóa bảo mật mạng, hãy nhập mật khẩu (khóa bảo mật) của bạn vào trường network security key (khóa bảo mật mạng). Bấm OK.
4. Máy tính của bạn sẽ kết nối vào mạng và bạn sẽ có thể truy cập bộ định tuyến.

\*Tùy thuộc vào phiên bản Windows của bạn mà có thể có một số sự khác nhau trong câu chữ hay các biểu tượng ở các bước này.

Để khắc phục sự cố trên máy tính Mac, hãy làm theo các bước sau:

1. Trên thanh menu ngang trên cùng màn hình, hãy bấm vào biểu tượng Wi-Fi. Danh sách các mạng không dây sẽ xuất hiện.
2. Trong ví dụ dưới đây, máy tính đã được kết nối vào một mạng không dây khác có tên wraith\_5GHz. Tên mạng không dây của bộ định tuyến Linksys EA8300, trong ví dụ này là Damaged\_Beez2.4, đã được chọn như minh họa.

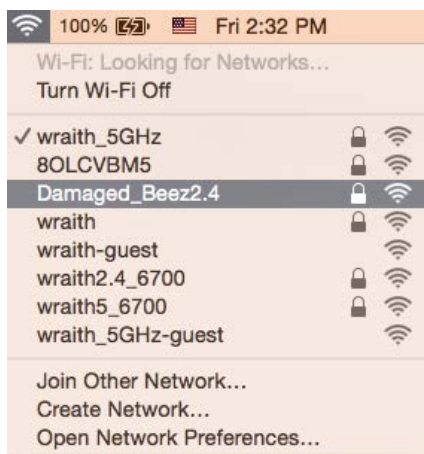

3. Bấm vào tên mạng không dây của bộ định tuyến Linksys EA8300 của bạn (trong ví dụ này là Damaged\_Beez2.4).
4. Nhập mật khẩu mạng không dây (Khoá Bảo mật) của bạn vào trường Password (Mật khẩu). Bấm OK.

## Sau khi thiết lập

### Mạng Internet không khả dụng

Nếu mạng Internet gặp khó khăn khi giao tiếp với bộ định tuyến của bạn thì vấn đề này có thể sẽ làm xuất hiện thông điệp “Không tìm thấy [địa chỉ Internet]” trong trình duyệt Web của bạn. Nếu bạn biết rằng địa chỉ Internet đó là chính xác và nếu bạn đã thử một vài địa chỉ Internet hợp lệ mà vẫn nhận kết quả tương tự thì thông điệp này có nghĩa là có sự cố với ISP của bạn hoặc với modem giao tiếp với bộ định tuyến của bạn. Hãy thử các cách sau:

- Hãy chắc chắn rằng cáp mạng và cáp nguồn đã được kết nối chắc chắn.
- Hãy chắc chắn rằng bộ định tuyến được cắm vào ổ cắm có điện.
- Khởi động lại bộ định tuyến.
- Liên hệ ISP của bạn và hỏi về tình hình ngừng dịch vụ trong khu vực của bạn.

Phương pháp phổ biến nhất để xử lý sự cố cho bộ định tuyến là tắt đi, rồi bật lại. Khi đó, bộ định tuyến có thể nạp lại các cài đặt tùy chỉnh của nó, và các thiết bị khác (ví dụ như modem) sẽ có thể phát hiện lại bộ định tuyến và giao tiếp với nó. Quy trình này gọi là khởi động lại.

Để khởi động lại bộ định tuyến của bạn bằng cách sử dụng dây nguồn, hãy làm theo các bước sau:

1. Ngắt kết nối dây nguồn khỏi bộ định tuyến và modem.
2. Đợi 10 giây và cắm lại dây nguồn vào modem. Hãy chắc chắn rằng nó có điện.
3. Đợi đến khi đèn báo trực tuyến của modem dừng nhấp nháy (khoảng hai phút). Cắm lại dây điện vào bộ định tuyến.
4. Đợi đến khi logo Linksys bật sáng. Đợi hai phút trước khi thử kết nối Internet từ một máy tính.

Để khởi động lại bộ định tuyến của bạn bằng cách sử dụng Linksys Smart Wi-Fi, hãy làm theo các bước sau:

1. Đăng nhập Linksys Smart Wi-Fi. (Xem "Cách kết nối với Linksys Smart Wi-Fi" trên trang [11](#)).
2. Dưới *Router Settings* (Cài đặt Bộ định tuyến), bấm *Troubleshooting* (Xử lý sự cố).
3. Bấm thẻ *Diagnostics* (Chẩn đoán).
4. Dưới *Reboot* (Khởi động lại), bấm **Reboot** (Khởi động lại).



5. Bấm Yes (Có). Bộ định tuyến sẽ khởi động lại. Khi bộ định tuyến đang khởi động lại, tất cả thiết bị đang kết nối sẽ mất kết nối Internet và sẽ tự động kết nối lại khi bộ định tuyến sẵn sàng trở lại.

### Linksys Smart Wi-Fi không mở trong trình duyệt web của bạn

Phiên bản mới nhất của Google Chrome™, Firefox®, Safari® (đối với Mac® và iPad®), Microsoft Edge và Internet Explorer® phiên bản 8 trở lên đều tương thích với Linksys Smart Wi-Fi.



# Thông số kỹ thuật

## Linksys EA8300

Tên sản phẩm	Bộ định tuyến ba băng tần Max-Stream AC2200 MU-MIMO
Mã sản phẩm	EA8300
Tốc độ Cổng Thiết bị chuyển mạch	10/100/1000 Mbps (Gigabit Ethernet)
Tần số vô tuyến	2.4 GHz và 5 GHz (x2)
Số lượng ăng-ten	4 ăng-ten ngoài có thể điều chỉnh (không thể tháo rời)
Cổng	USB 3.0, Ethernet (1-4), Internet, Nguồn
Nút	Wi-Fi Protected Setup, Nguồn, Reset (Đặt lại)
Đèn	Mặt trên: Logo Linksys phát sáng, Wi-Fi Protected Setup, Kết nối Internet, Kết nối cáp mạng tới cổng Internet Mặt sau: USB, Ethernet (1-4), Internet
UPnP	Có hỗ trợ
Tính năng bảo mật	WEP, WPA2, RADIUS
Bit mã khóa bảo mật	Mã hóa tối đa 128-bit
Hỗ trợ hệ thống tệp lưu trữ	FAT, NTFS và HFS+
Hỗ trợ Trình duyệt	Phiên bản mới nhất của Google Chrome™, Firefox®, Safari® (đối với Mac® và iPad®), Microsoft Edge và Internet Explorer® phiên bản 8 trở lên

## Môi trường

Kích thước	213,7mm x 161,8mm x 54,8mm (không tính ăng-ten)
Trọng lượng thiết bị	608 g
Nguồn	12V, 2A
Chứng chỉ	FCC, IC, CE, Wi-Fi (a/b/g/n/ac)
Nhiệt độ hoạt động	32 đến 104°F (0 đến 40°C)
Nhiệt độ bảo quản	-4 đến 140°F (-20 đến 60°C)
Độ ẩm hoạt động	10% đến 80% độ ẩm tương đối, không ngưng tụ
Độ ẩm bảo quản	5% đến 90% không ngưng tụ

Các thông số kỹ thuật có thể thay đổi mà không cần thông báo.

Lưu ý:

Để biết thông tin quy định, bảo hành và an toàn, hãy xem CD đi kèm với bộ định tuyến hoặc truy cập [Linksys.com/support/EA8300](http://Linksys.com/support/EA8300).

Hiệu suất tối đa lấy từ các thông số kỹ thuật của Tiêu chuẩn IEEE 802.11. Hiệu suất thực tế có thể thay đổi, trong đó công suất của mạng không dây, tốc độ truyền dữ liệu, phạm vi và vùng phủ sóng có thể thấp hơn. Hiệu suất phụ thuộc vào nhiều yếu tố, điều kiện và biến số như: khoảng cách tới điểm truy nhập, lưu lượng mạng, vật liệu và cấu trúc xây dựng, hệ điều hành sử dụng, kết hợp nhiều sản phẩm không dây, nhiễu và các điều kiện bất lợi khác.

BELKIN, LINKSYS và nhiều tên sản phẩm và logo là thương hiệu của tập đoàn các công ty Belkin. Các thương hiệu của bên thứ ba được đề cập là tài sản của chủ sở hữu tương ứng. Các giấy phép và thông báo cho các phần mềm của bên thứ ba được sử dụng trong sản phẩm này có thể xem ở đây: <http://support.linksys.com/en-us/license>. Vui lòng liên hệ <http://support.linksys.com/en-us/gplcodecenter> nếu có câu hỏi hoặc yêu cầu mã nguồn GPL.

© 2017 Belkin International, Inc. và/hoặc các công ty con. Bảo lưu mọi quyền.

LNKPG-00459 Rev. A00