

**SAMSUNG**

SM-R210

# User Manual

# Table of Contents

## Basics

- 3 About the Gear 360
- 4 Read me first
- 5 Package contents
- 6 Device layout
- 8 Indicator light
- 9 Camera status screen
- 11 Memory card
- 14 Battery
- 17 Attaching the strap to the Gear 360
- 18 Turning the Gear 360 on and off
- 19 Connecting the Gear 360 to a mobile device

## Appendix

- 50 Troubleshooting
- 52 Removing the battery

## Using the Gear 360

- 23 Using the Gear 360's menus
- 24 Recording videos and taking photos with the Gear 360 solely
- 25 Connecting to a mobile device remotely
- 26 Recording videos or taking photos
- 36 Live Broadcast
- 37 Configuring camera settings
- 39 Viewing videos or images
- 46 Using the computer program
- 47 Transferring files to a computer
- 47 Configuring the settings
- 49 Updating the software

# Basics

## About the Gear 360

The Gear 360 camera captures 360-degree videos and photos of you and your surroundings in one shot. The two fisheye lenses capture lively photos and videos.

When you connect the Gear 360 to your mobile device via Bluetooth or Wi-Fi, you can capture videos and photos remotely from your mobile device. You can also view, edit, and share videos and photos.

If you connect the Gear 360 to a Gear VR, you can view your Gear 360 videos more realistically.



## Read me first

Please read this manual before using this device to ensure safe and proper use.

- Images may differ in appearance from the actual product. Content is subject to change without prior notice.
- Before using the Gear 360 make sure they are compatible with your device.
- This product includes certain free/open source software. To see the instructions for viewing the open source licence, go to the Samsung website ([opensource.samsung.com](https://opensource.samsung.com)).

### Instructional icons



**Warning:** situations that could cause injury to yourself or others



**Caution:** situations that could cause damage to your device or other equipment



**Notice:** notes, usage tips, or additional information

## Package contents

Check the product box for the following items:

- Gear 360
- USB Cable (USB Type-C)
- Strap
- Pouch
- Quick start guide



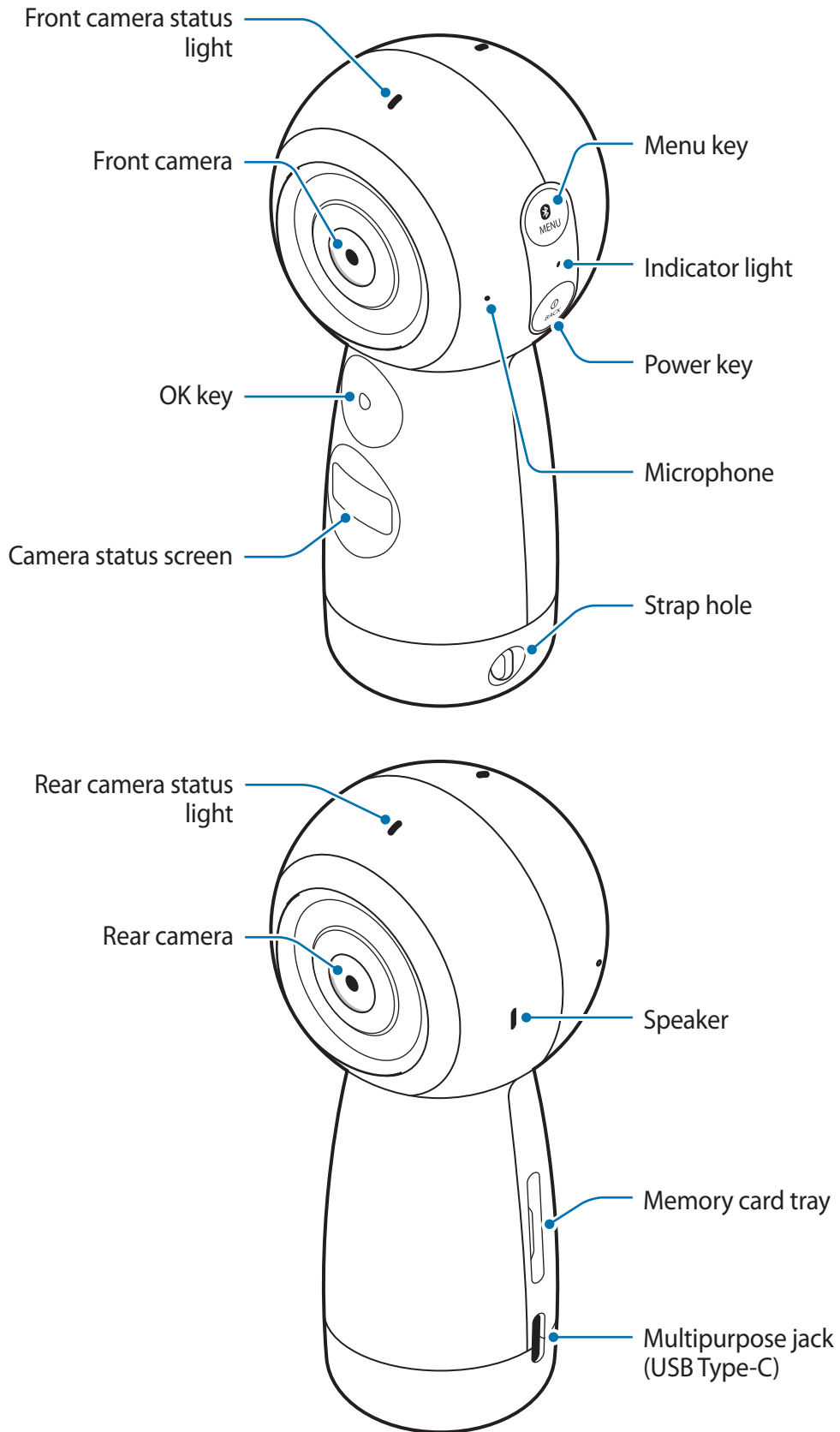

- The items supplied with the Gear 360 and any available accessories may vary depending on the region or service provider.
- The supplied items are designed only for this Gear 360 and may not be compatible with other devices.
- Appearances and specifications are subject to change without prior notice.
- You can purchase additional accessories from your local Samsung retailer. Make sure they are compatible with the Gear 360 before purchase.
- Use only Samsung-approved accessories. Using unapproved accessories may cause the performance problems and malfunctions that are not covered by the warranty.
- Availability of all accessories is subject to change depending entirely on manufacturing companies. For more information about available accessories, refer to the Samsung website.
- Always store the Gear 360 in its pouch. If its lenses are scratched, image quality may decrease.

# Device layout

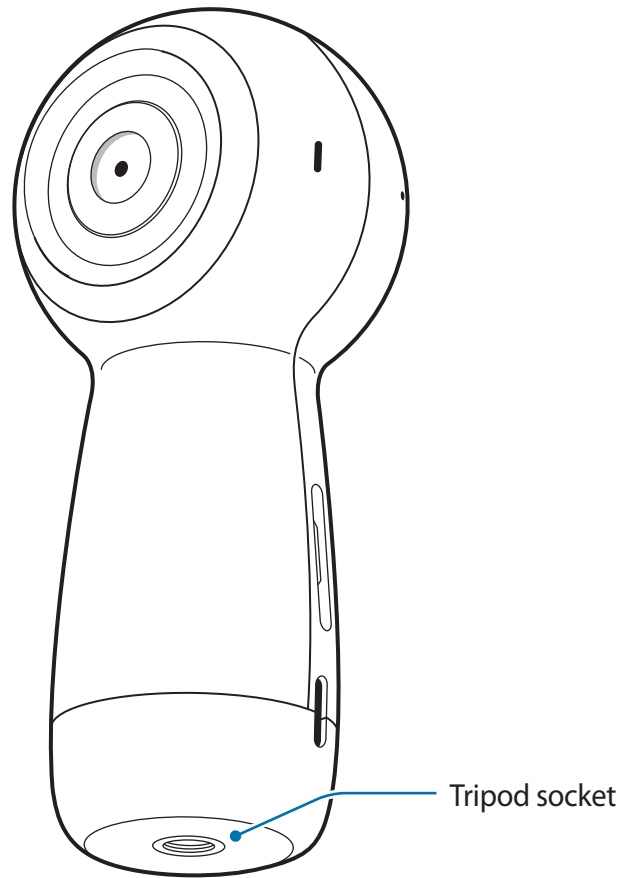



## Keys

| Key  | Function  |
|--|---|
|  <b>Power</b> | <ul style="list-style-type: none"> <li>• Press and hold to turn the Gear 360 on or off.</li> <li>• Press to return to the previous screen on the camera status screen.</li> </ul> |
|  <b>Menu</b>  | <ul style="list-style-type: none"> <li>• Press repeatedly to move to the menu you want.</li> <li>• Press and hold to access connection modes.</li> </ul>                          |
|  <b>OK</b>    | <ul style="list-style-type: none"> <li>• Press to record a video or take a photo, or select the option you want.</li> </ul>   |

## Indicator light

The indicator light informs you of your Gear 360's status.

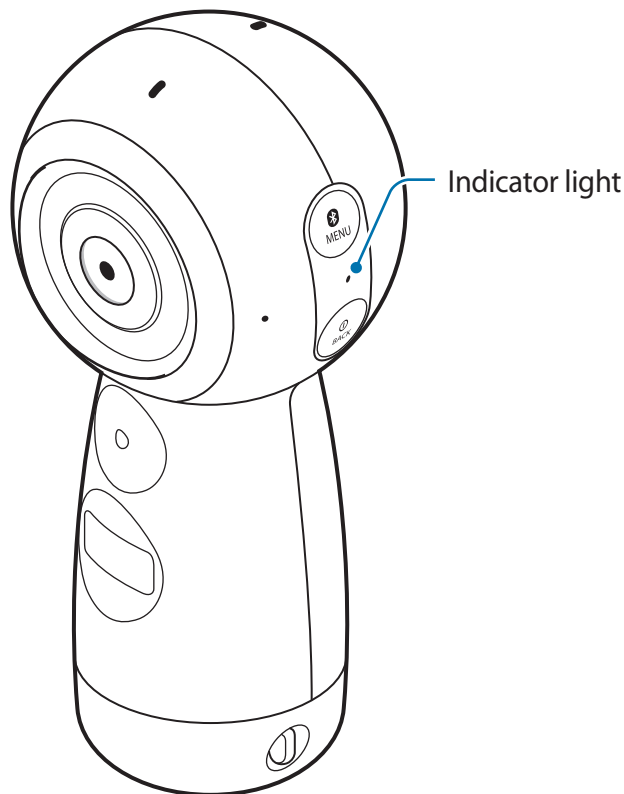

| Colour                   | Status  |
|--------------------------|---|
| Flashes blue three times | <ul style="list-style-type: none"> <li>• Power on</li> <li>• Formatting a memory card or successfully resetting the Gear 360</li> </ul> |
| Flashes red three times  | <ul style="list-style-type: none"> <li>• Power off</li> </ul>   |
| Flashes red              | <ul style="list-style-type: none"> <li>• Battery power is low (lower than 10 %)</li> <li>• Overheating</li> </ul>                       |
| Red                      | <ul style="list-style-type: none"> <li>• The battery is charging.</li> </ul>  |
| Green                    | <ul style="list-style-type: none"> <li>• The battery is fully charged.</li> </ul>   |
| Red → Green → Blue       | <ul style="list-style-type: none"> <li>• Waiting for the mobile device to connect</li> </ul>  |
| Blue                     | <ul style="list-style-type: none"> <li>• Connected to the mobile device</li> </ul>  |
| Flashes blue             | <ul style="list-style-type: none"> <li>• Transferring videos or photos</li> <li>• Updating software</li> </ul>                          |



## Camera status screen



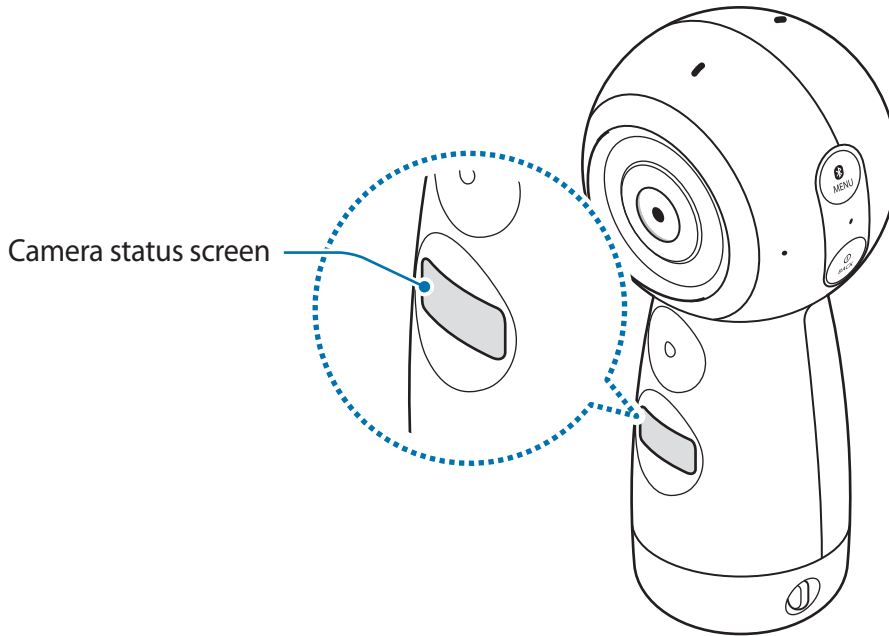





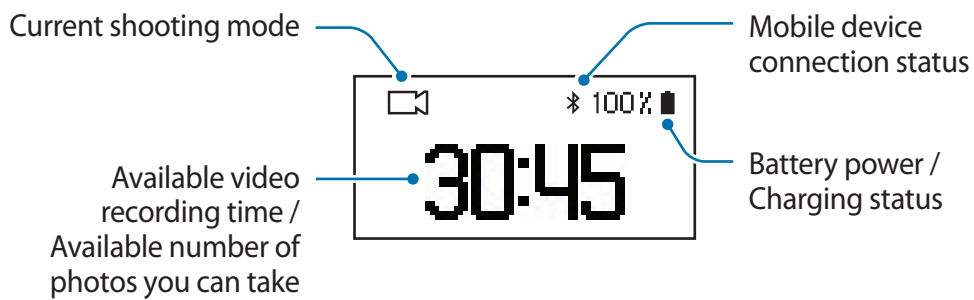





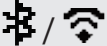





Access menus, such as camera modes and connection modes, and view the Gear 360's status via messages and indicator icons on the camera status screen.



## Indicator icons

Indicator icons appear on the camera status screen. You can check the Gear 360's status on the camera status screen.



| Icon  | Meaning   |
|---|---|
|    | Battery power level   |
|    | Battery charging status <ul style="list-style-type: none"> <li>•  : Charging</li> <li>•  : Overheating</li> <li>•  : Charger connected improperly</li> </ul> |
|    | Connected to a mobile device  |
|    | Waiting for the mobile device to connect  |
|    | Not connected to a mobile device  |
|    | Recording mode  |
|    | Recording a video   |
|    | Photo shooting mode   |
|   | Time lapse mode<br>Take several photos at set intervals and save them as one video.   |
| 0.5s  | Time lapse shooting interval  |
|  | Recording a time lapse video  |
|  | Video looping mode<br>Record a video continuously by deleting a set period of the previously recorded content and saving the new content.   |
| 5m  | Video looping recording time  |
|  | Landscape HDR mode<br>Automatically take three photos, combine them, and then calibrate the colours.  |
|  | Live broadcast mode   |
|  | Broadcasting a live video   |
|  | Memory card is full   |
|  | No memory card  |
|  | Memory card error   |
|  | Connected to a computer with a USB cable  |
|  | USB connection error  |

# Memory card

## Installing a memory card

A memory card must be inserted to record videos or take photos. Depending on the memory card manufacturer and type, some memory cards may not be compatible with your Gear 360.



- Some memory cards may not be fully compatible with the Gear 360. Using an incompatible card may damage the Gear 360 or the memory card, or corrupt the data stored in it.
- If you use a slow writing memory card, the recording of your video can be interrupted because the card cannot process data at the rate the video is being shot. If this occurs, replace the card with a faster memory card or reduce the video resolution.
- Use caution to insert the memory card right-side up.



- Memory cards are sold separately.
- If you insert or remove a memory card while the Gear 360 is turned on, the power will turn off.
- Frequent writing and erasing of data shortens the lifespan of memory cards.
- When a memory card is not inserted, **Check SD Card** is displayed on the camera status screen.

- 1 Pull out the memory card tray gently from the memory card tray slot.

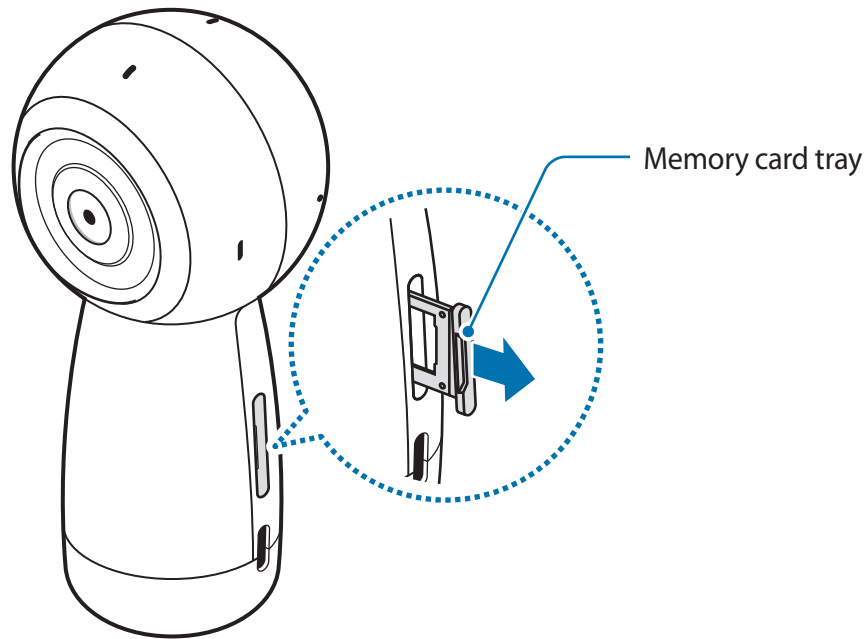

Be careful not to damage your fingernails when you remove the memory card tray.

- 2 Gently press the memory card into the memory card tray with the gold-coloured contacts properly aligned with the Gear 360's contacts.
- 3 Insert the memory card tray back into the memory card tray slot.

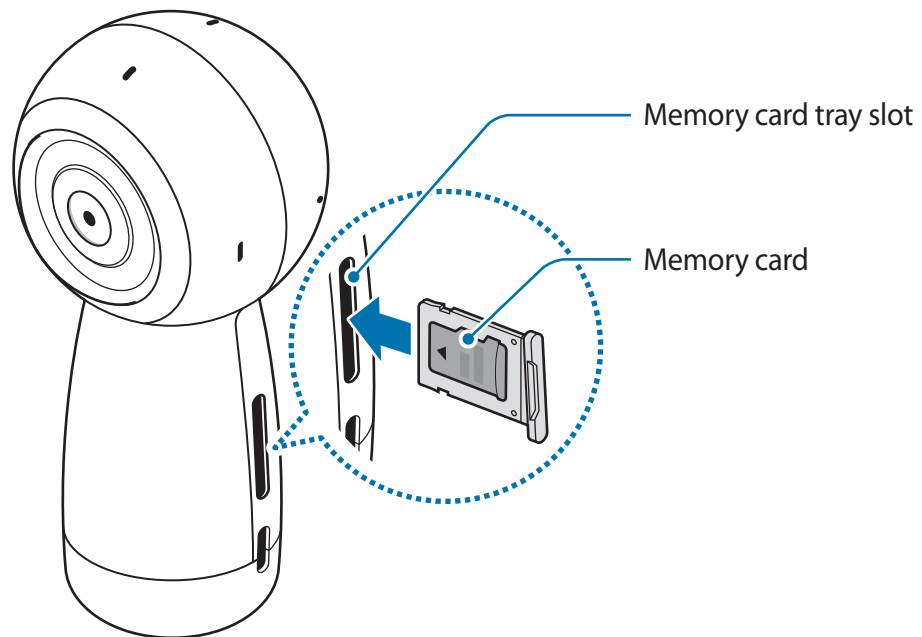

## Removing the memory card

- 1 Pull out the memory card tray gently from the memory card tray slot.
- 2 Remove the memory card.
- 3 Insert the memory card tray back into the memory card tray slot.

## Formatting the memory card

A memory card formatted on a computer may not be compatible with the Gear 360. Format the memory card on the Gear 360 or on the mobile device.



Before formatting the memory card, remember to make backup copies of all important data stored in the memory card. The manufacturer's warranty does not cover loss of data resulting from user actions.

## Formatting on the Gear 360

- 1 Press the Menu key until **Settings** appears on the camera status screen, and then press the OK key to select it.
- 2 Press the Menu key until **Format** appears on the camera status screen, and then press the OK key to select it.
- 3 Press the Menu key until **Yes** appears on the camera status screen, and then press the OK key to select it.

A confirmation message will appear on the camera status screen when the formatting is finished.

## Formatting on the mobile device

1 On the mobile device, tap the **Samsung Gear 360** app or the **Gear 360** app → **Settings**.

2 Tap **Reset and format** → **Format Gear 360 SD card**.

A confirmation message will appear on the camera status screen when the formatting is finished.



If you want to format a memory card on the mobile device, you must connect the Gear 360 to the mobile device. Refer to [Connecting the Gear 360 to a mobile device](#) for more information.

## Battery

### Charging the battery

Charge the battery before using the Gear 360 for the first time or when it has been unused for extended periods.



Use only Samsung-approved chargers. Unapproved chargers can cause the battery to explode or damage the Gear 360.



Connecting the charger improperly may cause serious damage to the device. Any damage caused by misuse is not covered by the warranty.



- Chargers are sold separately.
- To save energy, unplug the charger when not in use. The charger does not have a power switch, so you must unplug the charger from the electric socket when not in use to avoid wasting power. The charger should remain close to the electric socket and easily accessible while charging.

- 1 Plug the small end of the charger into the multipurpose jack of the Gear 360, and plug the large end of the charger into an electric socket.

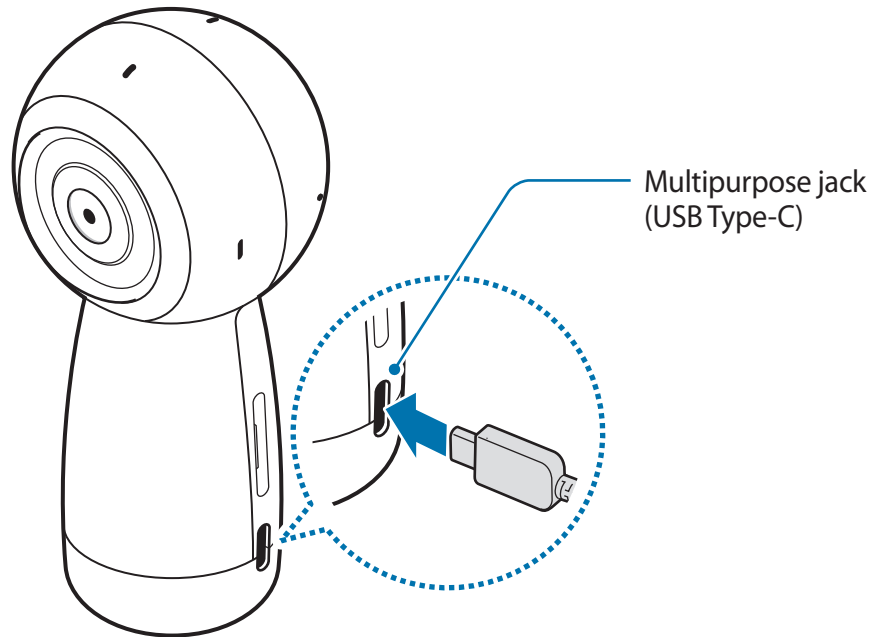

- 2 After fully charging, disconnect the Gear 360 from the charger. First unplug the charger from the Gear 360, and then unplug it from the electric socket.

## Battery charging tips and precautions

- When the battery power is low, the battery icon appears empty.
- If the battery is completely discharged, the device cannot be turned on immediately when the charger is connected. Allow a depleted battery to charge for a few minutes before turning on the device.
- Using a power source other than the charger, such as a computer, may result in a slower charging speed due to a lower electric current.
- The device can be used while it is charging, but it may take longer to fully charge the battery.
- While charging, the Gear 360 and the charger may heat up. This is normal and should not affect the Gear 360's lifespan or performance. If the temperature rises above a certain level, battery charging will be stopped.
- You cannot charge the Gear 360 while recording a video, using the time lapse feature, or using the viewfinder remotely on the connected mobile device.
- To save the battery power, activate the auto shut-off feature.
- When you do not use the auto shut-off feature, the battery will be charged only when the Gear 360 is turned off.
- If the Gear 360 is not charging properly, take the Gear 360 and the charger to a Samsung Service Centre.



## Attaching the strap to the Gear 360

You can conveniently carry the Gear 360 by attaching the strap to the Gear 360. Insert the strap into the strap hole, and then pull the loop.

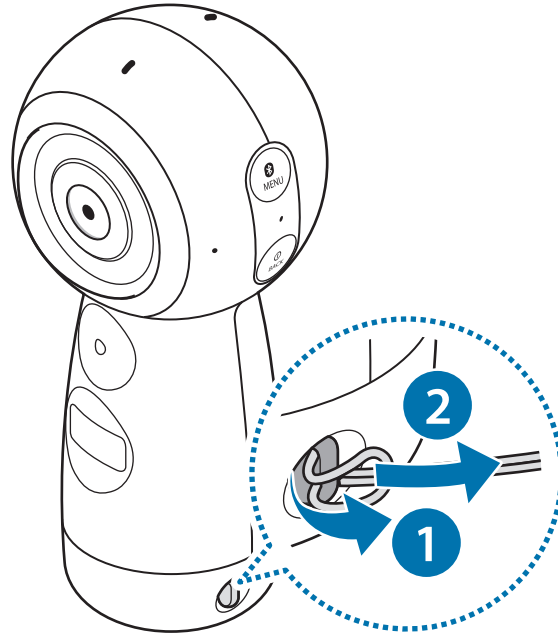

You can also use the strap's rubber ring to fix the Gear 360 to record videos or take photos.

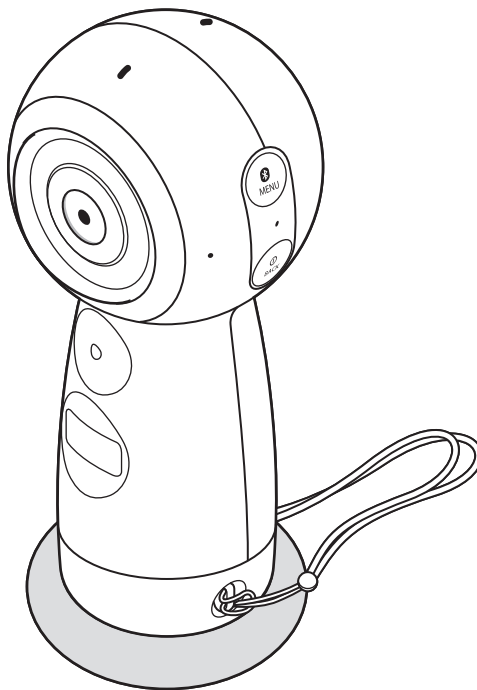

## Turning the Gear 360 on and off

Press and hold the Power key to turn on the Gear 360.

To turn off the Gear 360, press and hold the Power key.

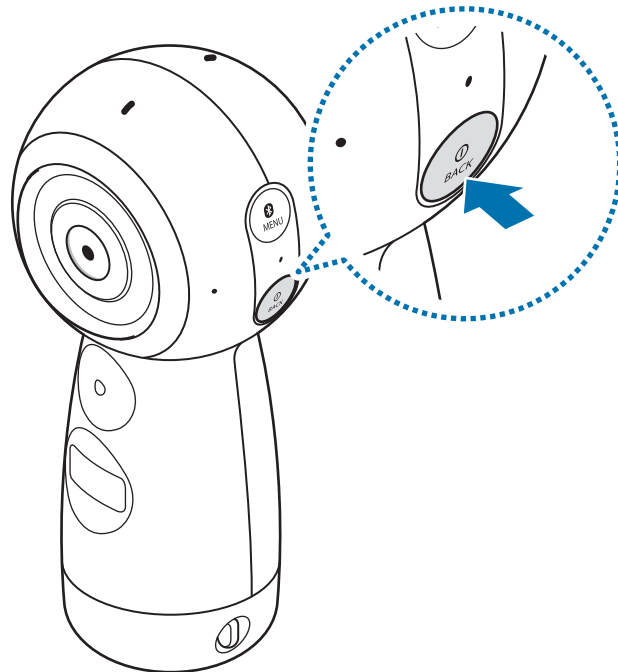

- The Gear 360 turns off if it is not used for a specified period. By using the **Auto power off after** option, you can set the length of time the Gear 360 waits before it turns off. Refer to [Configuring the settings](#) for more information.
- Follow all posted warnings and directions from authorised personnel in areas, such as aeroplanes and hospitals.

### Restarting the Gear 360

If your Gear 360 is frozen and unresponsive, press and hold the Power key for more than 7 seconds to restart it.

# Connecting the Gear 360 to a mobile device

## Installing the app on a mobile device

To connect your Gear 360 and mobile device, install the Samsung Gear 360 app or the Gear 360 app on the mobile device.

Download the Samsung Gear 360 (New) app from **Galaxy Apps** or **Play Store**.

For iOS devices, download the Samsung Gear 360 app from **App Store**.



Depending on your mobile device, it may not be compatible with the Gear 360 or may not support some features. Visit [www.samsung.com](http://www.samsung.com) to see a list of compatible mobile devices.

## Connecting to a mobile device

To control the Gear 360 from your mobile device, the Gear 360 must be paired with the mobile device. After the Gear 360 has paired with the mobile device, the Gear 360 will try to connect to the mobile device every time you turn on the Gear 360.

For Android devices, you can capture videos and photos and view them on your mobile device via Wi-Fi Direct after connecting for the first time.



Connection methods may vary depending on your mobile device and software version. To connect with an iOS device, connect the Gear 360 with the mobile device in the Wi-Fi settings, launch the Gear 360 app, and then complete the connection.

### **Gear 360**

- 1 Turn on the Gear 360.
- 2 Press and hold the Menu key.

- 3 When **Connect to Android** appears on the camera status screen, press the OK key.  
For iOS devices, press the Menu key again, and when **Connect to iOS** appears on the camera status screen, press the OK key.



If you connect the Gear 360 to your iOS mobile device via Wi-Fi, iOS mobile device pairing mode (Wi-Fi) will be activated automatically from next time without having to press the Menu key. Also, Connect to iOS appears on the camera status screen first when you press and hold the Menu key.

### Mobile device

- 4 Launch the **Samsung Gear 360** app on the mobile device.  
For iOS devices, launch the **Gear 360** app.
- 5 Tap **CONNECT TO GEAR 360**.

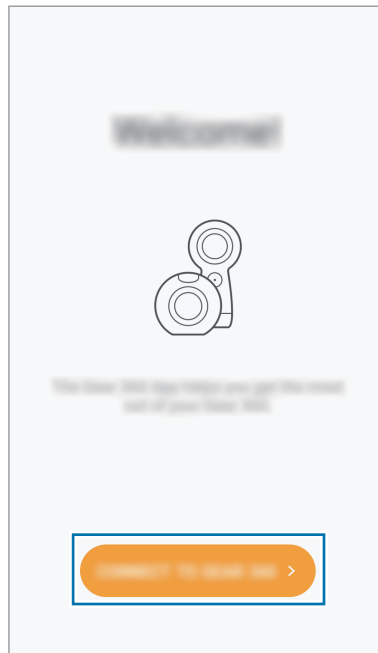

- 6 Follow the on-screen instructions to complete the connection.  
When your Gear 360 and mobile device are connected, the Bluetooth or Wi-Fi icon will appear on the camera status screen.

## Disconnecting or reconnecting the Gear 360

On the mobile device, tap the **Samsung Gear 360** app → ⋮ → **Disconnect**. The Gear 360 will be disconnected from the mobile device.

To reconnect the Gear 360, tap **CONNECT** on the Samsung Gear 360 app screen of the mobile device.

## Connecting a new Gear 360

After you unpair the Gear 360 from your mobile device, you can connect another Gear 360.

On your mobile device, tap **Samsung Gear 360** → ⋮ → **Connect to new Gear 360**.

## Notices for using Bluetooth

Bluetooth is a wireless technology standard that uses a 2.4 GHz frequency to connect to various devices over short distances. It can connect and exchange data with other Bluetooth enabled devices, such as mobile devices, without connecting via cables.

- To avoid problems when connecting your Gear 360 to another device, place the devices close to each other.
- Ensure that your Gear 360 and the other Bluetooth device are within the Bluetooth connection range (10 m). The distance may vary depending on the environment the devices are used in.
- Ensure that there are no obstacles between the Gear 360 and a connected device, including human bodies, walls, corners, or fences.
- Do not touch the Bluetooth antenna of a connected device.
- Bluetooth uses the same frequency as some industrial, scientific, medical, and low power products and interference may occur when making connections near these types of products.
- Some devices, especially those that are not tested or approved by the Bluetooth SIG, may be incompatible with the Gear 360.
- Do not use the Bluetooth feature for illegal purposes (for example, pirating copies of files or illegally tapping communications for commercial purposes).

## Notices for using Wi-Fi

- Use your Gear 360 and the connected device within the specified connection range (5 m). The distance may vary depending on the environment the devices are used in.
- Ensure that there are no obstacles between the Gear 360 and a connected device, including human bodies, walls, corners, or fences.
- If a mobile device connects to the Gear 360 via Wi-Fi Direct while it is connected to a Wi-Fi network, the mobile device's screen may flicker due to the limited capability of the Wi-Fi network.
- Using a mobile device near other devices which are connected to the Wi-Fi network may affect the signal strength and cause the screen to flicker.
- Wi-Fi performance may vary depending on the region. If you connect the Gear 360 to your mobile device in a place where outdoor Wi-Fi networks are restricted, the device may become slower or take longer to send files.
- The transfer time may take longer depending on the Wi-Fi connection status and file size.

# Using the Gear 360

## Using the Gear 360's menus

Select menus that appear on the camera status screen by pressing the keys on the Gear 360.

### Accessing and selecting menus

- 1 Press, or press and hold, the Menu key.
- 2 Press the Menu key until the menu you want appears.
- 3 Press the OK key to select the menu.  
To undo the selection or return to the previous menu, press the Power key.

### Available menus

#### When pressing the Menu key:

- **Video:** Recording mode. Refer to [Recording videos](#) for more information.
- **Photo:** Photo shooting mode. Refer to [Taking photos](#) for more information.
- **Time lapse:** Time lapse mode. Refer to [Time lapse](#) for more information.
- **Video looping:** Video looping mode. Refer to [Video looping](#) for more information.
- **Landscape HDR:** Landscape HDR mode. Refer to [Landscape HDR](#) for more information.
- **Settings:** Customise settings. Refer to [Configuring the settings](#) for more information.

#### When pressing and holding the Menu key:

- **Connect to Android:** Enter pairing mode for an Android mobile device.
- **Connect to iOS:** Enter pairing mode for an iOS mobile device.
- **Connect to remote:** Enter remote control mode. A remote control is sold separately.

## Recording videos and taking photos with the Gear 360 solely

You can use the Gear 360 to record videos and take photos without connecting to any other devices.

- 1 Press the Menu key to select a shooting mode and press the OK key.
- 2 Press the OK key to record a video or take a photo.  
To stop recording a video, press the OK key.

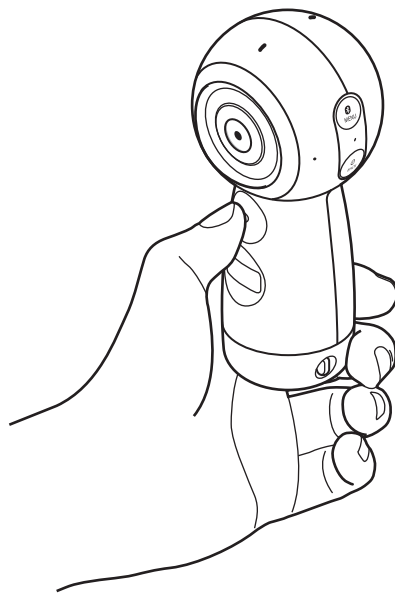



## Connecting to a mobile device remotely

When the Gear 360 and your mobile device are remotely connected, you can record videos and take photos using the mobile device as a viewfinder. You can also view the videos and images captured by the Gear 360 on the mobile device.

Launch the **Samsung Gear 360** app or the **Gear 360** app on your mobile device, and then tap **Camera** to activate the remote viewfinder. Or, tap **Gallery** to access the videos and images saved in the Gear 360.

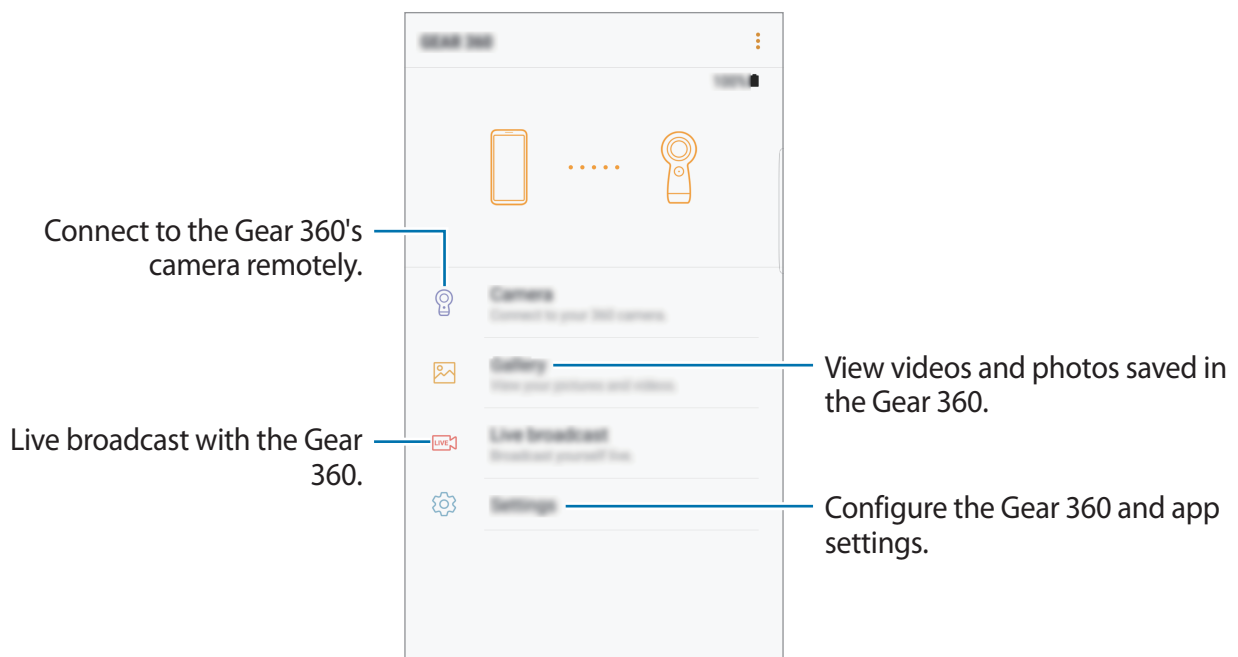

For Android devices, the mobile device's Wi-Fi feature will be activated automatically and the Gear 360 is connected with your mobile device via Wi-Fi Direct.



The screen and some features may be different depending on the mobile device or software version.

# Recording videos or taking photos

## Introduction

Record videos and take photos directly from the Gear 360 using the front and rear cameras. When the Gear 360 is connected to your mobile device, you can capture videos and photos remotely using the mobile device as a viewfinder.



- A memory card must be inserted into the Gear 360 to record videos or take photos.
- Due to the camera lens' structure, blind spots may occur on captured videos and images. When capturing videos and photos using both the front and rear cameras, the border where two images are stitched together may not be smooth.

## Camera etiquette

- Do not record videos or take photos of other people without their permission.
- Do not record videos or take photos where legally prohibited.
- Do not record videos or take photos in places where you may violate other people's privacy.





## Tips for getting the best shots

- Place the subject in the centre of the frame of the camera's front and rear lenses.
- In dual lens mode, the border where two images are stitched together will be more natural when you keep a suitable distance from the subject.
- Make sure that the lenses are clean and avoid touching the lenses while capturing videos and images.

## Selecting a camera

Select a camera to use. The selected camera's status light will turn green.

### Using the mobile device

- 1 Launch the **Samsung Gear 360** app on the mobile device.  
For iOS devices, launch the **Gear 360** app.
- 2 Tap **Camera**.  
The viewfinder will appear.
- 3 Tap  and select a camera.
  -  **Dual**: Use both the front and rear cameras simultaneously to capture 360-degree videos or photos.
  -  **Front**: Use the front camera to capture wide-angle videos or photos.
  -  **Rear**: Use the rear camera to capture wide-angle videos or photos.

### Using the Gear 360

- 1 Press the Menu key until **Settings** appears on the camera status screen, and then press the OK key to select it.
- 2 Press the Menu key until **Switch lens** appears on the camera status screen, and then press the OK key to select it.
- 3 Press the Menu key until the camera you want to use appears on the camera status screen, and then press the OK key to select it.
  - **Dual lens**: Use both the front and rear cameras simultaneously to capture 360-degree videos or photos.
  - **Single lens Front**: Use the front camera to capture wide-angle videos or photos.
  - **Single lens Rear**: Use the rear camera to capture wide-angle videos or photos.

## Recording videos

Record 360-degree videos in dual lens mode, or record wide-angle videos in single lens mode.

 When recording videos or using the streaming feature for an extended period, the Gear 360 may heat up. If the temperature rises above a certain level, the Gear 360 will stop recording and turn off automatically to prevent damage. If the Gear 360 is turned off due to overheating, wait for it to cool down before resuming use.

-  iOS devices do not support the preview feature when recording videos.
- Large files will be divided into 1.8 GB units and saved.

## Using the mobile device

1 Launch the **Samsung Gear 360** app on the mobile device.  
For iOS devices, launch the **Gear 360** app.

2 Tap **Camera**.  
The viewfinder will appear.

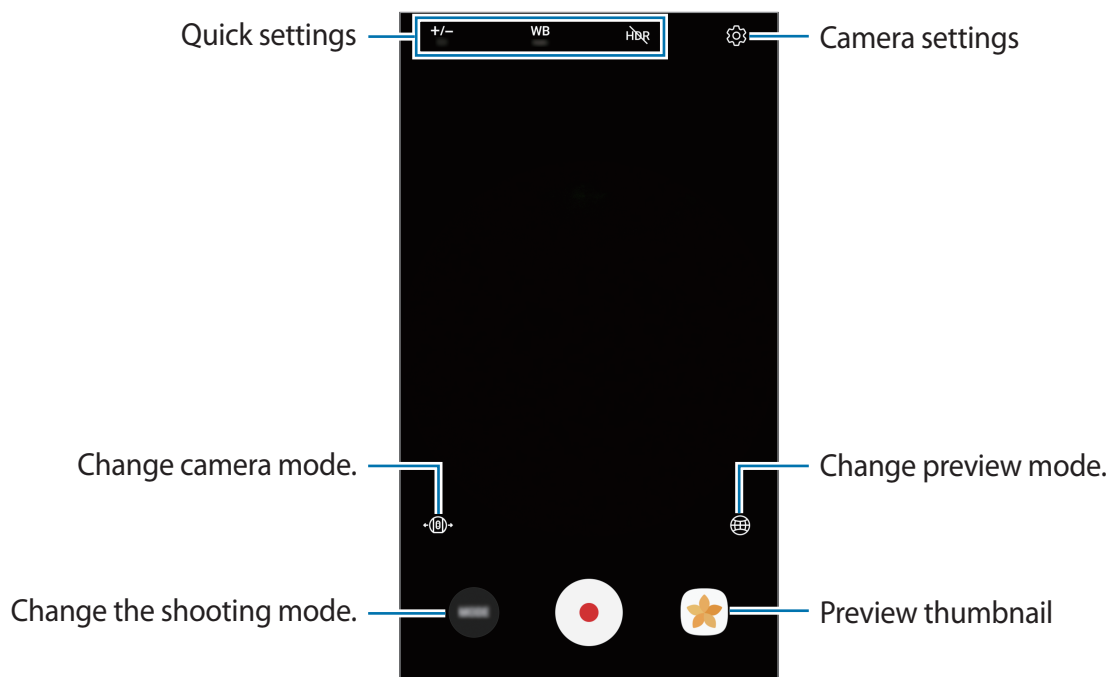

3 Tap **MODE** → **Video**.

4 Point the camera at a subject and tap  to record a video.  
While recording, the camera status light will flash red.

5 Tap  to finish recording the video.  
The video will be saved in the Gear 360's memory card.







The available video recording time will be displayed on the camera status screen.

### Changing preview mode

In dual lens mode, you can preview images that will be taken with the front and rear cameras in different forms by changing preview mode.

On the viewfinder, tap  to change preview mode.

-  **360° view**: Display the preview image spherically.
-  **Round view**: Display the preview image as an inverted panorama.
-  **Stretched view**: Display the preview image with a stretched view.
-  **Dual view**: Split the preview image to display each of the front and rear cameras' screens.
-  **Panoramic view**: Display the preview image with a wide view.



In the 360° view, Round view, and Stretched view modes, you can view images from different angles by dragging your finger across the screen in any direction. To reset the angle to the default setting, tap **Reset view**.

## Using the Gear 360

- 1 Press the Menu key until **Video** appears on the camera status screen, and then press the OK key to select it.
- 2 Press the OK key to record a video.  
While recording, the camera status light will flash red and the recording time will appear on the camera status screen.
- 3 Press the OK key to finish recording the video.  
The video will be saved in the Gear 360's memory card.



The available video recording time will be displayed on the camera status screen.

## Taking photos

Take 360-degree photos in dual lens mode, or take wide-angle photos in single lens mode.

## Using the mobile device

- 1 Launch the **Samsung Gear 360** app on the mobile device.  
For iOS devices, launch the **Gear 360** app.
- 2 Tap **Camera**.  
The viewfinder will appear.
- 3 Tap **MODE** → **Photo**.
- 4 Point the camera at a subject and tap  to take a photo.  
The photo will be saved in the Gear 360's memory card.



The available number of photos you can take will be shown on the camera status screen.

## Using the Gear 360

1 Press the Menu key until **Photo** appears and then press the OK key to select it.

2 Press the OK key to take a photo.

The photo will be saved in the Gear 360's memory card.



- The available number of photos you can take will be shown on the camera status screen.
- Depending on the shooting conditions, the total number of remaining photos may not appear to decrease after taking photos.

## Time lapse

Take several photos at set intervals and save them as one video. By playing the videos, you can view how the subject looks different from various perspectives.



You cannot preview the images while recording the time lapse videos.

## Using the mobile device

1 Launch the **Samsung Gear 360** app on the mobile device.

For iOS devices, launch the **Gear 360** app.

2 Tap **Camera**.

The viewfinder will appear.

3 Tap **MODE** → **Time lapse**.

4 Tap  to set intervals.

5 Tap  to record a video.

6 Tap  to finish recording the video.

The video will be saved in the Gear 360's memory card.

## Using the Gear 360

- 1 Press the Menu key until **Time lapse** appears on the camera status screen, and then press the OK key to select it.

The recording intervals will appear on the camera status screen.



To change the recording intervals, select **Settings** → **Mode settings** → **Time lapse Video interval** on the Gear 360 or tap  on the connected mobile device's viewfinder.

- 2 Press the OK key to record videos.
- 3 Press the OK key to finish recording videos.

The video will be saved in the Gear 360's memory card.

## Video looping

Record a video continuously by deleting a set period of the previously recorded content and saving the new content. You can make the most of the memory card's capacity.



iOS devices do not support the preview feature.

## Selecting the recording cycle

- 1 Launch the **Samsung Gear 360** app on the mobile device.  
For iOS devices, launch the **Gear 360** app.

- 2 Tap **Camera**.  
The viewfinder will appear.



3 Tap **MODE** → **Video looping**.

4 Tap  and select a recording cycle.

- **5 minutes:** Record a video for 5 minutes and save the video at 1-minute intervals. The beginning of the previously recorded content will be deleted to allow new footage to be captured.
- **30 minutes:** Record a video for 30 minutes and save the video at 5-minute intervals. The beginning of the previously recorded content will be deleted to allow new footage to be captured.
- **60 minutes:** Record a video for 60 minutes and save the video at 5-minute intervals. The beginning of the previously recorded content will be deleted to allow new footage to be captured.
- **Maximum:** Record a video and save the video at 5-minute intervals until the memory card is full. The beginning of the previously recorded content will be deleted to allow new footage to be captured.



The saving time of videos may differ depending on the memory card's capacity.

## Using the mobile device

1 Launch the **Samsung Gear 360** app on the mobile device.

For iOS devices, launch the **Gear 360** app.

2 Tap **Camera**.

The viewfinder will appear.

3 Tap **MODE** → **Video looping**.

4 Tap  to record a video.

5 Tap  to finish recording the video.

The video will be saved in the Gear **360**'s memory card.

## Using the Gear 360

- 1 Press the Menu key until **Video looping** appears on the camera status screen, and then press the OK key to select it.

The recording cycle will appear on the camera status screen.



To change the recording cycle, select **Settings** → **Mode settings** → **Video loop recording time** on the Gear 360 or tap  on the connected mobile device's viewfinder.

- 2 Press the OK key to record a video.
- 3 Press the OK key to finish recording the video.

The video will be saved in the Gear 360's memory card.

## Landscape HDR

Automatically take three photos, combine them, and then calibrate the colours. The dark or bright parts of photos can be expressed with rich colours.



- In the Landscape HDR mode, photos may be blurred if they are taken while the camera or subjects are moving. Place the Gear 360 on a flat surface or use a tripod to take photos.
- It may take some time to calibrate colours.

## Using the mobile device

- 1 Launch the **Samsung Gear 360** app on the mobile device.

For iOS devices, launch the **Gear 360** app.

- 2 Tap **Camera**.

The viewfinder will appear.

3 Tap **MODE** → **Landscape HDR**.

4 Tap  to take a photo.

The photo will be saved in the Gear 360's memory card.



The available number of photos you can take will be shown on the camera status screen.

## Using the Gear 360

1 Press the Menu key until **Landscape HDR** appears on the camera status screen, and then press the OK key to select it.

2 Press the OK key to record a video.

The photo will be saved in the Gear 360's memory card.



- The available number of photos you can take will be shown on the camera status screen.
- The total number of remaining photos may not appear to decrease after taking photos, depending on the Gear 360's settings.



## Live Broadcast

Invite your family and friends to watch the videos you record with the Gear 360 in real time.



- This feature may not be available depending on the mobile device, software version, or service region.
- You may incur additional charges for broadcasting via the mobile network.
- Do not broadcast live videos in places where you may violate other people's privacy.

### Starting your broadcast

- 1 Launch the **Samsung Gear 360** app on the mobile device.
- 2 Tap **Live broadcast**, select the service you want to use, and then sign in to the account.  
The broadcast standby screen will appear. You can set your broadcast to be public or private.
- 3 Tap  to invite contacts.  
When the broadcast starts, the video link will be sent to the selected contacts via message. The invited contacts can watch the broadcast by tapping the link.
- 4 Tap  to start broadcasting.
- 5 Tap  to end your broadcast.  
You can upload the live video or share the live video's link with others.

### Watching a live broadcast

Invited contacts can watch the broadcast by tapping the video link they received. For public broadcasts, viewers can search for your channel name on the service they use.

During your broadcast, viewers can add comments and choose to like or dislike your broadcast.



Some features may be different depending on the service provider.

## Configuring camera settings

### Configuring settings on your mobile device

You can configure camera settings from the viewfinder of the connected mobile device. On the mobile device, tap the **Samsung Gear 360** app or the **Gear 360** app → **Camera**.

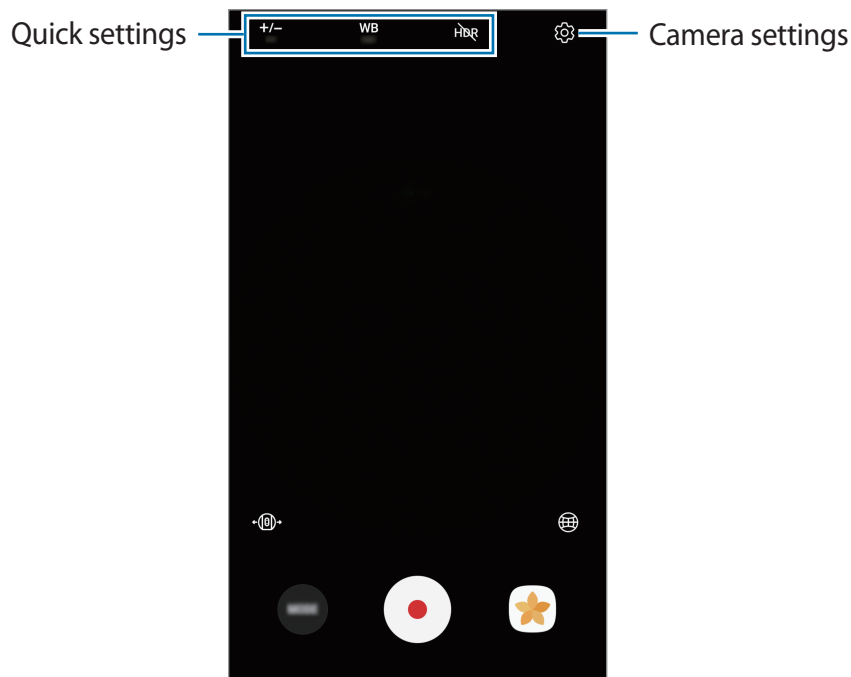



### Quick settings

You can use the following options on the connected mobile device's viewfinder.



The available options may vary depending on the shooting mode and which camera is being used.

- **+/-** : Change the exposure value. This determines how much light the camera's sensor receives. For low-light situations, use a higher exposure.
- **WB** : Select an appropriate white balance, so images have a true-to-life colour range.
- **HDR** : Take photos with rich colours and reproduce details even in areas with different exposure values.
-  : Set recording intervals while recording time lapse videos. Short intervals are suitable when recording a video of a fast-moving object and long intervals are suitable when recording a video of a slow-moving object, such as the setting sun or clouds.
-  : Set the recording cycle while recording a video looping.

## Camera settings

Tap  on the viewfinder or select **Settings** → **Camera settings** on the Samsung Gear 360 app or the Gear 360 app screen.



The available options may vary depending on the shooting mode and which camera is being used.

- **Photo size:** Select a resolution for photos. Using a higher resolution will result in higher quality photos, but they will take up more memory.
- **Video size:** Select a resolution for videos. Using a higher resolution will result in higher quality videos, but they will take up more memory.
- **Default lens view:** When you use the dual lens, select which lens screen from the rear or front lens to appear in the centre or preview.
- **Timer:** Select the length of the delay before the camera automatically takes a photo.
- **ISO sensitivity limit:** Set a limit for the ISO value. This controls camera light sensitivity. Low values are for stationary or brightly lit objects. Higher values are for fast-moving or poorly lit objects. However, higher ISO settings can result in noise in photos.
- **Sharpness:** Set the sharpness of your photos.
- **Reduce wind noise:** Reduce the permitted range of background noise during recording to improve sound quality.
- **Location tags:** Attach a GPS location tag to the photo.



- If you want to use the location tags feature, connect the Gear 360 to your mobile device.
- GPS signal strength may decrease in locations where the signal is obstructed, such as between buildings or in low-lying areas, or in poor weather conditions.
- Your location may appear on your photos when you upload them to the Internet. To avoid this, deactivate the location tag setting.

## Configuring settings on the Gear 360

Press the Menu key until **Settings** appears on the camera status screen, and then press the OK key to select it. Press the Menu key until the settings option you want to change appears, and then press the OK key to select it.





On the Gear 360, you can configure settings, such as the camera which is being used, the photo size, video size, timer, time lapse interval, recording cycle for video looping, and the auto power off option.

## Viewing videos or images

### Viewing videos

View the recorded videos on the remotely connected mobile device.

- 1 Launch the **Samsung Gear 360** app on the mobile device.  
For iOS devices, launch the **Gear 360** app.
- 2 Tap **Gallery**.
- 3 Tap **PHONE** or **GEAR 360**.
  - **PHONE**: View videos saved on your mobile device.
  - **GEAR 360**: View videos saved on the Gear 360's memory card.
- 4 Select a video and tap the play icon.
  - : Videos recorded by a single lens
  - : 360-degree videos recorded by dual lensesThe video will start playing.
- 5 During playback, spread two fingers apart on the screen to zoom in, and pinch them together to zoom out.  
To rewind or fast-forward the video, drag the play bar. Tap the point on the play bar that you want to skip to view that section of the video.

### Viewing 360-degree videos

You can use additional features when viewing 360-degree videos recorded by both the front and rear cameras.

### Viewing videos from different angles

During playback, drag your finger across the screen in any direction you want. You can change the viewing angle vertically and horizontally in a 360-degree range.





## Using the motion view feature

You can also view the video from different angles using the motion feature. During playback, tap **Motion view** and tilt or lightly shake the device.

To deactivate the motion feature, tap **Motion view**.

## Changing view mode

During playback, tap **360° view**, **Round view**, **Stretched view**, **Dual view** or **Panoramic view** to change the view mode.

-  **360° view**: Display the image spherically.
-  **Round view**: Display the image as an inverted panorama.
-  **Stretched view**: Display the image with a stretched view.
-  **Dual view**: Split the image to display each of the front and rear cameras' screens.
-  **Panoramic view**: Display the image with a wide view.



In the 360° view, Round view, and Stretched view modes, you can view images from different angles by dragging your finger across the screen in any direction. To reset the angle to the default setting, tap **Reset view**.

## Viewing photos

View the taken images on the remotely connected mobile device.

- 1 Launch the **Samsung Gear 360** app on the mobile device.  
For iOS devices, launch the **Gear 360** app.
- 2 Tap **Gallery**.
- 3 Tap **PHONE** or **GEAR 360**.
  - **PHONE**: View images saved on your mobile device.
  - **GEAR 360**: View images saved on the Gear **360**'s memory card.
- 4 Select an image. If the image was taken by dual lenses, the  icon will appear on the preview screen.



5 If the image was taken by dual lenses, tap .

One image taken by the front camera and another from the rear camera will be stitched together to create a 360-degree image.

## Viewing 360-degree images

You can use additional features when viewing 360-degree images taken by both the front and rear cameras.

### Viewing images from different angles

Drag your finger across the screen in any direction you want. You can change the viewing angle vertically and horizontally in a 360-degree range.





### Using the motion view feature

You can also view the image from different angles using the motion feature. While viewing the image, tap **Motion lock** and tilt or lightly shake the device.

To deactivate the motion feature, tap **Motion view**.

### Changing view mode

While viewing an image, tap **360° view**, **Round view**, **Stretched view**, **Dual view** or **Panoramic view** to change the view mode.

-  **360° view**: Display the image spherically.
-  **Round view**: Display the image as an inverted panorama.
-  **Stretched view**: Display the image with a stretched view.
-  **Dual view**: Split the screen to display each of the front and rear cameras' screens.
-  **Panoramic view**: Display the image with a wide view.



In the 360° view, Round view, and Stretched view modes, you can view images from different angles by dragging your finger across the screen in any direction. To reset the angle to the default setting, tap **Reset view**.

## Deleting videos or images

On the Samsung Gear 360 app or the Gear 360 app screen, tap **Gallery**, select the videos or photos you want to delete, and then tap **Delete**.

To delete multiple videos or images, tap and hold a video or an image to delete, select multiple videos or images, and then tap **DELETE**. For iOS devices, tap **Select** and select the files to delete and then tap **Delete**.

## Saving videos and images to the mobile device

You can save videos and images captured by the Gear 360 to your mobile device.

On the Samsung Gear 360 app or the Gear 360 app screen, tap **Gallery** → **GEAR 360**, select videos and images to save, and then tap **Save**. The videos and images will be saved in the mobile device.

You can view the saved files in **PHONE**.



- The resolution of videos and images may be reduced depending on whether your mobile device supports high resolutions.
- When you save 360-degree videos to your mobile device, the file size will be larger due to the use of a different video compression method.
- You can change the storage location to the mobile device or the mobile device's memory card from **Gallery settings**.

## Sharing videos or images

Select the videos or photos you want to share, tap **Share**, and then select a sharing method.



You can only share videos and images saved in **PHONE**.

## Editing videos and photos

### Saving 360-degree photos as standard photos

While viewing a 360-degree photo, tap  → **Save as standard picture**.

The 360-degree photo will be saved as the standard photo.



- The photo will be saved differently depending on the view mode or angle.
- You can view saved photos in **PHONE**.
- This feature may not be available depending on your mobile device or software version.

### Saving 360-degree videos as standard videos

While viewing a 360-degree video, tap  → **Save as standard video**.

The 360-degree video will be saved as the standard video.



- The video will be saved differently depending on the view mode or angle.
- You can view saved videos in **PHONE**.
- You can save 360-degree videos as standard videos only if they are saved in **PHONE**.
- This feature may not be available depending on your mobile device or software version.

### Trimming videos

Select a video from the list and tap **Trim**.

Drag the start bracket and the end bracket to the desired points to set the duration of the video to be played, and then tap **SAVE**.



- You can view edited videos in **PHONE**.
- You can only edit videos saved in **PHONE**.

## Capturing images from 360-degree videos

While viewing a 360-degree video, tap  → **Capture frame**. The  icon will appear on the screen. Tap  to capture the current screen.

Alternatively, you can capture the screen after selecting the frame you want to capture. Tap < or > to select the frame to capture, and then tap .



- You can view captured images in **PHONE**.
- You can only capture videos saved in **PHONE**.

## Viewing videos and images using the Gear VR

You can enjoy a more lively 360-degree screen when viewing 360-degree videos and images using the Gear VR.



- This feature may not be supported depending on the mobile device or software version.

## Installing and signing in to the Oculus app

To view videos and images captured by the Gear **360** on the Gear VR, install the Oculus app on the connected mobile device, and then sign in to your Oculus account.

- 1 Connect your mobile device to the Gear VR.
- 2 When a voice prompt requests you to separate the mobile device from the Gear VR, remove the mobile device.
- 3 Follow the on-screen instructions on the mobile device to complete the installation.
- 4 When the sign-in screen appears, sign in to your Oculus account.



- Refer to the Gear VR's manual for more information about connecting the mobile device to the Gear VR and the installation process.
- This content is based on the Gear VR (SM-R**324**) but some content may differ from the Gear VR's manual.

## Viewing 360-degree videos and photos on the Gear VR

You can only view the Gear 360's content saved in the connected mobile device.

- 1 Save videos and images captured by the Gear 360 to the mobile device.
  - **Method 1:** On the mobile device, tap the **Samsung Gear 360** app → **Gallery** → **GEAR 360**, select files to save, and then tap **Save**.
  - **Method 2:** On the mobile device, tap **My Files** → **Internal storage** → **DCIM** → **Gear 360**, and then save files.
- 2 On the mobile device, sign in to your Oculus account.
- 3 On the mobile device, tap the **Samsung Gear 360** app → **Gallery** → **PHONE** →  → **View on Gear VR**.
- 4 Connect the mobile device to the Gear VR.

The list of content saved in the mobile device will appear on the Gear VR screen.
- 5 Select content to view using the touchpad on the Gear VR.

You can enjoy the videos and images in a 360-degree view.



Refer to the Gear VR's manual for more information about viewing content using the touchpad.

## Using the computer program

On your computer, you can watch videos or create 360-degree videos by stitching together wide-angle videos taken with the front and rear cameras. You can broadcast live videos in real time.

Windows OS supports the Gear 360 ActionDirector program and Mac OS supports the Gear 360 program. You can download these programs from [www.samsung.com](http://www.samsung.com). For more information, refer to the program's help menu.

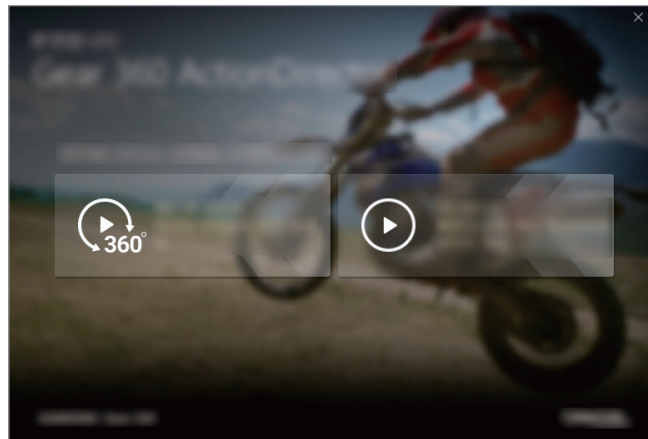

- The Gear 360 ActionDirector program provides the video editing feature.
- When turning the Gear 360 on after connecting it to your computer via a USB cable, user authentication will be performed automatically.

## Transferring files to a computer

You can transfer files from the Gear 360 to a computer using the Gear 360 as a removable disk for data transfer.



Do not disconnect the USB cable from the device when you are transferring files. Doing so may cause data loss or device damage.



The devices may not connect properly if they are connected via a USB hub. Directly connect the device to the computer's USB port.

1 Connect the Gear 360 to the computer using the USB cable.  
The Gear 360 will be recognised as a removable disk.

2 Transfer files between your Gear 360 and the computer.

## Configuring the settings

You can configure settings for the Gear 360 and the app.

On the mobile device, tap the **Samsung Gear 360** app or the **Gear 360** app → **Settings**.

### GEAR 360

- **Sound and LED:** Change the notification sound and the light settings.
  - **Volume:** Adjust the notification sound volume or mute the sound.
  - **LED indicator:** Set the indicator light and camera status light to turn on or off.



Even when **LED indicator** is deactivated, the indicator light will turn on in the following situations:

- Battery power is low
- Charging
- Fully charged
- Overheating

- **Auto power off after:** Set the length of time the Gear 360 waits before turning off.



When you do not use the auto shut-off feature, the battery will be charged only when the Gear 360 is turned off.

- **Battery status:** View the battery charging status.
- **Storage:** Check the memory card's used and available memory capacity.
- **Reset and format:** Format a memory card or reset the Gear 360.



This feature does not appear when a memory card is not inserted or a memory card error occurs.

- **Firmware version:** View the software version of the Gear 360 and update the software.

## GEAR 360 APP

- **Camera settings:** Configure the camera settings.
- **Gallery settings:** Change the save settings.
  - **Tilt correction:** Adjust the tilt of photos and videos when saving them on your mobile device.



This feature automatically straightens captured videos and photos when you save them on your mobile device, so playback may differ from your intended purpose. Turn off this feature when you record videos or take photos by moving the Gear 360 or with a purposely tilted angle.

- **Storage location:** Select the storage location for photos and videos.
- **About Gear 360 App:** View the app's information or update the software.



## Updating the software

The Gear 360 and app can be updated to the latest software.

### Updating the Gear 360

You can remotely update the Gear 360's firmware using the mobile device.

On the mobile device, tap the **Samsung Gear 360** app or the **Gear 360** app → **Settings** → **Firmware version** → **CHECK FOR UPDATES**.



- Ensure that the Gear 360 and the mobile device are sufficiently charged before updating the firmware.
- Ensure that the Gear 360 and the mobile device are connected.
- Do not turn off the Gear 360 or mobile device while updating the firmware.

### Updating the app

On the mobile device, tap the **Samsung Gear 360** app or the **Gear 360** app → **Settings** → **About Gear 360 App** → **UPDATE NOW**.

# Appendix

## Troubleshooting

Before contacting a Samsung Service Centre, please attempt the following solutions. Some situations may not apply to your Gear 360.

### Your Gear 360 does not turn on

When the battery is completely discharged, your Gear 360 will not turn on. Charge the battery completely before turning on the Gear 360.

### Another Bluetooth or Wi-Fi device cannot locate your Gear 360

- Ensure that your Gear 360 enters Bluetooth or Wi-Fi pairing mode. Press and hold the Menu key. Then, when **Connect to Android**, or **Connect to iOS** appears on the camera status screen, press the OK key to enter Bluetooth or Wi-Fi pairing mode.
- Ensure that your Gear 360 and the mobile device to connect with are within the Bluetooth connection range (10 m) or the Wi-Fi connection range (5 m).

If the tips above do not solve the problem, contact a Samsung Service Centre.

### A Bluetooth connection is not established or your Gear 360 and the mobile device are disconnected

- Ensure there are no obstacles, such as walls or electrical equipment, between the devices.
- Ensure that the latest version of the Samsung Gear 360 app or the Gear 360 app is installed on the mobile device. Update the Samsung Gear 360 app or the Gear 360 app if it is not up to date.
- Ensure that your Gear 360 and the other Bluetooth device are within the Bluetooth connection range (10 m). The distance may vary depending on the environment the devices are used in.
- Restart both devices and launch the **Samsung Gear 360** app or the **Gear 360** app on the mobile device again.

## The battery icon is empty

Your battery is low. Charge the battery.

## The battery does not charge properly (For Samsung-approved chargers)

- Ensure that the charger is connected properly.
- Visit a Samsung Service Centre and have the battery replaced.

## The battery depletes faster than when first purchased

- When you expose the Gear 360 or the battery to very cold or very hot temperatures, the useful charge may be reduced.
- The battery is consumable and the useful charge will get shorter over time.

## The time on the Gear 360 has been reset

The time will be reset when you update the Gear 360. You can set the time by connecting it to the mobile device via Bluetooth.

## Your Gear 360 is hot to the touch

When using the Gear 360 for an extended period, the Gear 360 and its battery may heat up. If the temperature rises above a certain level, the Gear 360 will stop recording and turn off automatically to prevent damage. If the Gear 360 is turned off due to overheating, wait for it to cool down before resuming use.

## The memory card icon appears on the camera status screen

- Ensure that a memory card is inserted.
- Ensure that your memory card is not damaged.

## Data stored in the Gear 360 has been lost

Always make backup copies of all important data stored in the Gear 360. Otherwise, you cannot restore data if it is corrupted or lost. Samsung is not responsible for the loss of data stored in the Gear 360.

## A small gap appears around the outside of the Gear 360 case

- This gap is a necessary manufacturing feature and some minor rocking or vibration of parts may occur.
- Over time, friction between parts may cause this gap to expand slightly.

## The lens is dirty

Wipe the lens in a circular motion with a clean, soft cloth.

## Removing the battery

- To remove the battery, contact an authorised service centre. To obtain battery removal instructions, please visit [www.samsung.com/global/ecodesign\\_energy](http://www.samsung.com/global/ecodesign_energy).
- For your safety, you **must not attempt to remove** the battery. If the battery is not properly removed, it may lead to damage to the battery and device, cause personal injury, and/or result in the device being unsafe.
- Samsung does not accept liability for any damage or loss (whether in contract or tort, including negligence) which may arise from failure to precisely follow these warnings and instructions, other than death or personal injury caused by Samsung's negligence.

## Copyright

Copyright © 2017 Samsung Electronics

This manual is protected under international copyright laws.

No part of this manual may be reproduced, distributed, translated, or transmitted in any form or by any means, electronic or mechanical, including photocopying, recording, or storing in any information storage and retrieval system, without the prior written permission of Samsung Electronics.

## Trademarks

- SAMSUNG and the SAMSUNG logo are registered trademarks of Samsung Electronics.
- Bluetooth® is a registered trademark of Bluetooth SIG, Inc. worldwide.
- Wi-Fi®, Wi-Fi Protected Setup™, Wi-Fi Direct™, Wi-Fi CERTIFIED™, and the Wi-Fi logo are registered trademarks of the Wi-Fi Alliance.
- All other trademarks and copyrights are the property of their respective owners.